



Operating Manual  
**ALTAIR® 2X**  
Single or Two Gas Detector



Order No.: 10148950/07  
Print Spec: 10000005389 (EO)  
CR: 800000059385

**⚠ WARNING!**

These instructions must be provided to users before use of the product and retained for ready reference by the user. Read this manual carefully before using or maintaining the device. The device will perform as designed only if it is used and maintained in accordance with the manufacturer's instructions. Otherwise, it could fail to perform as designed, and persons who rely on this device could sustain serious injury or death.

---

The warranties made by MSA with respect to the product are voided if the product is not installed and used in accordance with the instructions in this manual. Please protect yourself and your employees by following the instructions.

Please read and observe the WARNINGS and CAUTIONS inside. For additional information relative to use or repair, call 1-800-MSA-2222 during regular working hours.

For countries of Russian Federation, Republic of Kazakhstan and Republic of Belarus, the gas detector will be delivered with a passport document that includes valid approval information. On the CD with manual instruction attached to the gas detector the user will find the documents "Type Description" and "Test Method" - appendixes to Pattern Approval Certificate of Measuring instrument, valid in the countries of use.

The Declaration of Conformity can be found under the following link: <https://MSAsafety.com/DoC>.

MSA is a registered trademark of MSA Technology, LLC in the US, Europe and other Countries. For all other trademarks visit <https://us.msasafety.com/Trademarks>.



***The Safety Company***

1000 Cranberry Woods Drive  
Cranberry Township, PA 16066  
USA  
Phone 1-800-MSA-2222  
Fax 1-800-967-0398

For your local MSA contacts, please go to our website [www.MSAsafety.com](http://www.MSAsafety.com)

# Contents

<b>1</b>	<b>Safety Regulations</b> .....	<b>5</b>
1.1	Correct Use .....	5
1.2	Liability Information .....	5
1.3	Safety and Precautionary Measures .....	5
1.4	Warranty .....	7
<b>2</b>	<b>Description</b> .....	<b>8</b>
2.1	Overview .....	8
2.2	On-Screen Indicators .....	10
2.3	Sensor End of Life Warning .....	11
2.4	Sensor End of Life Alarm .....	11
2.5	Backlight .....	11
2.6	Fresh Air Setup (FAS) .....	11
2.7	Bump Test for Sensors with XCell Pulse Technology .....	11
<b>3</b>	<b>Use</b> .....	<b>12</b>
3.1	Environmental Factors .....	12
3.2	Settings .....	12
3.3	First Use .....	13
3.4	Turning ON the Device .....	14
3.5	Function Checks Before Use .....	22
3.6	Duration of Use .....	25
3.7	Monitoring Gas Concentration .....	26
3.8	Changing Alarm Setpoints .....	28
3.9	Displaying Device Data .....	28
3.10	IR mode .....	29
3.11	Turning OFF the Device .....	30
3.12	Data Logging .....	30
3.13	Calibration .....	30
3.14	Using the Device with a GALAXY GX2 Automated Test System .....	35
<b>4</b>	<b>Maintenance</b> .....	<b>36</b>
4.1	Troubleshooting .....	36
4.2	Replacing the Battery .....	37
4.3	Replacing the Sensor .....	38
4.4	Cleaning .....	39
4.5	Storage .....	39
4.6	Scope of Delivery .....	39
<b>5</b>	<b>Technical Data</b> .....	<b>40</b>
5.1	Technical Specifications .....	40
5.2	Sensor Data .....	40
5.3	Data Logging Specifications .....	42
<b>6</b>	<b>Certification</b> .....	<b>44</b>
6.1	Marking, Certificates and Approvals According to the Directive 2014/34/EU (ATEX) .....	45
6.2	Marking, Certificates and Approvals According to IECEx .....	46

<b>7</b>	<b>Ordering Information</b> .....	<b>47</b>
7.1	Calibration Gas Cylinders .....	47
7.2	Replacement Parts and Accessories .....	47
7.3	Sensor Replacement Kits .....	48

# 1 Safety Regulations

## 1.1 Correct Use

The ALTAIR 2X gas detector, hereafter referred to as device, is intended for use by trained and qualified personnel. It is designed to be used when performing a hazard assessment to:

- Assess potential worker exposure to toxic gases and vapors.
- Determine the appropriate gas and vapor monitoring needed for a workplace.

The ALTAIR 2X gas detector can be equipped for:

- Detecting specific toxic gases for which a sensor is installed

It is imperative that this operating manual be read and observed when using the device. In particular, the safety instructions, as well as the information for the use and operation of the device, must be carefully read and observed. Furthermore, the national regulations applicable in the user's country must be taken into account for a safe use.

### **WARNING!**

This product is supporting life and health. Inappropriate use, maintenance or servicing may affect the function of the device and thereby seriously compromise the user's life.

Before use the product operability must be verified. The product must not be used if the function test is unsuccessful, it is damaged, a competent servicing/maintenance has not been made, genuine MSA spare parts have not been used.

**Failure to follow this warning can result in serious personal injury or death.**

---

Alternative use, or use outside this specification will be considered as non-compliance. This also applies especially to unauthorised alterations to the product and to commissioning work that has not been carried out by MSA or authorised persons.

## 1.2 Liability Information

MSA accepts no liability in cases where the product has been used inappropriately or not as intended. The selection and use of this product must be under the direction of a qualified safety professional who has carefully evaluated the specific hazards of the jobsite where it will be used and who is completely familiar with the product and its limitations. The selection and use of this product and its incorporation into the safety scheme of the jobsite is the exclusive responsibility of the Employer.

Product liability claims, warranties also as guarantees made by MSA with respect to the product are voided, if it is not used, serviced or maintained in accordance with the instructions in this manual.

## 1.3 Safety and Precautionary Measures

### **WARNING!**

The following safety instructions must be followed implicitly. Misuse can result in loss of life or serious injury.

**Failure to follow this warning can result in serious personal injury or death.**

---

### **Use Device only for Assigned Gases**

The device must be used only for gases for which a sensor is installed in the device.

**Check Function**

Before each day's use, check the function of the device (→ chapter 3.5). MSA recommends carrying out a routine inspection prior to each day's use.

**Perform a Bump Test**

Bump test frequency is often stipulated by national or corporate regulations; however, bump testing before each day's use is generally the accepted best safety practice and is therefore MSA's recommendation. The device must pass the bump test. If it fails the test, perform a calibration before using the device.

Perform a bump test more frequently if the device is subjected to physical shock or high levels of contaminants.

**Check Function and Alarm before Each Use**

In case of failed function tests, the device must be removed from use.

**Check Confidence Indicator**

The Confidence indicator must flash every 15 seconds after starting the device.

**Defective Vibrating Alarm Possible**

At ambient temperatures  $< 0\text{ }^{\circ}\text{C}$ , the vibrating alarm can give a false alarm or can fail completely. In such conditions, do not rely solely on the vibrating alarm.

**Physical Shock**

Perform a calibration if device is subjected to physical shock.

**Sensor Maintenance**

Do not block sensor opening as this may cause inaccurate readings. Do not press on the face of the sensor, as this may damage it and cause erroneous readings. Do not use compressed air to clean the sensor holes, as the pressure may damage the sensor.

**Observe Proper Time for Display Stabilizing**

Allow sufficient time for device to display accurate reading. Response times vary based on the type of sensor being utilized.

**Be Aware of Environmental Conditions**

A number of environmental factors may affect the sensor readings, including changes in pressure, humidity and temperature.

**Be Aware of the Procedures for Handling Electrostatically Sensitive Electronics**

The device contains electrostatically sensitive components. Do not open or repair the device without using appropriate electrostatic discharge (ESD) protection. The warranty does not cover damage caused by electrostatic discharges.

**Be Aware of the Product Regulations**

Follow all relevant national regulations applicable in the country of use.

## Be Aware of the Warranty Regulations

The warranties made by Mine Safety Appliances Company with respect to the product are voided if the product is not used and maintained in accordance with the instructions in this manual. Please protect yourself and others by following them. We encourage our customers to write or call regarding this equipment prior to use or for any additional information relative to use or service.

### Accessible Metal Parts

The device enclosure includes accessible metal part. The end user shall determine suitability in the specific application. The measured capacitance of the device on the belt clip is 40 pF.

## 1.4 Warranty

ITEM	WARRANTY PERIOD
Chassis and electronics	Three years
H <sub>2</sub> S, CO, SO <sub>2</sub> , NO <sub>2</sub> sensors	Three years
Cl <sub>2</sub> , NH <sub>3</sub> sensors	Two years

Specific battery run-time over temperature is not warranted.

This warranty does not cover filters, fuses or replaceable batteries. This warranty is valid only if the product is maintained and used in accordance with Seller's instructions and/or recommendations.

The Seller shall be released from all obligations under this warranty in the event repairs or modifications are made by persons other than its own or authorized service personnel or if the warranty claim results from physical abuse or misuse of the product. No agent, employee or representative of the Seller has any authority to bind the Seller to any affirmation, representation or warranty concerning this product. Seller makes no warranty concerning components or accessories not manufactured by the Seller, but will pass on to the Purchaser all warranties of manufacturers of such components.

**THIS WARRANTY IS IN LIEU OF ALL OTHER WARRANTIES, EXPRESSED, IMPLIED OR STATUTORY, AND IS STRICTLY LIMITED TO THE TERMS HEREOF. SELLER SPECIFICALLY DISCLAIMS ANY WARRANTY OF MERCHANTABILITY OR OF FITNESS FOR A PARTICULAR PURPOSE.**

### Exclusive Remedy

It is expressly agreed that Purchaser's sole and exclusive remedy for breach of the above warranty, for any tortious conduct of Seller, or for any other cause of action, shall be the replacement at Seller's option, of any equipment or parts thereof, which after examination by Seller is proven to be defective.

Replacement equipment and/or parts will be provided at no cost to Purchaser, F.O.B. Seller's Plant. Failure of Seller to successfully replace any nonconforming equipment or parts shall not cause the remedy established hereby to fail of its essential purpose.

### Exclusion of Consequential Damage

Purchaser specifically understands and agrees that under no circumstances will seller be liable to purchaser for economic, special, incidental or consequential damages or losses of any kind whatsoever, including but not limited to, loss of anticipated profits and any other loss caused by reason of non-operation of the goods. This exclusion is applicable to claims for breach of warranty, tortious conduct or any other cause of action against seller.

## 2 Description

### 2.1 Overview



Figure 1 Device view

- |                    |                             |
|--------------------|-----------------------------|
| 1 Alarm LED (red)  | 5 Button                    |
| 2 Infrared port    | 6 Display with backlight    |
| 3 Sensor cover     | 7 Gas type                  |
| 4 Safe LED (green) | 8 Audible alarm transmitter |

The device monitors gases in ambient air and in the workplace. The following toxic gases can be monitored in the ambient air:

- Sulfur dioxide (SO<sub>2</sub>)
- Nitrogen dioxide (NO<sub>2</sub>)
- Carbon monoxide (CO)
- Hydrogen sulfide (H<sub>2</sub>S)
- Chlorine (Cl<sub>2</sub>)
- Ammonia (NH<sub>3</sub>)

The Two Gas (Two-Tox) sensor provides two sensing capabilities in a single sensor. The following combinations are possible:

- Carbon monoxide/hydrogen sulfide (CO/H<sub>2</sub>S)
- Carbon monoxide/nitrogen dioxide (CO/NO<sub>2</sub>)



## 2 Description

- Hydrogen sulfide/sulfur dioxide (H<sub>2</sub>S/SO<sub>2</sub>)

The alarm levels for the individual gases are factory-set and cannot be changed during operation. Changes can only be made through MSA Link software.

### Short Term Exposure Limits (STEL)

The STEL alarm is calculated over a 15 minute exposure.

STEL calculation examples:

Assume the device has been running for at least 15 minutes:

#### 15 minute exposure of 35 ppm:

$$\frac{(15 \text{ minutes} \times 35 \text{ ppm})}{15 \text{ minutes}} = 35 \text{ ppm}$$

#### 10 minute exposure of 35 ppm and 5 minutes exposure of 5 ppm:

$$\frac{(10 \text{ minutes} \times 35 \text{ ppm}) + (5 \text{ minutes} \times 5 \text{ ppm})}{15 \text{ minutes}} = 25 \text{ ppm}$$

If the device is on for longer than 15 minutes, the STEL is calculated for the most recent fifteen minutes of runtime.

### Time Weighted Average (TWA)

The TWA alarm is calculated over an eight-hour exposure.

TWA calculation examples:

#### 1 hour exposure of 50 ppm:

$$\frac{(1 \text{ hour} \times 50 \text{ ppm}) + (7 \text{ hours} \times 0 \text{ ppm})}{8 \text{ hours}} = 6.25 \text{ ppm}$$

#### 4 hour exposure of 50 ppm and 4 hour exposure of 100 ppm:

$$\frac{(4 \text{ hours} \times 50 \text{ ppm}) + (4 \text{ hours} \times 100 \text{ ppm})}{8 \text{ hours}} = 75 \text{ ppm}$$

#### 12 hour exposure of 100 ppm:

$$\frac{(12 \text{ hours} \times 100 \text{ ppm})}{8 \text{ hours}} = 150 \text{ ppm}$$

If the device is ON for less than 8 hours (480 minutes), the balance of the minute ppm values is set to zero.

2.2 On-Screen Indicators

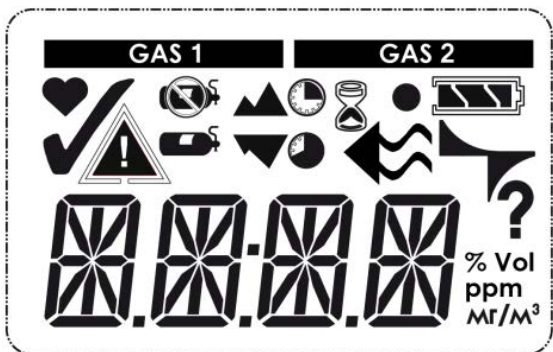





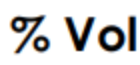
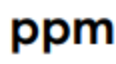



Figure 2 Display

	Only displayed for two gas detectors. The label above this bar shows which gas concentration is currently displayed
	Sensor life Symbol – Indicates the end of sensor life
	Bump Check Symbol – Indicates successful bump test or calibration
	Alarm Symbol – Indicates alarm state.
	No Gas Cylinder – Indicates cal gas should not be applied and device must be exposed to fresh air
	Cal Gas Cylinder – Indicates cal gas must be applied
	PEAK Symbol – Indicates a PEAK reading or high alarm
	Minimum – Indicates a minimum value or low alarm
	Short Term Exposure Limit (STEL) Symbol – Indicates a STEL alarm
	Time Weighted Average (TWA) Symbol – Indicates a TWA alarm
	Hourglass – Indicates user should wait
	Device confidence indicator

	Flow check symbol - Indicates that a flow check is being prepared or should be executed
	Battery condition - Indicates the battery charge level
	Indicates a battery alarm when flashing
	Electronic pulse check symbol - Indicates a currently running electronic check of the sensor
	Indicates required interaction
	Gas concentration
	Volume percent
	Parts per million
	mg/m <sup>3</sup>

### 2.3 Sensor End of Life Warning

If a sensor is nearing its end of life, the device will warn the user following a sensor calibration. The sensor is still fully functional at this point, but the warning gives the user time to plan for a replacement sensor and minimise downtime. The ♥ symbol will be continuously displayed.

### 2.4 Sensor End of Life Alarm

If a sensor fails two calibrations in a row, a sensor End of Life Alarm condition is present. The ♥ symbol will flash continuously.

### 2.5 Backlight

The backlight can be manually activated with a quick push of the button. The backlight remains ON for a certain time, depending on the instrument settings.

### 2.6 Fresh Air Setup (FAS)

This check eliminates background contaminants, reducing the possibility of inaccurate readings.

The Fresh Air Setup zeroes toxic gas sensors. The Fresh Air Setup will not function if it is activated in a non-fresh air environment. If a dangerous level of gas is present, the device will ignore the Fresh Air Setup and go into alarm.

### 2.7 Bump Test for Sensors with XCell Pulse Technology

Sensors with XCell Pulse Technology can be bump tested with a combination of a pulse check and a flow check.

First, the device carries out an electronic pulse check of the sensor. Second, the user executes a flow check by exhaling onto the face of the device.

## 3 Use

### 3.1 Environmental Factors

A number of environmental factors may affect the gas sensor readings, including changes in pressure, humidity and temperature.

#### Temperature Changes

The sensors have built-in temperature compensation. However, if temperature shifts dramatically, the sensor reading may shift. Zero the device at the work site temperature for the least effect.

### 3.2 Settings

Any changes of the device settings can only be carried out using the MSA Link™ software. Ensure that the latest version of the MSA Link software is used.

The MSA Link application is available free on [www.MSAsafety.com](http://www.MSAsafety.com).

#### Modes

<b>Always-On Mode</b>	<p>When Always-On mode is enabled, the device cannot be turned OFF with the ON/OFF button. There are three ways to power off the device when this mode is enabled:</p> <ul style="list-style-type: none"> <li>• Remove device battery, or</li> <li>• Disable Always-On mode via MSA Link software, or</li> <li>• Enable Sleep mode</li> </ul>
<b>Go/No-Go Mode</b>	<p>When Go/No-Go mode is enabled, the device does NOT display a numeric gas reading. Instead, the device displays "OK" unless it enters a gas alarm state. When in gas alarm, the device displays "XXXX".</p> <p>Although the gas exposure data is not displayed, that data is still recorded in the device's data log.</p>
<b>Motion Alert Mode</b>	<p>When Motion Alert mode is enabled, the device enters pre-alarm when no motion is detected for 20 seconds. This condition can be cleared by moving the device. After 30 seconds of inactivity, the full Motion Alert alarm is triggered. This alarm can only be cleared by pressing the button.</p> <p><b>NOTE:</b> When Motion Alert is enabled, it is not possible to enable Sleep mode.</p>
<b>Persistent Alarm Mode</b>	<p>When Persistent Alarm Mode is enabled, the device's red alarm LEDs continue to flash following a cleared gas alarm. The LEDs must be deactivated via an IR communication with MSA Link or with the MSA Galaxy GX2 automated test stand.</p>
<b>Sleep Mode</b>	<p>To save battery run time, the device can be setup to automatically go into sleep mode. If activated, the device will go into sleep mode if</p> <ul style="list-style-type: none"> <li>• The device has been continuously activated for at least 8 hours</li> <li>• The device has not detected any movement continuously for at least 2 hours -after the 8-hour minimum operation time has elapsed</li> <li>• The device has not seen any alarm or readings other than 0 ppm (mg/m<sup>3</sup>) during the 2 hours of no movement</li> </ul> <p>Before going into sleep mode, the device will show a warning to notify the user it will go into sleep mode if the device is not moved or no button is pressed. During sleep mode, the device will be inactive, not measuring gas and not displaying any readings. The device can be reactivated by either pressing the button or deliberately moving the device so that a noticeable movement can be detected.</p>

	<b>NOTE:</b> When Sleep Mode is enabled, it is not possible to enable Motion Alert.
<b>Operating Beep</b>	<p>This operating beep activates every 30 seconds by momentarily beeping the horn under the following conditions:</p> <ul style="list-style-type: none"> <li>• Operating beep is enabled</li> <li>• Device is in normal operating mode</li> <li>• Device is not in battery warning</li> <li>• Device is not in gas alarm</li> <li>• Audible and visual options are enabled</li> </ul>

### 3.3 First Use



Before the device can be used for monitoring possible toxic gases in the atmosphere, it must be commissioned (→ [Figure 3](#) and [Figure 4](#) ).

When switching on the device for the first time and after a battery replacement the device will initialize the battery. During a battery initialization, `BATT TEST` is shown on the display followed by a sequence of LED illuminations and activation of the vibration motor. The device then continues the start-up as described in section [3.4](#) .

1. Calibrate devices with XCell Pulse Technology before first use to ensure optimal sensor performance.

### 3.4 Turning ON the Device

1. Press the button.
  - All display segments are activated
  - Audible alarm sounds
  - Alarm LEDs light
  - Vibrating alarm is activated.

The device displays the following for a few seconds each:

- MSA
  - Software version
  - WAIT (Displayed for up to 20 seconds during sensor discovery)
  - If enabled: individual alarm indication settings
  - Gas type
  - Low alarm icon with low alarm setpoint
  - High alarm icon with high alarm setpoint
  - STEL alarm icon with STEL alarm setpoint
  - TWA alarm icon with TWA alarm setpoint
  - Calibration gas settings
2. If the LastCalDate page is enabled, the display will show the last cal date of the installed sensor (DD-MMM-YY).

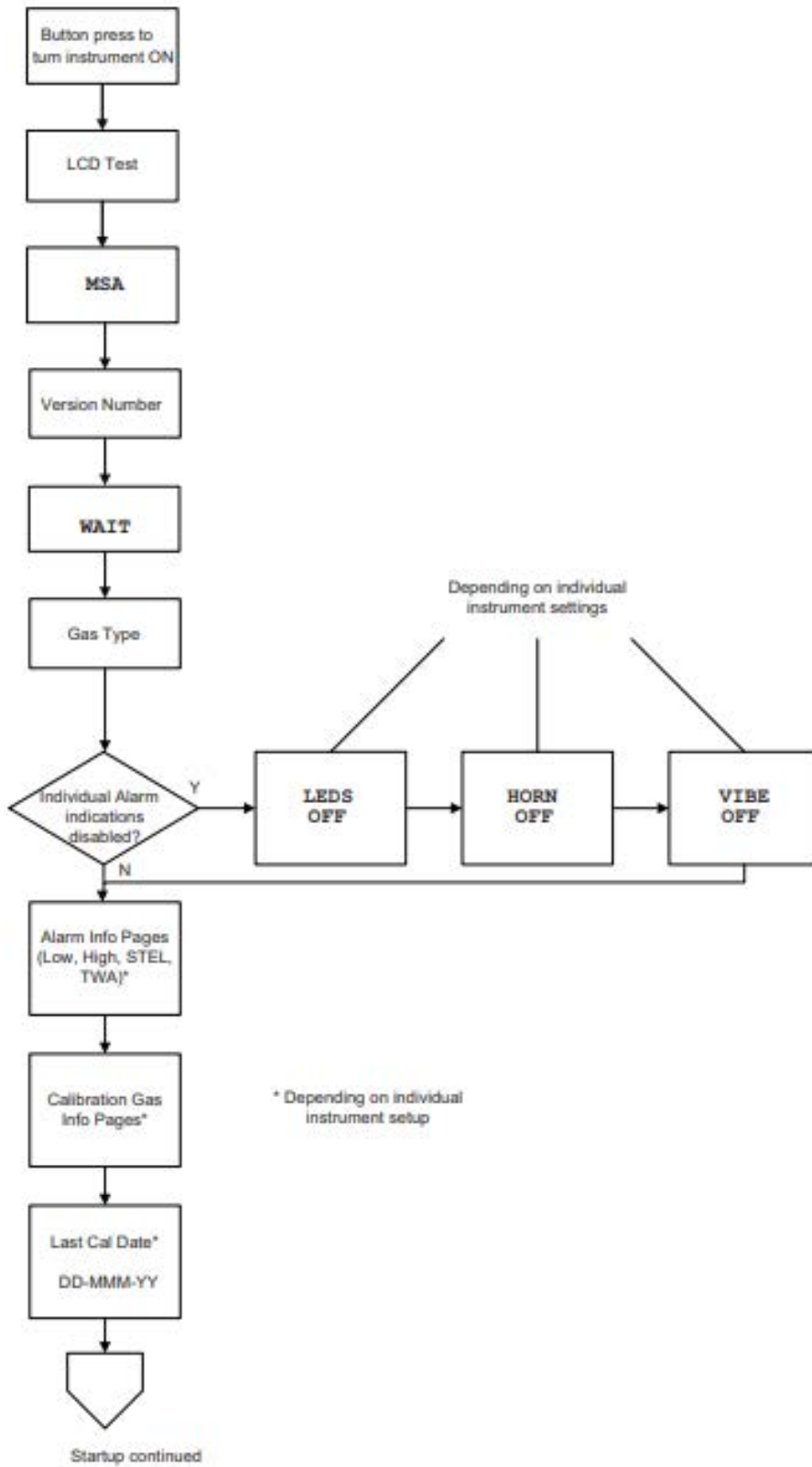

Figure 3 Startup

3. Fresh Air Setup prompt (FAS?)/Pulse Check start screen (PULSE) is displayed, depending on the sensor installed.

** WARNING!**

Only carry out the Fresh Air Setup/bump test in fresh, uncontaminated air; otherwise, inaccurate readings can falsely indicate a hazardous atmosphere as safe. If the quality of the surrounding air is uncertain, do not carry out a Fresh Air Setup/bump test. Do not use the Fresh Air Setup/bump test as a substitute for daily calibration checks. The calibration check is required to verify span accuracy.

**Failure to follow this warning can result in serious personal injury or death.**



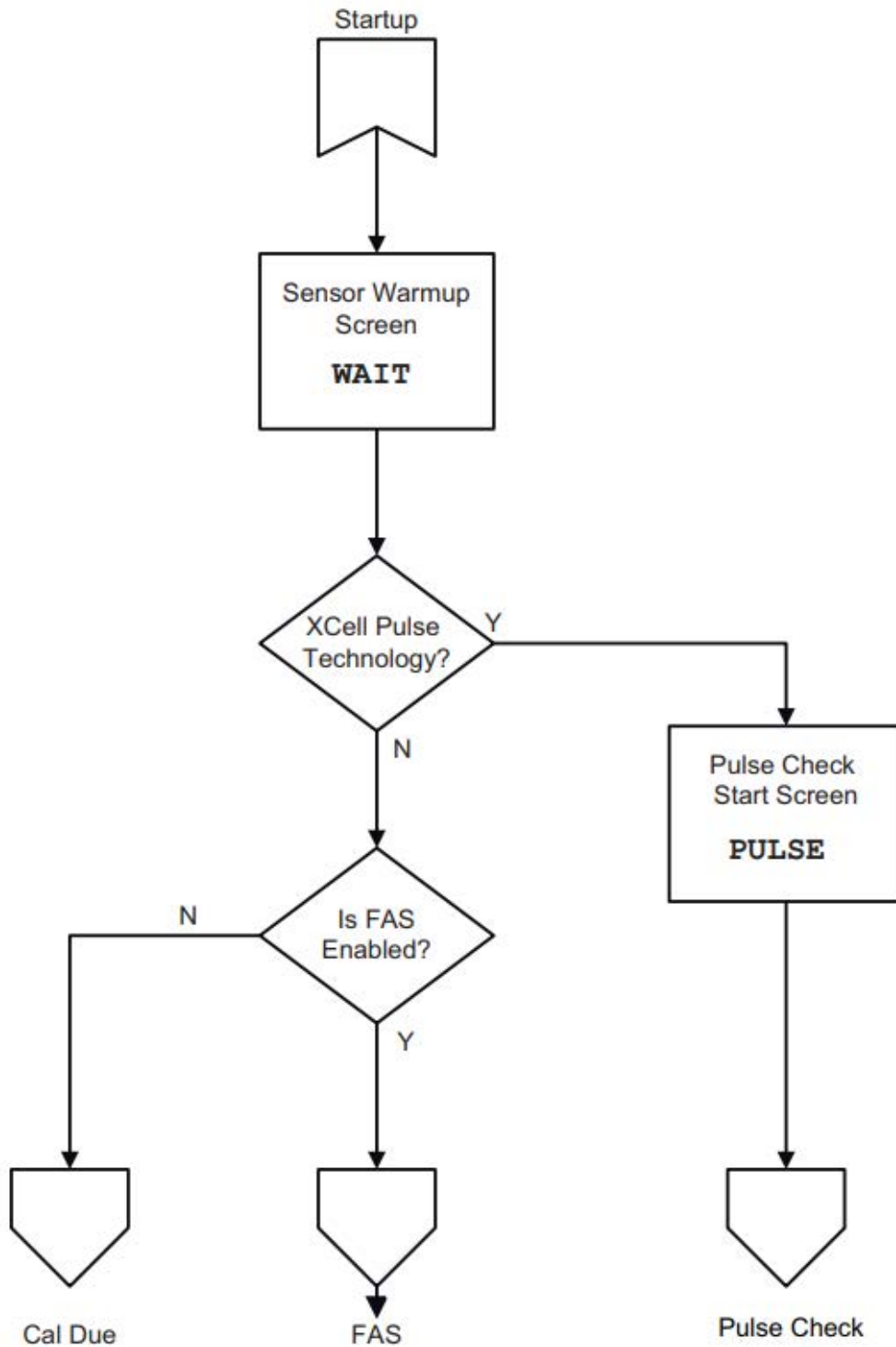

Figure 4 Startup, continued

### FAS

FAS? is displayed.

1. To start the FAS press the button while FAS? is displayed.

*The display will show the results of the setup, PASS or ERR.*

The fresh air setup has limits.



If a hazardous level of gas is present, the device displays ERR.

Press the button to acknowledge the error and perform a calibration.

### Bump Test for Devices with XCell Pulse Technology

This test will start automatically.

- PULSE is displayed shortly.
- The electronic pulse check icon and a countdown are displayed.
- At the end of the countdown, the results of the electronic pulse check are displayed (PASS or ERR).

If ERR:

1. Press the button to return to normal operating mode and perform a calibration.

If PASS:

- The display shows the Flow check icon and WAIT for followed by a countdown.

At the end of the countdown, the display will show FLOW and the green LEDs near the sensor will flash.

1. Exhale into the device.

*Hold device close to mouth (5 cm/2 inches distance) and blow forcefully onto the sensor opening for 2 seconds.*

The results of the test are then displayed (PASS or ERR).

If ERR:

1. Press the button to return to normal operating mode and perform inspection of sensor.
2. Repeat the bump test if necessary.
3. If the bump test fails, calibrate the device (→ Section 3.13).

If PASS:

- The device returns to normal operating mode.
- A ✓ is displayed for 24 hours to indicate that the self-test was successful.
- If the safe LED (green) option is enabled, the green LEDs will flash periodically.

To clean the sensor inlet before or after a flow test, only use approved cleaner described in section 7.

4. To bypass FAS, do **not** press the button.

*The device continues the ON sequence.*

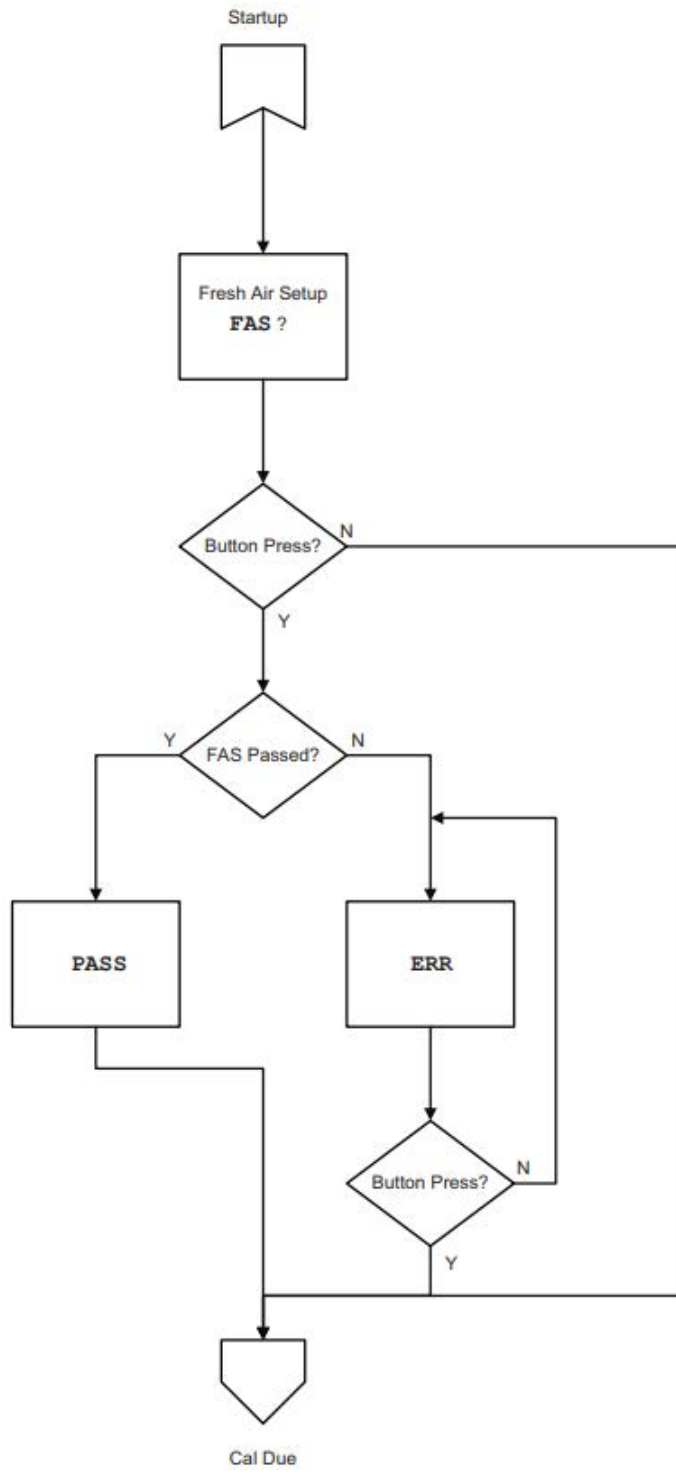

Figure 5 FAS (Devices without XCell Pulse technology)

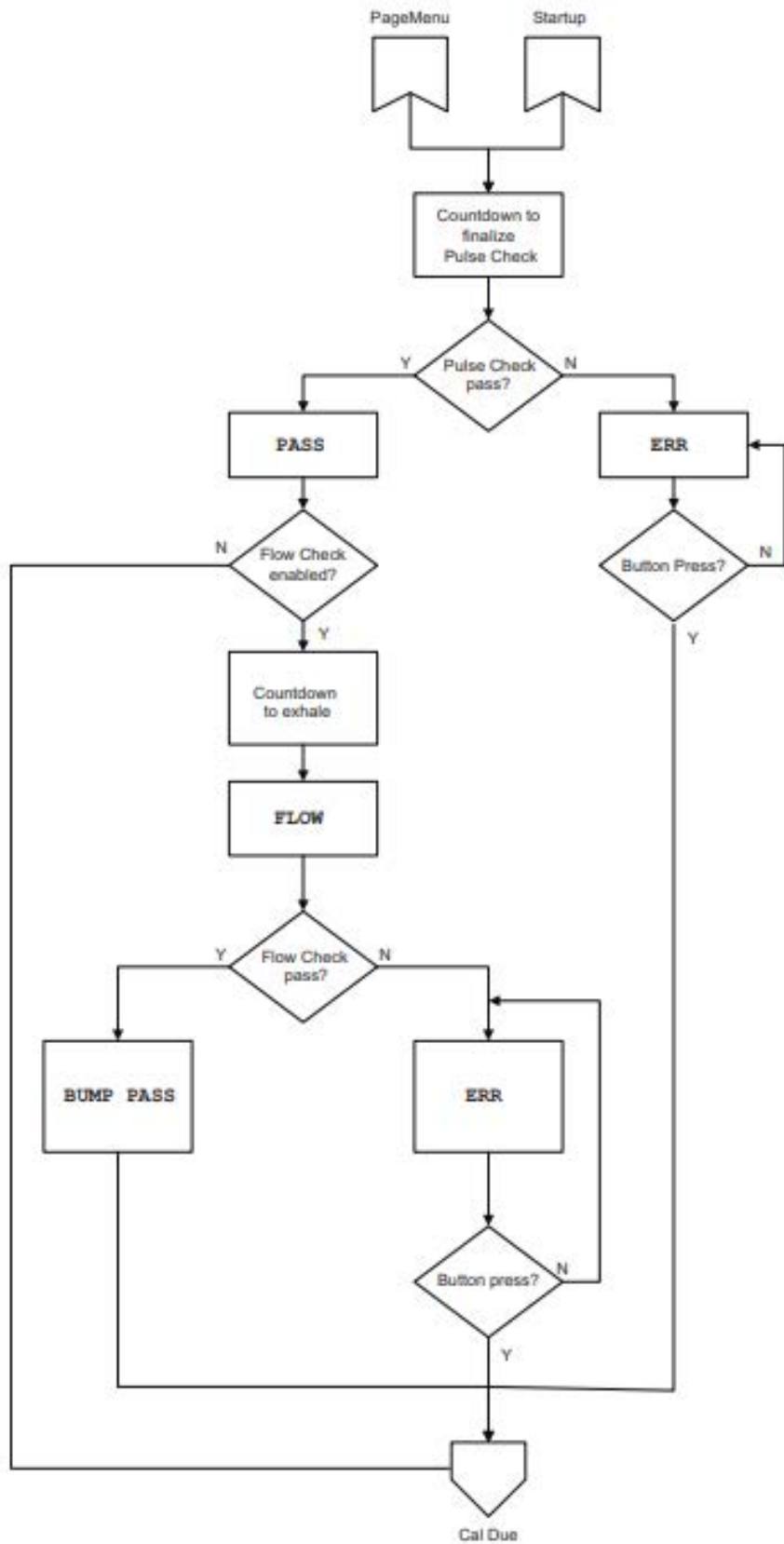

Figure 6 Bump test for devices with XCell Pulse technology

5. If Calibration Due (CAL DUE) is enabled via MSA Link™ software (default is OFF):

- If calibration is due, CAL DUE will scroll across the display continuously. Press the button to proceed. A calibration is now necessary.
- If calibration is not due, CAL, the number of days, and DAYS will scroll across the display once before proceeding.

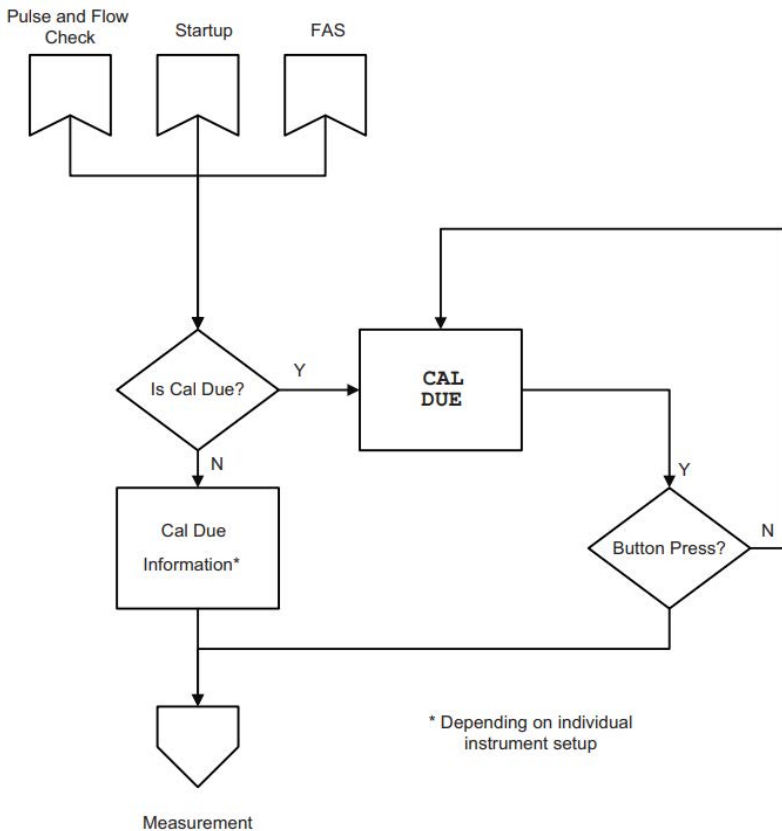

Figure 7 Calibration due

The device displays the gas reading in ppm or mg/m<sup>3</sup> and the battery condition.

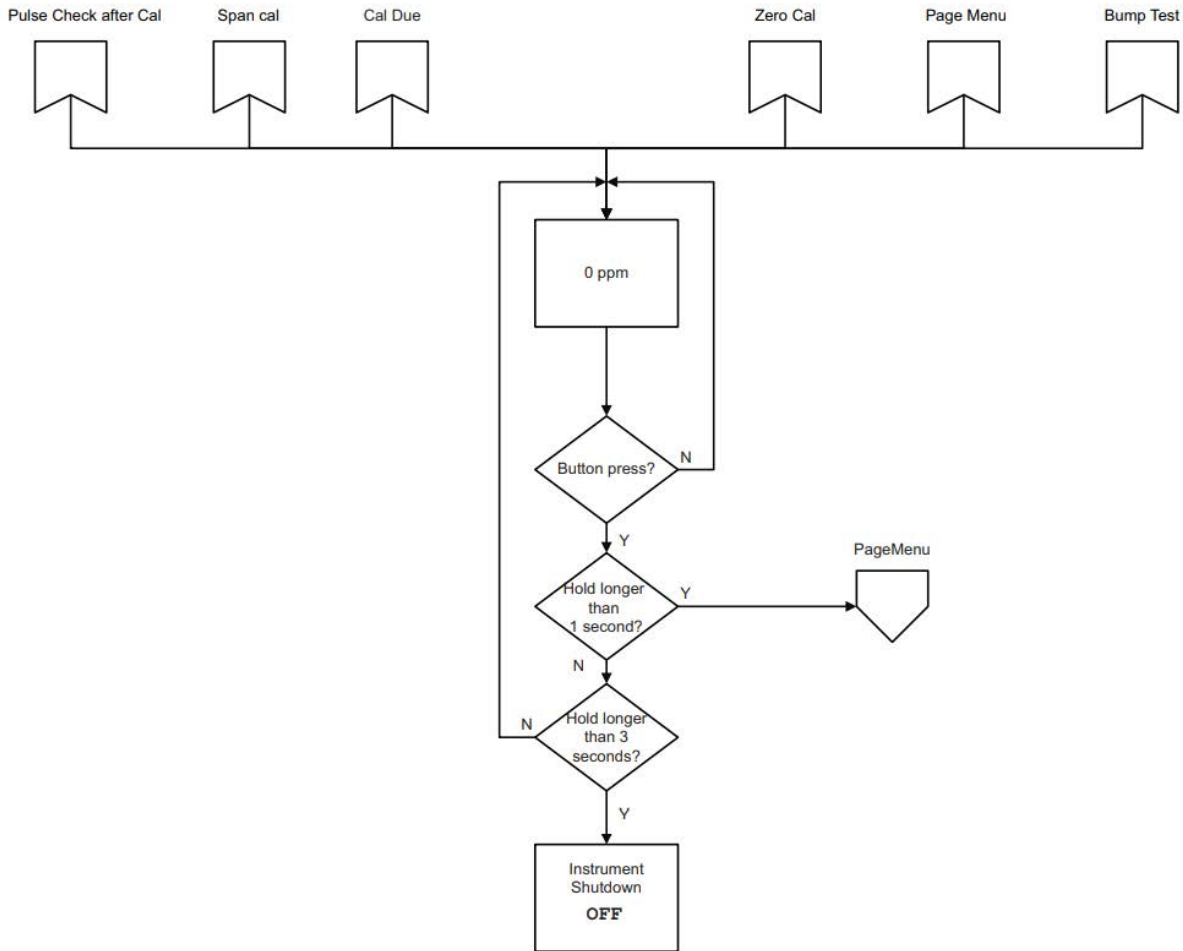

Figure 8 Measurement

### 3.5 Function Checks Before Use

#### Checking the Confidence Indicator

The Confidence indicator must flash every 15 seconds after starting the device. This indicates the device is operating correctly.

#### Verifying Alarms

Verify that the audible, visual and vibrating alarms function.

During the turn-on sequence, the alarms are briefly activated (function tests). See section 3.2 for details.

## Bump Test

### WARNING!

Perform a bump test to verify proper device operation. Failure to perform this test can result in serious personal injury or death.

Bump test frequency is often stipulated by national or corporate regulations; however, bump testing before each day's use is generally the accepted best safety practice and is therefore MSA's recommendation.

**Failure to follow this warning can result in serious personal injury or death.**

---

This test quickly confirms that the gas sensors are functioning. Perform a full calibration periodically to ensure accuracy and immediately if the device fails the bump test. The bump test can be performed using the procedure below or automatically using the GALAXY GX2 test stand.

### Bump Test for Devices without XCell Pulse Technology

1. Press the button for about 1 sec.

*BUMP?* is displayed.

2. Press the button again while *BUMP?* is displayed.

3. Feed test gas into the device:

*Connect the regulator (screwed on the calibration gas cylinder) and the sensor opening with a tube and open the regulator.*

*Possible test gases → Section 7.*

*If gas is detected PASS is displayed.*

4. Close the regulator.

If the bump test passes:

- A ✓ is displayed for 24 hours to indicate that the bump test was successful.
- If the safe LED (green) option is enabled, the green LEDs will flash every 15 seconds.

If the ✓ does not appear and *ERR* is displayed, check:

- whether the sensor cover is clogged or filter is dirty,
  - whether the correct test gas and regulator were used,
  - whether the test gas cylinder is empty or the date has expired,
  - whether the test gas was fed in at the right moment,
  - whether test gas hose and cylinder/regulator as well as sensor cover and sensor are properly connected,
  - whether the flow regulator is set to 0.25 l/min
5. Repeat the bump test if necessary.
  6. If the bump test fails, calibrate the device (→ Section 3.13).
  7. Repeat the bump test after the calibration.

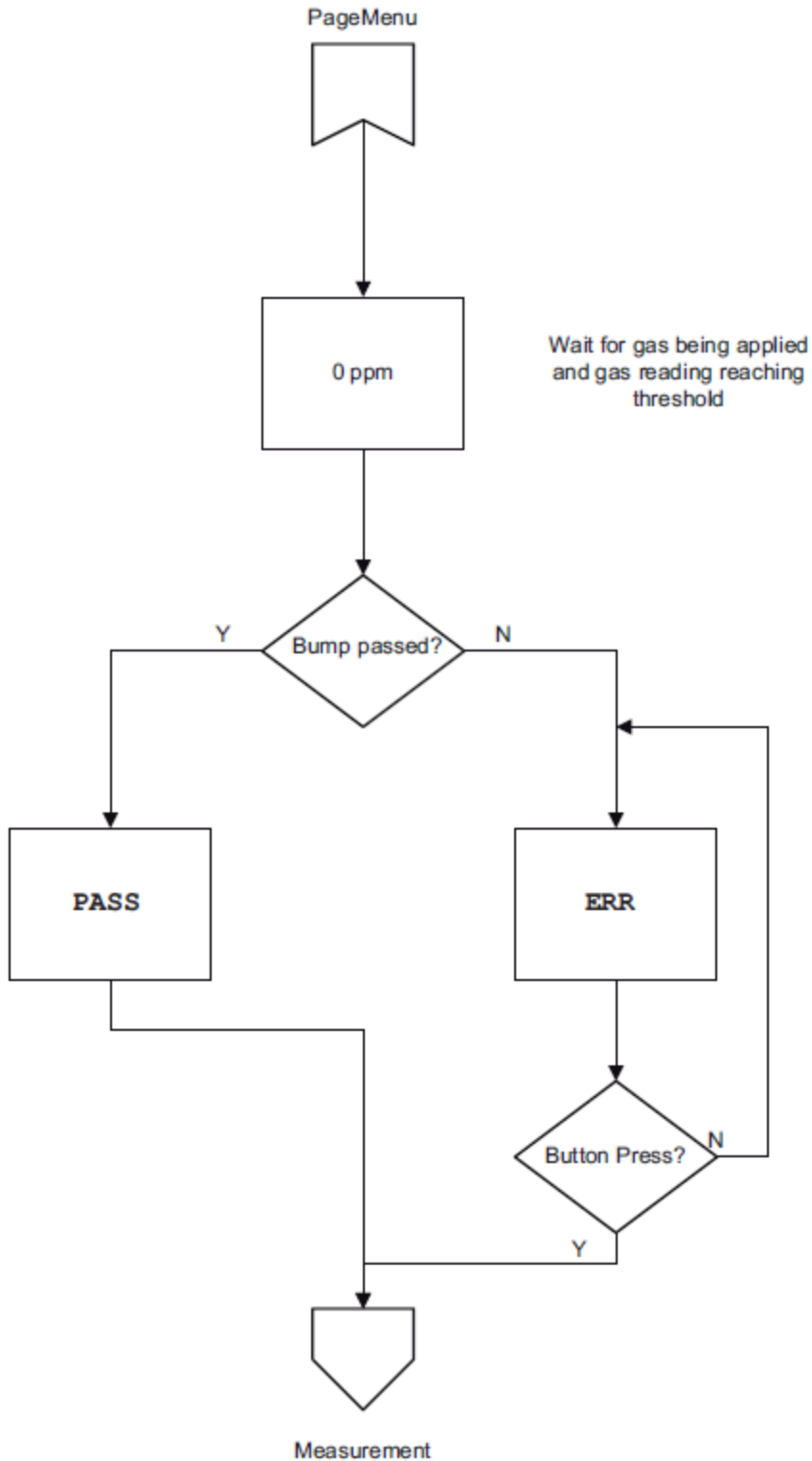

Figure 9 Bump Test for devices without XCell Pulse technology

### Bump Test for Devices with XCell Pulse Technology

Devices with XCell Pulse technology can be bump tested with a combination of a pulse check and a flow check.



1. Press the button for about 1 second.

*PULSE?* is displayed.

2. Press the button again while *PULSE?* is displayed.
3. Follow the instructions in section 3.4

### 3.6 Duration of Use

#### Normal Operation

The device is ready for operation

- as long as the empty battery icon is not flashing empty **and**
- the function tests are successful.

#### **WARNING!**

If an alarm is triggered while using the device as a monitor, leave the area immediately.

Remaining on site under such circumstances can cause serious personal injury or death.

**Failure to follow this warning can result in serious personal injury or death.**

---

#### Battery Life Indicator

The battery condition icon is continuously displayed in the upper right-hand corner of the display. As the battery is depleted, battery icon segments blank until only the battery icon outline remains.

#### Battery Warning

A battery warning indicates that a nominal two days of operation remain at 20 °C before the device's battery is depleted. Actual runtime will vary depending on ambient temperature and alarm conditions.



The duration of remaining device operation during battery warning depends on ambient temperature (colder temperatures may reduce battery life) and the number and duration of alarms during battery warning.

---

When the device goes into Low Battery Warning, the:

- battery life indicator flashes
- alarm sounds every 30 seconds
- alarm LEDs flash every 30 seconds
- device repeats this warning every 30 seconds and continues to operate until it is turned off or battery shutdown occurs.

#### Battery Shut Down

#### **WARNING!**

If a Battery Shutdown condition occurs, stop using the device and leave the area immediately. The device can no longer indicate potential hazards because it does not have enough power to operate properly.

**Failure to follow this warning can result in serious personal injury or death.**

---

When the battery can no longer operate the device, the device goes into Battery Shutdown mode:

- battery outline indicator flashes
- alarm icon turns ON
- alarm sounds
- alarm LEDs flash
- no gas reading display
- display alternates between BATT and ERR
- no other device pages can be viewed

The device remains in this state until it is turned OFF or the battery is completely depleted. The alarm lights and the audible alarm can be silenced by pushing the button.



When the device battery is running low, remove it from service and replace the battery.



The alarm can be turned off by pressing the button.

### 3.7 Monitoring Gas Concentration

#### **WARNING!**

If a gas alarm condition is reached while using the device as a personal or area monitor, leave the area immediately: the ambient condition has reached a preset alarm level.

**Failure to follow this warning can result in serious personal injury or death.**

#### Toxic Gases

The device displays the gas concentration in parts per million (ppm) or mg/m<sup>3</sup> on the measuring page. The device remains on this page until another page is selected or the device is turned OFF.

There are four alarm setpoints in the device:



High Alarm



Low Alarm



STEL Alarm



TWA Alarm

#### Alarm Condition

The backlight turns ON for a user-settable time during an alarm condition.

If the gas concentration reaches or exceeds the alarm setpoint:

- the alarm symbol will display and flash
- the icon for the type of alarm will display and flash
- a vibrating alarm is triggered
- an alarm sounds
- alarm LEDs flash

### Low Alarm

If the gas concentration reaches or exceeds the low alarm setpoint the device will:

- display the low alarm icon with the gas reading
- enter a low alarm sequence

The low alarm can be silenced for a few seconds by pressing the button. It automatically clears once the gas level falls below the setpoint.

### High Alarm

If the gas concentration reaches or exceeds the high alarm setpoint the device will:

- display the high alarm icon with the gas reading
- enter a high alarm sequence

The high alarm can be silenced for a few seconds by pressing the button while it is still in high alarm. The high alarm is latching and will not reset when gas concentration falls below the HIGH setpoint.



To reset the alarm, push the button after the gas level falls below the setpoint.

---

Refer to the device during turn ON for factory-set alarm points.

### STEL Alarm

When the amount of gas detected by the device is greater than the STEL limit:

- Alarm sounds
- Alarm LEDs flash
- STEL icon is displayed

The STEL alarm can be silenced for a few seconds by pressing the button while it is still in alarm.

The STEL alarm is non-latching and will reset when STEL reading falls below the STEL setpoint. The STEL value can be cleared. (→ [Figure 10](#) for details.)

### TWA Alarm

When the TWA reading reaches or exceeds the TWA alarm setpoint:

- Alarm sounds
- Alarm LEDs flash
- TWA icon is displayed.

The TWA alarm can be silenced for a few seconds by pressing the button while it is still in alarm.

The TWA alarm is latching and will not reset. The TWA value can be cleared. (→ [Figure 10](#) for details.)

Refer to the device during test mode for factory-set alarm setpoints.

### 3.8 Changing Alarm Setpoints

Alarm setpoints can only be changed using the MSA Link™ Software.

### 3.9 Displaying Device Data

The Information page can be accessed by pushing the button for over one second.

The following modes are displayed:

<b>Bump test</b>	
<b>Peak Reading</b>	<p>The Peak/Hi and Min/Low values can be cleared.</p> <p>When this page is displayed, press the button to clear.</p> <ul style="list-style-type: none"> <li>• CLR is displayed</li> <li>• Value is deleted</li> </ul>
<b>Short Term Exposure Limit</b>	<p>The STEL reading calculated since power-ON displays. When this page is displayed, press the button to clear.</p> <ul style="list-style-type: none"> <li>• CLR is displayed</li> <li>• Value is deleted</li> </ul> <p>STL value is automatically reset to zero when the device is turned ON.</p>
<b>Time Weighted Average</b>	<p>The TWA reading calculated since power-ON displays. When this page is displayed, press the button to clear.</p> <ul style="list-style-type: none"> <li>• CLR is displayed</li> <li>• Value is deleted</li> </ul> <p>TWA value is automatically reset to zero when the device is turned ON.</p>

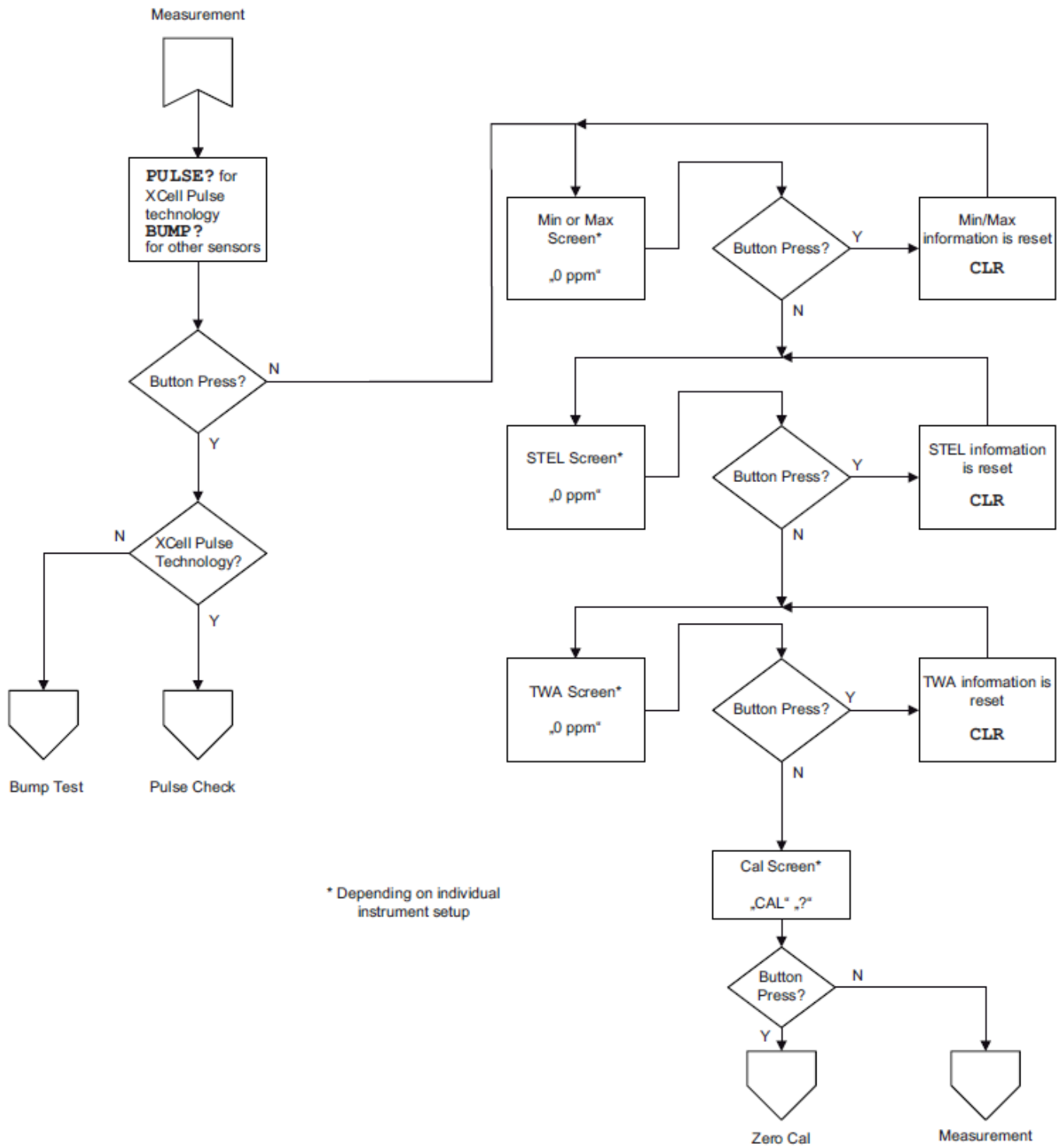

Figure 10 Displaying device data

### 3.10 IR mode

A button press in measurement mode will activate IR mode for 1 minute. If no IR communications are detected, the device will exit this mode automatically.

### 3.11 Turning OFF the Device

1. Press and hold button until OFF is displayed.
2. Release button while OFF is being displayed to turn off the device.

### 3.12 Data Logging

#### Session Data Log

The device can record events (see section 5.3 for details).

#### Periodic Data Log

Peak gas readings are periodically logged, based on user settings (see section 5.3 for details).



The date and time display are based on the PC time. Make sure that the date and time on the PC are correct.

Changing the device battery can result in lost time in the data log.

After changing batteries, verify the Time and Date with the PC.

---

### Connecting Device and a PC

1. Switch on PC and align device to the IR interface of the PC.
2. Press the button on the device to enter IR mode.
3. Start the MSA Link™ Software on the PC and start the connection.

### 3.13 Calibration

The device must be calibrated if it does not pass a bump test.

Perform a bump test (see section 3.5) before each day's use to verify proper device operation. The device must pass the bump test. If it fails the test, perform a calibration before using the device.

A calibration consists of the adjustment of the sensor output to match the precise concentration value of a known, traceable, calibration gas cylinder. A calibration can be performed at any time to ensure maximum accuracy. Calibration frequency is often stipulated by national or corporate regulations; however, a calibration should be performed periodically at regular intervals or if the unit fails a bump test. MSA recommends a calibration interval of 2 months for devices with XCell Pulse technology and a maximum 6 months for devices with standard XCell sensors.

Make sure that the calibration is carried out in clean, non-contaminated ambient air.

#### **WARNING!**

Regulators and tubing used for bump testing and calibrating Cl<sub>2</sub> or NH<sub>3</sub> must be labelled by the user for that specific gas and must only be used for that gas exclusively in the future.

**Failure to follow this warning can result in serious personal injury or death.**

---



Due to high reactivity of Cl<sub>2</sub> and NH<sub>3</sub> gas, ambient humidity and calibration tubing material can react with the gas and cause the concentration reading to be lower than the actual concentration. When calibrating or bump checking with these gases, use dry tubing (for adequate material see section 7). For best calibration, use the shortest possible tubing to connect to the calibration cylinder for this gas.

---

Devices must be calibrated:

- after subjected to physical shock,
- after any extreme changes in the atmospheric temperature,
- after use under high gas concentrations,
- if the bump test/FAS failed,
- at certain intervals by local procedures.

Calibration mode can be entered after the info screens have been displayed (see [Figure 10](#)).

1. Press button for one second to access the information page.
2. When ZERO? is displayed, press the button for a zero calibration.



If no zero calibration is carried out, the device returns to normal operating mode.

- 
- During the setup, the hour glass, the no calibration gas icon and the measured gas concentration are displayed.
  - If the zero cal operation fails, ERR is displayed. The device returns to normal operation after a button press.
  - If the zero calibration is successful, PASS is displayed followed by SPAN?.
3. During the SPAN? display, press the button to start the calibration mode.
  4. Feed test gas into the device:

*Connect the regulator (screwed on the calibration gas cylinder) and the sensor opening with a tube and open the regulator.*

*Possible test gases → Section 7.*

#### **WARNING!**

The concentration of the test gas used must match the stipulated in [Section 5.2](#) to calibrate the sensor correctly.

For two gas detectors, only calibration gas mixes can be used to calibrate the sensor correctly.

An incorrect calibration can lead to serious personal injury or death.

**Failure to follow this warning can result in serious personal injury or death.**

---

- The current gas reading, hour glass and calibration gas cylinder icon are displayed.
  - If calibration is successful PASS is displayed and the device returns to normal operating mode.
5. Close the regulator.
  - For devices with XCell Pulse technology, WAIT is displayed together with the “no gas cylinder” icon. This shows that the regulator must be closed and the calibration gas must be removed from the device. Once gas is removed, the device will perform a secondary calibration operation (pulse check) on the sensor. During the pulse check, a countdown is displayed. The device will then return to normal operating mode.
  - If the span calibration fails, ERR is displayed. The device returns to normal operation after a button press.
6. If calibration fails, check:

*whether the sensor inlet or sensor surface is dirty,*

*whether the correct test gas was used,*

*whether the test gas cylinder is empty or the date has expired,*

*whether the test gas hose was connected to the sensor,*

*whether the flow regulator is set to 0.25 l/min.*

7. If necessary, repeat steps (1) to (6).

*PASS is displayed. Otherwise (ERR), the device must be taken out of use.*

If the calibration is successful, a  $\checkmark$  is displayed for 24 hours. If the safe LED (green) option is enabled, the green LEDs will flash periodically.



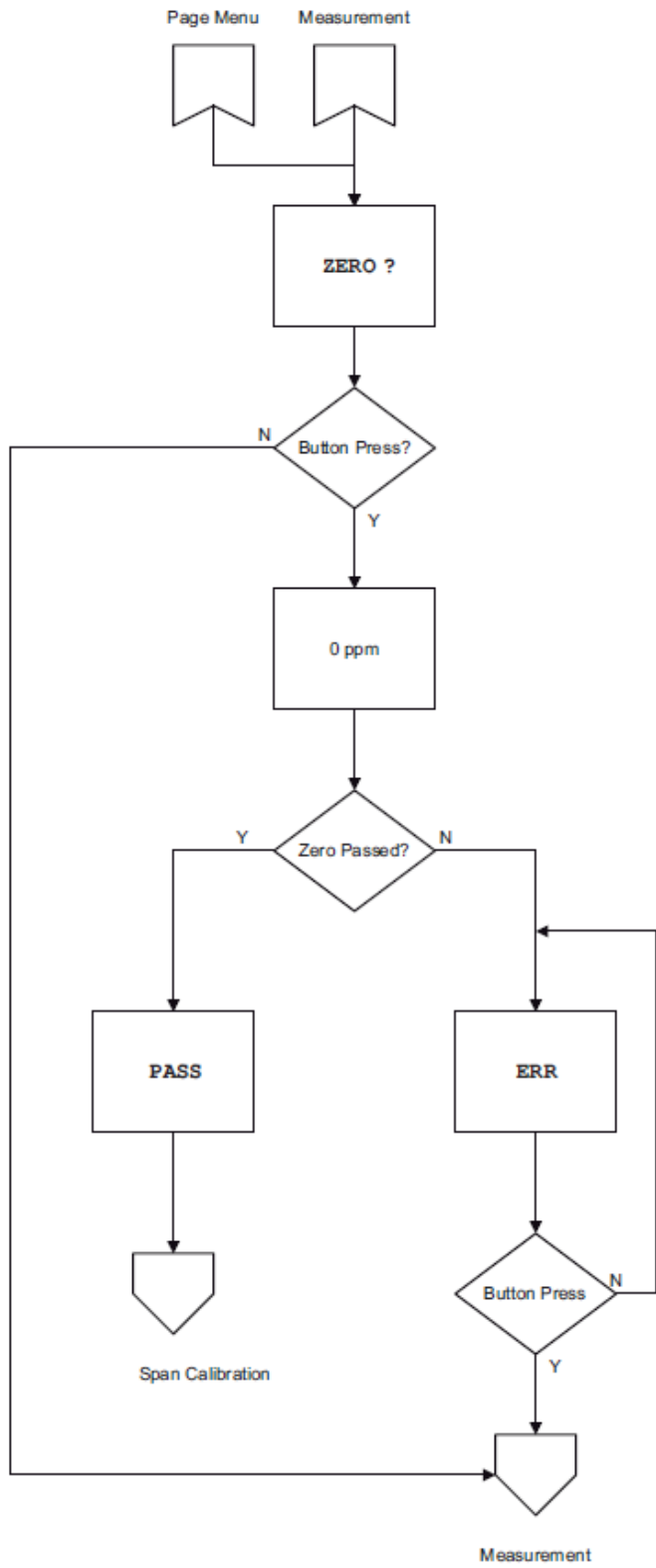

Figure 11 Zero calibration

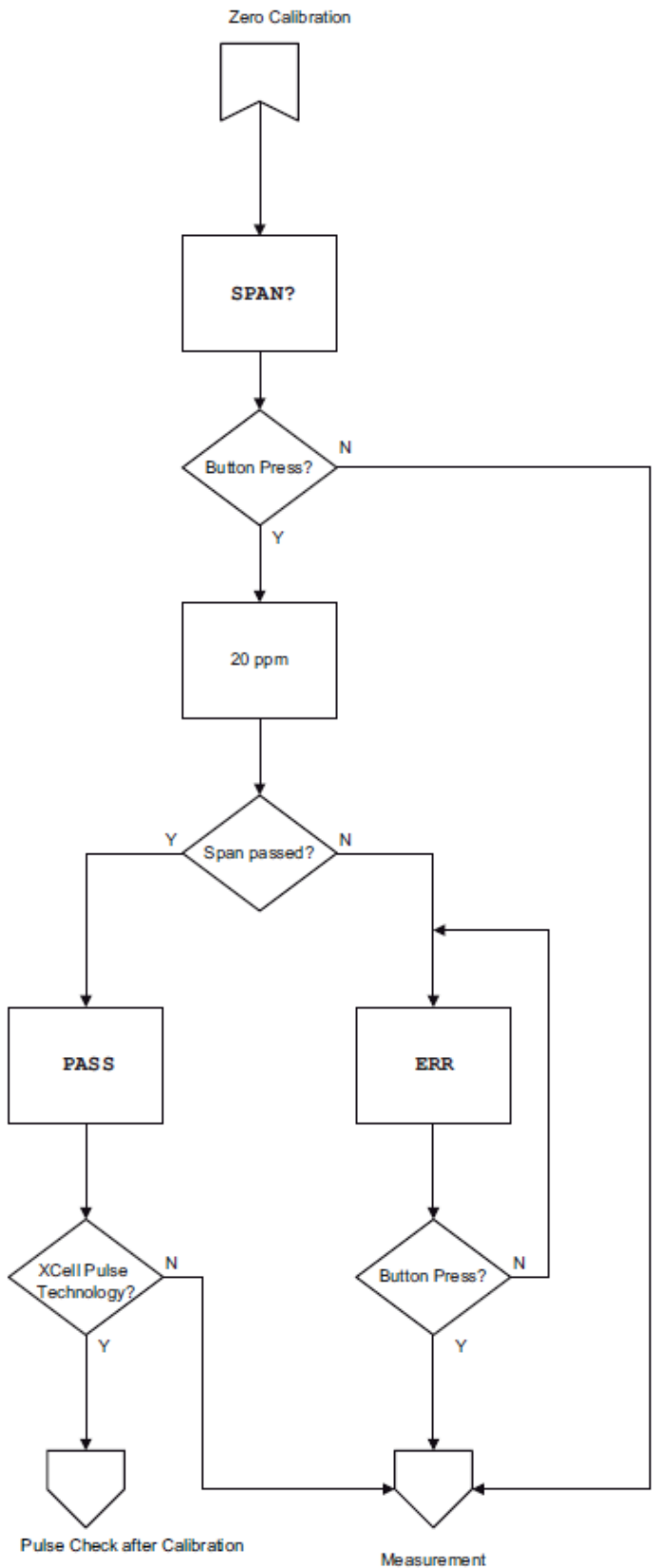

Figure 12 Span calibration

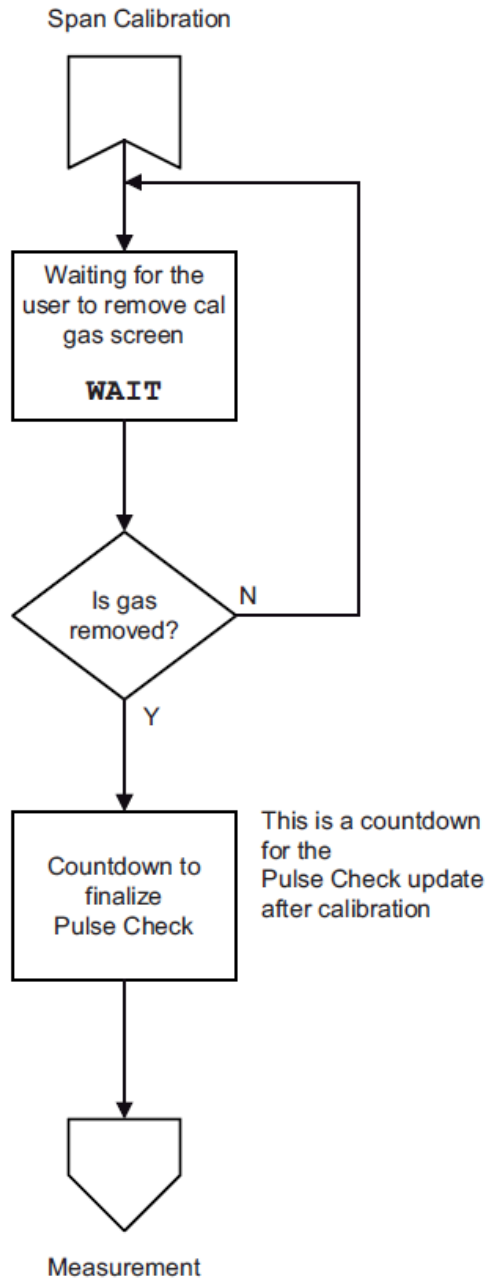

Figure 13 Pulse check after calibration for devices with XCell Pulse technology

### 3.14 Using the Device with a GALAXY GX2 Automated Test System

1. Press the button on the device to enter IR mode.

*The device pages begin to display.*

2. Place the device into the suitable GALAXY GX2 test stand.

For further information see the operating manual for the GALAXY GX2 Automated Test System.





## 4 Maintenance

If an error occurs during operation, use the displayed error codes to determine appropriate next steps.



Refer to EN 45544-4 (Guide for the selection, installation, use and maintenance of electrical apparatus used for the direct detection and direct concentration measurement of toxic gases and vapors).

### 4.1 Troubleshooting

Problem	Description	Reaction
<b>Display</b>		
MEM RST	Data Error	Calibrate device. Reconfigure any custom settings (alarm setpoints, data log, etc...)
PCB ERR #	Electronic component error	Contact MSA *)
PRG ERR #	Program memory error	Contact MSA *)
RAM ERR #	RAM error	Contact MSA *)
UNK ERR #	Unknown error	Contact MSA *)
SNS ERR #	Sensor error	Contact MSA *)
	Sensor warning	Sensor is near the end of its life
	Sensor alarm	Sensor has reached the end of its life and cannot be calibrated. Replace sensor and recalibrate.
	Battery warning (no alarm)	Remove from service as soon as possible and replace battery
 BATT ERR	Battery empty (with alarm – flash LEDs, horn)	Device is no longer sensing gas. Remove from service and replace battery.
Device does not turn ON	Low battery	Replace battery

\*) If the error occurs during the warranty period, please contact the MSA customer service. Otherwise, the device must be put out of operation.

#: Some errors will show an additional error code number which should be noted and be available when contacting MSA.

### 4.2 Replacing the Battery

#### **⚠ WARNING!**

Risk of explosion: Do not change batteries in hazardous areas.

**Failure to follow this warning can result in serious personal injury or death.**

Only replace with battery as listed in section 7 .

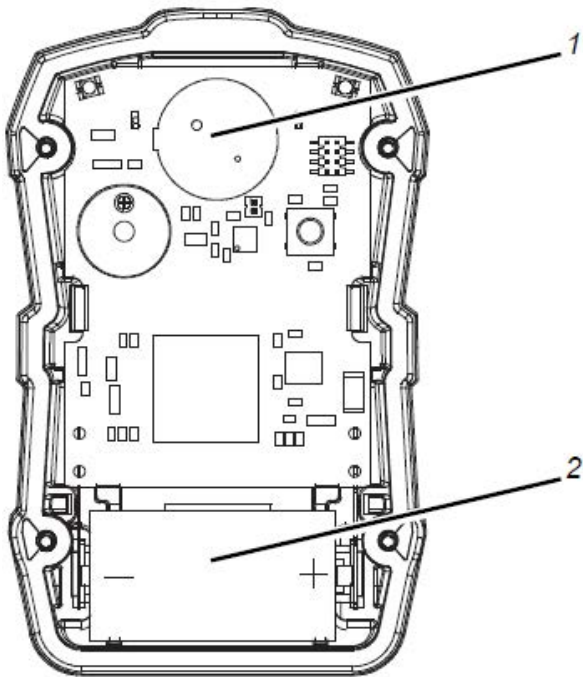

Figure 14 Sensor and Battery Replacement

- 1 Sensor
- 2 Battery

1. Remove the four screws securing the case halves together.
2. Carefully remove the front case to expose the battery.

*The circuit board will remain with the back half of the case.*

*Do not touch the display connections (two blue connectors).*

3. Remove the depleted battery and replace only with one specified in section 7 .

*Be sure to observe proper polarity on the battery, as shown on the battery holder.*

4. Ensure the interface and connectors for the display are clean and free of dirt for proper operation.

*If necessary, the display connectors can be cleaned with a soft, lint free cloth.*

5. Reinstall the front case, making sure the sensor, horn gasket and sensor gasket are properly seated.

**⚠ CAUTION!**

Do not over-tighten the screws; otherwise, the case may be damaged.

**Failure to follow this caution can result in minor or moderate injury.**

---

6. Replace the four screws, tighten with a torque value of 2.5 in-lbs (0.28 Nm).

**⚠ CAUTION!**

After replacing the battery or if the device was without power for some time, it is necessary to set time and date again using the MSA Link software.

**Failure to follow this caution can result in minor or moderate injury.**

---

When switching ON the device for the first time and after a battery replacement the device will initialize the battery. During a battery initialization, `BATT TEST` is shown on the display followed by a sequence of LED illuminations and activation of the vibration motor. The device then continues the start-up as described in section 3.4.

**NOTE:** It may take 24 hours for the battery condition icon to indicate the full battery charge level after the battery initialisation.

### 4.3 Replacing the Sensor

**⚠ CAUTION!**

Before handling the PC board, ensure you are properly grounded; otherwise, static charges from your body could damage the electronics. Such damage is not covered by the warranty. Grounding straps and kits are available from electronics suppliers.

**Failure to follow this caution can result in minor or moderate injury.**

---

1. Verify that the device is turned off.
2. Remove the four case screws and remove the front case to expose the sensor (located near the top of the device, near the alarm lights → [Figure 14](#)).
3. Gently lift out and properly discard the sensor.

**⚠ WARNING!**

The new replacement sensor must be the same part number and type as the one being replaced; otherwise, improper operation will result.

**Failure to follow this warning can result in serious personal injury or death.**

---

4. Install the new sensor in the sockets on the PC board (it can only be installed one way). Press the sensor firmly in place against the board.
5. Reinstall the front case, making sure the sensor, horn gasket, and sensor gasket are properly seated.
6. Ensure the interface and connectors for the display are clean and free of dirt for proper operation.

If necessary, the display connectors can be cleaned with a soft, lint-free cloth.

### CAUTION!

Do not over-tighten the screws; otherwise, the case may be damaged.

**Failure to follow this caution can result in minor or moderate injury.**

---

7. Reinstall the screws, tighten with a torque value of 2.5 in-lbs (0.28 Nm).

### WARNING!

Calibration is required after a sensor is installed; otherwise, the device will not perform as expected and persons relying on this product for their safety could sustain serious personal injury or death.

**Failure to follow this warning can result in serious personal injury or death.**

---

8. Calibrate the device.

#### 4.4 Cleaning

Clean the exterior of the device regularly using only a damp cloth. Do not use cleaning agents other than listed in section 7.

#### 4.5 Storage

When not in use, store the device in a safe, dry place between 0 °C and 40 °C. After storage, always recheck device calibration before use.

#### 4.6 Scope of Delivery

Pack the device in its original shipping container with suitable padding. If the original container is unavailable, an equivalent container may be substituted.

## 5 Technical Data

### 5.1 Technical Specifications

<b>Weight</b>	115 g (4 oz) (device with battery and clip)		
<b>Dimensions(L x W x D)</b>	87 x 55 x 48 mm (3.4 x 2.2 x 1.9 in) – with fastening clip		
<b>Alarms</b>	Two super bright LEDs with 320° viewing angle and a loud audible alarm, vibrating alarm		
<b>Volume of audible alarm</b>	95 dB typical at 30 cm distance		
<b>Displays</b>	Large display of measured values		
<b>Battery type</b>	Non-rechargeable Lithium battery. Only replace with: battery as listed in section 7 .		
<b>Battery life</b>	6 months to 18 months, depending on device settings, environmental conditions and general care and use. At very low and very high temperatures the useable battery runtime can be significantly reduced.		
<b>Sensor</b>	Electrochemical		
<b>Warm up time</b>	1 minute during start-up procedure		
<b>Temperature range</b>	Normal Operating Range	-10°C to 40°C	(14°F to 104°F)
	Extended Operating Range	-20°C to 50°C	(-4°F to 122°F)
	Short-term exposure (excluding the CO-HC sensor)	-40°C to 60°C	(-40°F to 140°F)
	Storage		(32°F to 104°F)
	Vibrating Alarm		(32°F to 122°F)
	Intrinsic Safety (ATEX, IEC, CSA)	-40°C to 60°C	(-40°F to 140°F)
	At extremely low temperatures (below -20°C), the display can have a very slow update rate and can become hard to read.		
<b>Atmospheric Pressure Range</b>	80 to 120 kPa	(11.6 to 17.4 PSIA)	
<b>Humidity range</b>	15 % to 90 % relative humidity, non-condensing		
	5 % to 95 % relative humidity intermittent		
<b>Dust and spray protection</b>	IP 67		

### 5.2 Sensor Data

#### Factory-set Alarm Thresholds and Setpoints

Sensor	Low Alarm Set Point	High Alarm - Setpoint	Minimum Alarm -Setpoint	Maximum Alarm -Setpoint	STEL	TWA
CO Carbon Monoxide	25 ppm	100 ppm	10 ppm	1700 ppm	100 ppm	25 ppm



## 5 Technical Data

Sensor	Low Alarm Set Point	High Alarm - Setpoint	Minimum Alarm -Setpoint	Maximum Alarm -Setpoint	STEL	TWA
CO Carbon Monoxide High Concentration	25 ppm	100 ppm	10 ppm	8500 ppm	100 ppm	25 ppm
H <sub>2</sub> S Hydrogen Sulfide	10 ppm	15 ppm	5 ppm	175 ppm	15 ppm	10 ppm
H <sub>2</sub> S Low Concentration (CO/H <sub>2</sub> S-LC sensor)	5.0 ppm	10.0 ppm	1.0 ppm	70.0 ppm	10.0 ppm	1.0 ppm
H <sub>2</sub> S Low Concentration (H <sub>2</sub> S-LC/SO <sub>2</sub> sensor)	10.0 ppm	15.0 ppm	1.0 ppm	70.0 ppm	15.0 ppm	10.0 ppm
Cl <sub>2</sub> Chlorine	0.5 ppm	1.0 ppm	0.3 ppm	7.5 ppm	1.0 ppm	0.5 ppm
NH <sub>3</sub> Ammonia	25 ppm	50 ppm	10 ppm	75 ppm	35 ppm	25 ppm
NO <sub>2</sub> Nitrogen Dioxide	2.5 ppm	5.0 ppm	1.0 ppm	47.5 ppm	5.0 ppm	2.5 ppm
SO <sub>2</sub> Sulphur Dioxide	2.0 ppm	5.0 ppm	1.0 ppm	17.5 ppm	5.0 ppm	2.0 ppm

### Performance Specifications

Sensor	Range	Resolution	Reproducibility	
			Normal -Temperature Range	Extended -Temperature Range
CO Carbon -Monoxide	0-1999 ppm	1 ppm	+/-5 ppm or 10% of reading, whichever is greater	+/-10 ppm or 20% of reading, whichever is greater
CO Carbon -Monoxide High -Concentration	0-9999 ppm	5 ppm	+/-10 ppm or 10% of reading, whichever is greater	+/-25 ppm or 20% of reading, whichever is greater
H <sub>2</sub> S Hydrogen Sulfide	0-200 ppm	1 ppm	+/-2 ppm or 10% of reading, whichever is greater	+/-5 ppm or 20% of reading, whichever is greater
H <sub>2</sub> S Low Concentration (CO/H <sub>2</sub> S-LC -sensor)	0-100.0 ppm	0.1 ppm	+/-2 ppm or 10% of reading, whichever is greater	+/-5 ppm or 20% of reading, whichever is greater
H <sub>2</sub> S Low Concentration (H <sub>2</sub> S-LC/SO <sub>2</sub> -sensor)	0-100.0 ppm	0.1 ppm	+/-2 ppm or 10% of reading, whichever is greater	+/-5 ppm or 20% of reading, whichever is greater
Cl <sub>2</sub> Chlorine	0-10.0 ppm	0.05 ppm	+/-0,2 ppm or 10% of reading, whichever is greater	+/-0,5 ppm or 20% of reading, whichever is greater
NH <sub>3</sub> Ammonia	0-100 ppm	1 ppm	+/-2 ppm or 10% of reading, whichever is greater	+/-5 ppm or 20% of reading, whichever is greater
NO <sub>2</sub> Nitrogen -Dioxide	0-50.0 ppm	0.1 ppm	+/-2 ppm or 10% of reading, whichever is greater	+/-3 ppm or 20% of reading, whichever is greater
SO <sub>2</sub> Sulphur -Dioxide	0-20.0	0.1 ppm	+/-2 ppm or 10% of reading,	+/-3 ppm or 20% of reading,

Sensor	Range	Resolution	Reproducibility	
			Normal -Temperature Range	Extended -Temperature Range
	ppm		whichever is greater	whichever is greater

### Calibration Specifications

Sensor	Response Time (- Typical) t[90]	Zero Gas	Zero Cal Value	Calibration Gas Concentration	Span Cal Time [min]
CO Carbon Monoxide	<15 s	Fresh Air	0 ppm	60 ppm	1
H <sub>2</sub> S Hydrogen Sulfide	<15 s	Fresh Air	0 ppm	20 ppm	1
Cl <sub>2</sub> Chlorine	<30 s	Fresh Air	0 ppm	10 ppm	2
NH <sub>3</sub> Ammonia	<40 s	Fresh Air	0 ppm	25 ppm	2
NO <sub>2</sub> Nitrogen Dioxide	<15 s	Fresh Air	0 ppm	10 ppm	2
SO <sub>2</sub> Sulphur - Dioxide	<15 s	Fresh Air	0 ppm	10 ppm	1



### 5.3 Data Logging Specifications

<b>Session data log</b>	<b>Number of stored events</b>	Greater than 300 (most recent occurrences)	
	<b>Data transmission method</b>	Via MSA infrared adapter on a PC using MSA <sup>®</sup> Link™ software	
	<b>Event log information</b>		Alarm - Alarm Type - Alarm Value - Time/Date
			Alarm Clear - Alarm Type - Alarm Value - Time/Date
			Cal (Pass/Fail) - Time/Date
			Bump (Pass/Fail) - Time/Date
			Error Non-Shutdown - Error Type (See Error List) - Time/Date
		ON/OFF - Time/Date	
	Alarm Peak (during an alarm event) - Alarm Value - Time/Date		
	<b>Transmission time</b>	Typically less than 60 seconds max.	
<b>Periodic data log</b>	<b>Default logging interval</b>	Three minute peak readings (configurable via PC from 15 seconds to 15 minute peaks or one minute average)	
	<b>Storage time</b>	Typically greater than 850 hours for two-gas devices and greater than 950 hours with	

	<b>estimate</b>	single gas devices with default interval (storage time varies based on interval and sensor activity)
	<b>Transmission time</b>	Dependent on number of records.

## 6 Certification

See device label for the certification that applies to the specific device.

Country	USA	
		<p><b>Exia</b></p> <p>Class I, Groups A, B, C, D</p> <p>Class II, Groups E, F, G</p> <p>Class III</p> <p>Ambient temperature: -40 °C to +60 °C; T4</p>
	<b>Canada</b>	
		<p><b>Exia</b></p> <p>Class I, Groups A, B, C, D</p> <p>Class II, Groups E, F, G</p> <p>Class III</p> <p>Ambient temperature: -40 °C to +60 °C; T4</p>

### 6.1 Marking, Certificates and Approvals According to the Directive 2014/34/EU (ATEX)

Manufacturer:	MSA The Safety Company 1000 Cranberry Woods Drive Cranberry Township, PA 16066 USA
Product:	
EC-Type Examination Certificate:	FTZU 13 ATEX 0200 X
Type of protection:	EN 60079-0: 2012+A11:2013, EN 60079-11: 2012
Performance:	none
Marking:	 II 1G Ex ia IIC T4 Ga -40° C ≤ Ta ≤ +60° C
Battery:	T4: Lithium Saft LS 17330 Lithium EEMB ER 17335 <ol style="list-style-type: none"><li>1. The battery shall not be replaced in hazardous area.</li><li>2. There shall only be used batteries Saft LS17330 or EEMB ER17335 i this equipment.</li><li>3. The equipment enclosure includes accessible metal parts. The end user shall determine suitability in the specific application. The measured capacitance of the equipment on the item back clip is 40pF.</li><li>4. The performance test to the equipment are not a subject of this certificate.</li></ol>
Special Conditions:	
Quality Assurance Notification:	0080
Year of Manufacture:	see Label
Serial Nr.:	see Label

## 6.2 Marking, Certificates and Approvals According to IECEx

Manufacturer:	MSA The Safety Company 1000 Cranberry Woods Drive Cranberry Township, PA 16066 USA	
Product:		
IECEx-Type Examination -Certificate:	IECEx FTZU 13.0025X	
Type of protection:	IEC 60079-0: 2017, IEC 60079-11: 2011	
Performance	none	
Marking:		Ex ia IIC T4 Ga -40° C ≤ Ta ≤ +60° C
Battery:	T4 :	Lithium Saft LS 17330 Lithium EEMB ER 17335
Special Conditions	<ol style="list-style-type: none"> <li>1. The battery shall not be replaced in hazardous area.</li> <li>2. There shall only be used batteries Saft LS17330 or EEMB ER17335 i this equipment.</li> <li>3. The equipment enclosure includes accessible metal parts. The end user shall determine suitability in the specific application. The measured capacitance of the equipment on the item back clip is 40pF.</li> <li>4. The performance test to the equipment are not a subject of this certificate.</li> </ol>	

## 7 Ordering Information

### 7.1 Calibration Gas Cylinders

Description	Part Number	
	N.A.	EU
Cylinder, 60 ppm CO, 34 L	710882	10073231
Cylinder, 60 ppm CO, 20 ppm H <sub>2</sub> S, 34 L	10153800	10154976
Cylinder, 60 ppm CO, 20 ppm H <sub>2</sub> S, 58 L	10153801	10154977
Cylinder, 60 ppm CO, 20 ppm H <sub>2</sub> S, 116 L	10153802	-
Cylinder, 60 ppm CO, 10 ppm NO <sub>2</sub> , 34 L	10153803	10154978
Cylinder, 60 ppm CO, 10 ppm NO <sub>2</sub> , 58 L	10153804	10154980
Cylinder, 60 ppm CO, 10 ppm NO <sub>2</sub> , 116 L	10153805	-
Cylinder, 20 ppm H <sub>2</sub> S, 10 ppm SO <sub>2</sub> , 34 L	10153806	10154995
Cylinder, 20 ppm H <sub>2</sub> S, 10 ppm SO <sub>2</sub> , 58 L	10153807	10154996
Cylinder, 20 ppm H <sub>2</sub> S, 10 ppm SO <sub>2</sub> , 116 L	10153808	-
Cylinder, 20 ppm H <sub>2</sub> S, 34 L	10153844	10155919
Cylinder, 20 ppm H <sub>2</sub> S, 58 L	10153845	10155918
Cylinder, 20 ppm H <sub>2</sub> S, 116 L	10153846	-
Cylinder, 10 ppm Cl <sub>2</sub> , 34 L	711066	10011939
Cylinder, 10 ppm Cl <sub>2</sub> , 58 L	806740	-
Cylinder, 10 ppm NO <sub>2</sub> , 34 L	711068	10029521
Cylinder, 10 ppm NO <sub>2</sub> , 58 L	808977	-
Cylinder, 10 ppm SO <sub>2</sub> , 34 L	711070	10079806
Cylinder, 10 ppm SO <sub>2</sub> , 58 L	808978	-
Cylinder, 25 ppm NH <sub>3</sub> , 34 L	711078	10079807
Cylinder, 25 ppm NH <sub>3</sub> , 58 L	814866	-

### 7.2 Replacement Parts and Accessories

Description	Part Number
Regulator, 0.25 lpm	467895
Regulator, 0.25 lpm, Combination	711175
Tubing, 40 cm (16") (not used for NH <sub>3</sub> , Cl <sub>2</sub> )	10030325
Tubing, 40 cm (16"), Tygon (NH <sub>3</sub> , Cl <sub>2</sub> )	10080534
Repair Kit (Suspender clip, clip screw, adhesive strip, 4 case case screws, horn/sensor gasket, battery foam)	10154518

Description	Part Number
MSA Link IR Dongle with USB connector	10082834
Horn and Sensor Gasket	10152337-SP
Battery (Pack of 8)	10155203-SP
Screws, Case (Pack of 40)	10153060-SP
Front Case Replacement Assembly with Gaskets and Display (without front label)	
<ul style="list-style-type: none"> <li>• Grey for non-reactive gases (with filter)</li> </ul>	10154519
<ul style="list-style-type: none"> <li>• Glow-in-the-dark for non-reactive gases (with filter)</li> </ul>	10154597
<ul style="list-style-type: none"> <li>• Grey for reactive gases (without filter)</li> </ul>	10154598
Front Case Label, Cl <sub>2</sub> (strip of 6)	10149015-SP
Front Case Label, CO (strip of 6)	10149011-SP
Front Case label, CO/H <sub>2</sub> S (strip of 6)	10149000-SP
Front Case label, CO/NO <sub>2</sub> (strip of 6)	10149014-SP
Front Case Label, H <sub>2</sub> S (strip of 6)	10153586-SP
Front Case label, H <sub>2</sub> S/SO <sub>2</sub> (strip of 6)	10149013-SP
Front Case Label, H <sub>2</sub> S-PLS (strip of 6)	10149012-SP
Front Case Label, NH <sub>3</sub> (strip of 6)	10149016-SP
Front Case Label, NO <sub>2</sub> (strip of 6)	10152883-SP
Front Case Label, SO <sub>2</sub> (strip of 6)	10152882-SP
Alcohol-free sanitizing wipe	10154893-SP

### 7.3 Sensor Replacement Kits

Description	Part Number
Cl <sub>2</sub> low power, replacement kit, XCell sensor	10152600
CO-HC low power, replacement kit, XCell sensor	10152602
H <sub>2</sub> S/CO low power, replacement kit, XCell sensor	10152603
H <sub>2</sub> S/CO-H <sub>2</sub> low power, replacement kit, XCell sensor	10152604
H <sub>2</sub> S-LC/CO low power, replacement kit, XCell sensor	10152605
H <sub>2</sub> S-LC/SO <sub>2</sub> low power, replacement kit, XCell sensor	10152607



## 7 Ordering Information

<b>Description</b>	<b>Part Number</b>
H <sub>2</sub> S-PLS replacement kit, XCell sensor	10121227
NH <sub>3</sub> low power, replacement kit, XCell sensor	10152601
NO <sub>2</sub> /CO low power, replacement kit, XCell sensor	10152606

