



# LABORATORY ROOM CONTROLLER MODEL LRC

---

OPERATION AND SERVICE MANUAL

P/N 6013156, REVISION E  
DECEMBER 2021



# START SEEING THE BENEFITS OF REGISTERING TODAY!

---

Thank you for your TSI instrument purchase. Occasionally, TSI releases information on software updates, product enhancements and new products. By registering your instrument, TSI will be able to send this important information to you.

**<http://register.tsi.com>**

As part of the registration process, you will be asked for your comments on TSI products and services. TSI's customer feedback program gives customers like you a way to tell us how we are doing.



UNDERSTANDING, ACCELERATED

**TSI Incorporated** - Visit our website [www.tsi.com](http://www.tsi.com) for more information.

<b>USA</b>	<b>Tel:</b> +1 800 874 2811	<b>India</b>	<b>Tel:</b> +91 80 67877200
<b>UK</b>	<b>Tel:</b> +44 149 4 459200	<b>China</b>	<b>Tel:</b> +86 10 8219 7688
<b>France</b>	<b>Tel:</b> +33 1 41 19 21 99	<b>Singapore</b>	<b>Tel:</b> +65 6595 6388
<b>Germany</b>	<b>Tel:</b> +49 241 523030		

# LABORATORY ROOM CONTROLLER MODEL LRC

---

OPERATION AND SERVICE MANUAL

P/N 6013156, REVISION E  
DECEMBER 2021

## **U.S. AND CANADA**

### Sales & Customer Service:

(800) 680-1220 / (651) 490-2860

### Fax:

(651) 490-3824

### **SHIP/MAIL TO:**

TSI Incorporated  
ATTN: Customer Service  
500°Cardigan Road  
Shoreview, MN 55126  
USA

## **OTHER COUNTRIES**

### Sales & Customer Service:

(001 651) 490-2860

### Fax:

(001 651) 490-3824

### **E-MAIL**

[customer.service@tsi.com](mailto:customer.service@tsi.com)

### **WEB SITE**

[www.tsi.com](http://www.tsi.com)

**Limitation of Warranty and Liability** (effective April 2014)

(For country-specific terms and conditions outside of the USA, please visit [www.tsi.com](http://www.tsi.com).)

Seller warrants the goods, excluding software, sold hereunder, under normal use and service as described in the operator's manual, to be free from defects in workmanship and material for **24 months**, or if less, the length of time specified in the operator's manual, from the date of shipment to the customer. This warranty period is inclusive of any statutory warranty. This limited warranty is subject to the following exclusions and exceptions:

- a. Hot-wire or hot-film sensors used with research anemometers, and certain other components when indicated in specifications, are warranted for 90 days from the date of shipment;
- b. Pumps are warranted for hours of operation as set forth in product or operator's manuals;
- c. Parts repaired or replaced as a result of repair services are warranted to be free from defects in workmanship and material, under normal use, for 90 days from the date of shipment;
- d. Seller does not provide any warranty on finished goods manufactured by others or on any fuses, batteries or other consumable materials. Only the original manufacturer's warranty applies;
- e. This warranty does not cover calibration requirements, and seller warrants only that the instrument or product is properly calibrated at the time of its manufacture. Instruments returned for calibration are not covered by this warranty;
- f. This warranty is **VOID** if the instrument is opened by anyone other than a factory authorized service center with the one exception where requirements set forth in the manual allow an operator to replace consumables or perform recommended cleaning;
- g. This warranty is **VOID** if the product has been misused, neglected, subjected to accidental or intentional damage, or is not properly installed, maintained, or cleaned according to the requirements of the manual. Unless specifically authorized in a separate writing by Seller, Seller makes no warranty with respect to, and shall have no liability in connection with, goods which are incorporated into other products or equipment, or which are modified by any person other than Seller.

The foregoing is **IN LIEU OF** all other warranties and is subject to the **LIMITATIONS** stated herein. **NO OTHER EXPRESS OR IMPLIED WARRANTY OF FITNESS FOR PARTICULAR PURPOSE OR MERCHANTABILITY IS MADE. WITH RESPECT TO SELLER'S BREACH OF THE IMPLIED WARRANTY AGAINST INFRINGEMENT, SAID WARRANTY IS LIMITED TO CLAIMS OF DIRECT INFRINGEMENT AND EXCLUDES CLAIMS OF CONTRIBUTORY OR INDUCED INFRINGEMENTS. BUYER'S EXCLUSIVE REMEDY SHALL BE THE RETURN OF THE PURCHASE PRICE DISCOUNTED FOR REASONABLE WEAR AND TEAR OR AT SELLER'S OPTION REPLACEMENT OF THE GOODS WITH NON-INFRINGEMENTS.**

TO THE EXTENT PERMITTED BY LAW, THE EXCLUSIVE REMEDY OF THE USER OR BUYER, AND THE LIMIT OF SELLER'S LIABILITY FOR ANY AND ALL LOSSES, INJURIES, OR DAMAGES CONCERNING THE GOODS (INCLUDING CLAIMS BASED ON CONTRACT, NEGLIGENCE, TORT, STRICT LIABILITY OR OTHERWISE) SHALL BE THE RETURN OF GOODS TO SELLER AND THE REFUND OF THE PURCHASE PRICE, OR, AT THE OPTION OF SELLER, THE REPAIR OR REPLACEMENT OF THE GOODS. IN THE CASE OF SOFTWARE, SELLER WILL REPAIR OR REPLACE DEFECTIVE SOFTWARE OR IF UNABLE TO DO SO, WILL REFUND THE PURCHASE PRICE OF THE SOFTWARE. IN NO EVENT SHALL SELLER BE LIABLE FOR LOST PROFITS, BUSINESS INTERRUPTION, OR ANY SPECIAL, INDIRECT, CONSEQUENTIAL OR INCIDENTAL DAMAGES. SELLER SHALL NOT BE RESPONSIBLE FOR INSTALLATION, DISMANTLING OR REINSTALLATION COSTS OR CHARGES. No Action, regardless of form, may be brought against Seller more than 12 months after a cause of action has accrued. The goods returned under warranty to Seller's factory shall be at Buyer's risk of loss, and will be returned, if at all, at Seller's risk of loss.

Buyer and all users are deemed to have accepted this LIMITATION OF WARRANTY AND LIABILITY, which contains the complete and exclusive limited warranty of Seller. This LIMITATION OF WARRANTY AND LIABILITY may not be amended, modified or its terms waived, except by writing signed by an Officer of Seller.

**Service Policy**

Knowing that inoperative or defective instruments are as detrimental to TSI as they are to our customers, our service policy is designed to give prompt attention to any problems. If any malfunction is discovered, please contact your nearest sales office or representative, or call TSI's Customer Service department at (800) 680-1220 or (651) 490-2860.

**Trademarks**

TSI, TSI logo, VelociCalc, Alnor, and Balometer are registered trademarks of TSI Incorporated in the United States and may be protected under other country's trademark registrations. PresSura is a trademark of TSI Incorporated. BACnet is a registered trademark of ASHRAE. DISTECH is a registered trademark of DISTECH Systems Inc. ENVYSION is a registered trademark of Envysion, Inc. Google Chrome is a trademark of Google, Inc. IBM is a registered trademark of International Business Machines Corporation, Microsoft and Windows are registered trademarks of Microsoft Corporation. Apple and Bonjour are trademarks of Apple Inc.

# CONTENTS

<b>HOW TO USE THIS MANUAL .....</b>	<b>1</b>
Safety Information .....	1
Description of Caution Symbol .....	1
<b>PART ONE.....</b>	<b>3</b>
User Basics .....	3
The Instrument .....	3
Alarms .....	3
Before Calling TSI .....	3
Model and Accessories .....	4
<b>PART TWO .....</b>	<b>5</b>
Technical Section .....	5
Laboratory Room Controller Programming Basics .....	5
Hardware Programming .....	6
Connecting to the Laboratory Room Controller using Wireless Adapter or Ethernet Connection .....	6
Menu and Menu Items .....	10
Software Programming .....	11
Programming Basics .....	11
Home Menu .....	12
I/O Setup Menu .....	13
I/O Tags Menu .....	14
Config/Calibration Menu .....	15
Setpoints Menu .....	26
Control Menu .....	38
Balance Mode Menu .....	48
Diagnostics Menu .....	49
Reset to Defaults Menu .....	49
Alarm Status Menu .....	50
Alarm Constraints .....	50
Calibration .....	51
Room Pressure Calibration.....	51
Flow Calibration .....	52
Optimizing Controller Performance.....	56
Resetting the Controller .....	56
Maintenance and Repair Parts .....	57
Regular Maintenance.....	57
System Component Inspection.....	57
Troubleshooting Section .....	58
Hardware Test .....	58
Confirming Wiring is Correct.....	58
Confirming Physical Installation is Correct .....	58
Verifying Mechanical Components .....	59
Troubleshooting Chart .....	59

<b>APPENDIX A</b> .....	<b>63</b>
Specifications* .....	63
<b>APPENDIX B</b> .....	<b>67</b>
Mounting Information .....	67
Mounting Positions .....	67
Assembly Order .....	68
DIN Rail-Mounted Installation .....	69
Wall-Mounted Installation .....	69
Dimensions .....	71
<b>APPENDIX C</b> .....	<b>73</b>
Multiple Row Configuration .....	73
<b>APPENDIX D</b> .....	<b>75</b>
Wiring Information .....	75
General Wiring Recommendations .....	75
LR-PWR Module Wiring .....	76
LR-EXP68 and LR-EXP08 Input Wiring .....	76
LR-EXP68 Output Wiring .....	77
Communications Wiring .....	78
BACnet IP .....	78
BACnet MS/TP .....	79
<b>APPENDIX E</b> .....	<b>81</b>
Wiring Connection Information .....	81
LR-PWR Power Supply Wiring .....	81
LRC00 Controller Module .....	81
LR-EXP08 Input Only Module .....	83
<b>APPENDIX F</b> .....	<b>85</b>
Creating User Profiles and Access .....	85
Creating User Profiles .....	85
<b>APPENDIX G</b> .....	<b>87</b>
Creating and Restoring a Backup File .....	87
Creating a Backup .....	87
<b>APPENDIX H</b> .....	<b>89</b>
Changing IP address from Static to Dynamic .....	89
<b>APPENDIX I</b> .....	<b>91</b>
Network Communications .....	91
Laboratory Room Controller BACnet® Protocol Implementation	
Conformance Statement .....	91
BACnet® Object Set .....	110

# How to Use This Manual

The Operation and Service Manual describes how to operate, configure, calibrate, maintain and troubleshoot the Laboratory Room Pressure Controller (LRC). The manual is divided into two parts. [Part One](#) describes the unit and how to interface with the device. This section should be read by users, facilities staff, and anyone who requires a basic understanding of how the device operates.

[Part Two](#) describes the technical aspects of the product which include operation, configuration, calibration, maintenance and troubleshooting. Part two should be read by personnel programming or maintaining the unit.

**TSI® Incorporated recommends thoroughly reading this manual before changing any software items.**

## NOTE

This operation and service manual assumes that the controller has been properly installed. Refer to the Installation Instructions if there are any questions as to whether the controller has been installed properly.

---

## Safety Information

This section gives instructions to promote safe and proper handling of Laboratory Room Controller.

There are no user-serviceable parts inside the instrument. Opening the instrument case will void the warranty. Refer all service of the unit to a qualified technician.

### Description of Caution Symbol



## CAUTION

**Caution** indicates:

- Equipment may be damaged if procedures are not followed.
- Improper settings may result in loss of containment.
- Important information about unit operation.

*(This page intentionally left blank)*



# Part One

---

## User Basics

This section is designed to provide a brief but thorough overview of the product installed. These few pages explain the purpose (The Instrument) and the operation (Useful user information, Graphical Interface, Alarms) of the product. Technical product information is available in [Part Two](#) of this manual.

---

## The Instrument

The Laboratory Room Controller (LRC) is designed to measure and control air flow volumes in laboratory, cleanroom facilities and other critical environments. It also can measure other parameters, such as room pressure differential, supply flow, exhaust flow, relative humidity, room temperature and supply air temperature as part of controlling the room.

---

## Alarms

The LRC will notify the building automation system of any alarms, but has no visual or audible alarms. The alarm levels (setpoints) are determined by facilities staff, which could be Engineering, Industrial Hygiene, or a facilities group depending on how the safety staff is organized.

---

## Before Calling TSI® Incorporated

This manual should answer most questions and resolve most problems you may encounter. For assistance or further explanation, contact your local TSI® representative or TSI®. TSI is committed to providing high quality products backed by outstanding service.

Please have the following information available prior to contacting your authorized TSI Manufacturer's Representative or TSI:

- Model number of unit\*      LRC
- Type of room pressure sensor (TSI through-the-wall sensor or pressure transducer or none)
- Software revision level\*
- Facility where unit is installed

\* Can be determined by entering the **Diagnostics** menu.

Due to the different configurations of the LRC available, the above information is needed to accurately answer your questions.

For the name of your local TSI representative or to talk to TSI service personnel, please call TSI at (800) 680-1220 (U.S. and Canada) or (001 651) 490-2860 (other countries).

Prior to shipping any components to TSI for service or repair, please utilize our convenient Service Request Form, which is available online at <https://tsi.com/focus/tsi-online-service-request/>.

---

## Model and Accessories

<b>TSI® PART NUMBER</b>	<b>ITEM DESCRIPTION</b>
LRC00	Laboratory Room Controller (Imperial Units)
LRC00-LPS	Laboratory Room Controller (Metric Units: Liters per Second)
LRC00-CMH	Laboratory Room Controller (Metric Units: Cubic Meters per Hour)
LR-PWR	Laboratory Room Controller Power Supply
LR-EXP68	Laboratory Room Controller 6 Output 8 Input Module
LR-EXP08	Laboratory Room Controller 8 Input Module
LR-WIFI	Laboratory Room Controller Wireless Adapter
LR-CABLE	Laboratory Room Controller Cable for 2 <sup>nd</sup> row
LR-DISPLAY	Laboratory Room Controller Display Unit

## Part Two

---

### Technical Section

The Laboratory Room Controller (LRC) is ready to use after being properly installed and configured. The TSI® through-the-wall sensor is factory calibrated, as are most pressure transducers. Figure 1 shows the LRC which can be easily modified to fit your application.



Figure 1: Laboratory Room Controller

The technical section is separated into five parts that cover all aspects of the unit. Each section is written as independently as possible to minimize flipping back and forth through the manual for an answer.

The [Hardware Programming](#) section explains how to program the LRC hardware. This determines what the input and output signals on the LRC will be.

The [Software Programming](#) section explains how to program the firmware and software of the LRC. In addition, the programming sequence is described, which is the same regardless of the menu item being changed.

The [Menu and Menu Items](#) section lists all of the software items available to program and change. The items are grouped by menu which means all setpoints are in one menu, control signal items in another, etc. The menu items and all related information is provided including; programming name, description of menu item, range of programmable values, and how the unit shipped from the factory (default value).

The [Calibration](#) section describes the required procedure to calibrate the controller. This section explains how to compare the controller's reading to a reference measurement.

The [Maintenance and Repair Parts](#) section covers all routine maintenance of equipment, along with a list of repair parts.

The [Troubleshooting](#) section is split into two areas: mechanical operation of the unit and system performance. Many external variables will affect how the unit functions so it is critical to first determine if the system is having mechanical problems. If no mechanical problems exist, look for performance problems (i.e., does not seem to read correctly, display fluctuates, etc.). The first step is to determine that the system is mechanically operating correctly, followed by modifying the configuration to eliminate the performance problems.

---

### Laboratory Room Controller Programming Basics

Programming the LRC requires a few basic steps.

1. Go to [tsi.com](http://tsi.com) to get the link to install DISTECH® SmartInstaller program.
  - a. Select the check box to download EC-GFX (found in the **Applications** section) and select **NEXT**. (If using Microsoft® Windows® operating system, you do not need to download Apple® computer Bonjour® networking technology). The computer must be rebooted after installation is complete.

2. [Hardware Programming](#)
  - a. Connect to the LRC using either Wireless or Ethernet.
  - b. Configure the Hardware using DISTECH® EC-GFX software, and transfer the configuration to the LRC.
3. [Software Programming](#)
  - a. Use ENVYISION® software (software embedded on the LRC) to configure all the inputs, outputs, setpoints, alarms, and settings.
4. [Calibration](#)
  - a. Use ENVYISION® software to calibrate all the devices.
5. [Optimizing Controller Performance](#)
  - a. Use ENVYISION® software to manipulate the control tuning coefficients to optimize the controller.

---

## Hardware Programming

Programming the Hardware is a fast and easy procedure. There are two main steps in hardware programming. The first step is to connect to the Laboratory Room Controller (LRC), followed by the programming of the LRC hardware. To speed up the process, it is recommended to make a list of your inputs and outputs prior to programming. This list will make programming simple. To program the Hardware, begin by connecting your computer to the LRC by using an Ethernet cable, or Wireless connector.

### Connecting to the Laboratory Room Controller using Wireless Adapter or Ethernet Connection

#### Wireless Connection

1. Connect the Wireless adapter to the LRC.
2. On your computer, open up **Network and Sharing Center**. The Network and Sharing Center can be accessed through your control panel.
  - i. Look for the wireless network option that has the word “**ECLYPSE-XXXXXX**” and select that network.
  - ii. You will be prompted to enter a password.  
Use: **eclypse1234**



#### Ethernet Connection

1. Connect the Primary Ethernet Port on the LRC to a computer with an Ethernet cable.
2. On your computer, open up **Network and Sharing Center**. Access the Network and Sharing Center through your control panel.
3. Select the Ethernet connection link that is found in the **Unidentified network** section.



4. Select **Properties** and then select **Internet Protocol Version 4 TCP/IPv4** then **Properties**.
  - a. Choose **Use the following IP address**.
  - b. Enter the **IP address: 192 . 168 . 200 . 1**

**NOTE**

This the default address. If this is not connecting, the default IP address may have been changed.

- c. Enter **Subnet mask** as follows: **255 . 255 . 255 . 0**
- d. Leave the **Default gateway** blank.

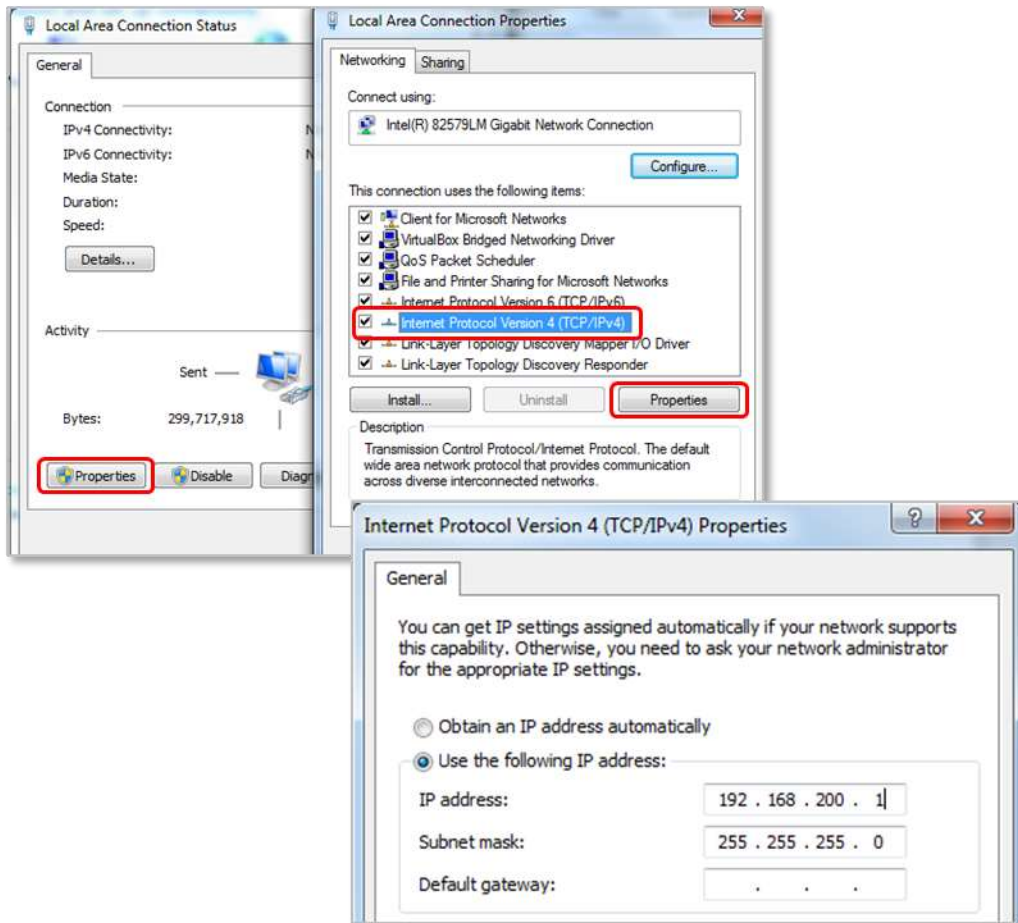

### Configuring the Hardware

1. Open EC-GFX Program.



2. Enter the following settings into the **Connect to Server** dialog box.

<b>Server Type:</b>	REST
<b>Connection mode:</b>	Secure (HTTPS)
<b>Server address:</b>	192.168.200.90 for Ethernet, 192.168.0.1 for Wireless )
<b>Server Port:</b>	443
<b>Username:</b>	admin
<b>Password:</b>	Tsi12345

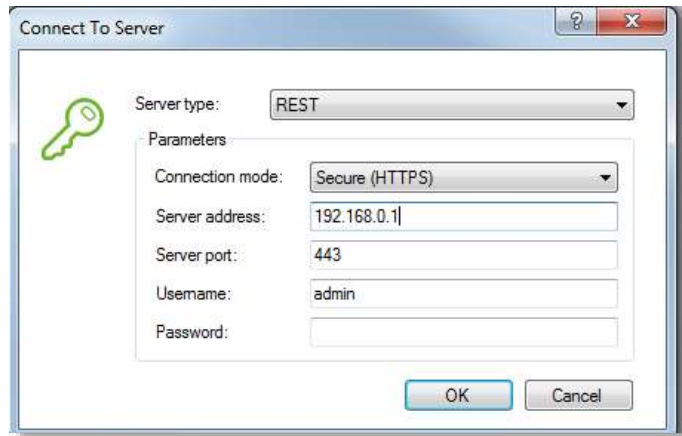

3. Your device will appear starting with the letters **ECY-**.
4. Select the device.
5. Select **OK**.

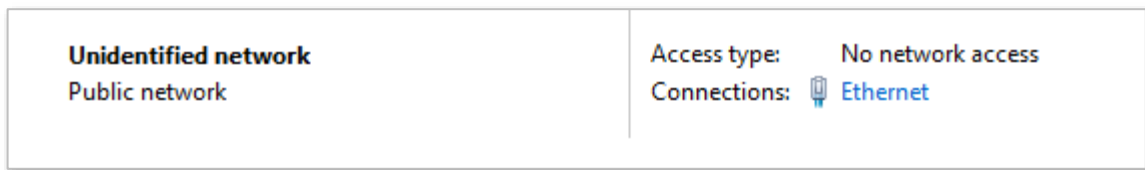
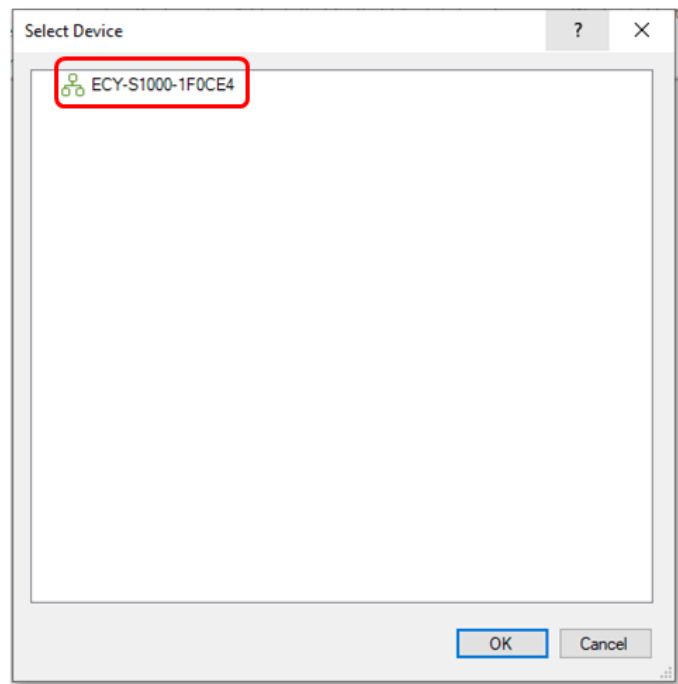

6. A Configuration window will appear.
7. Configure the Inputs (1 to 32) for your LRC. Information is found in the submittal.

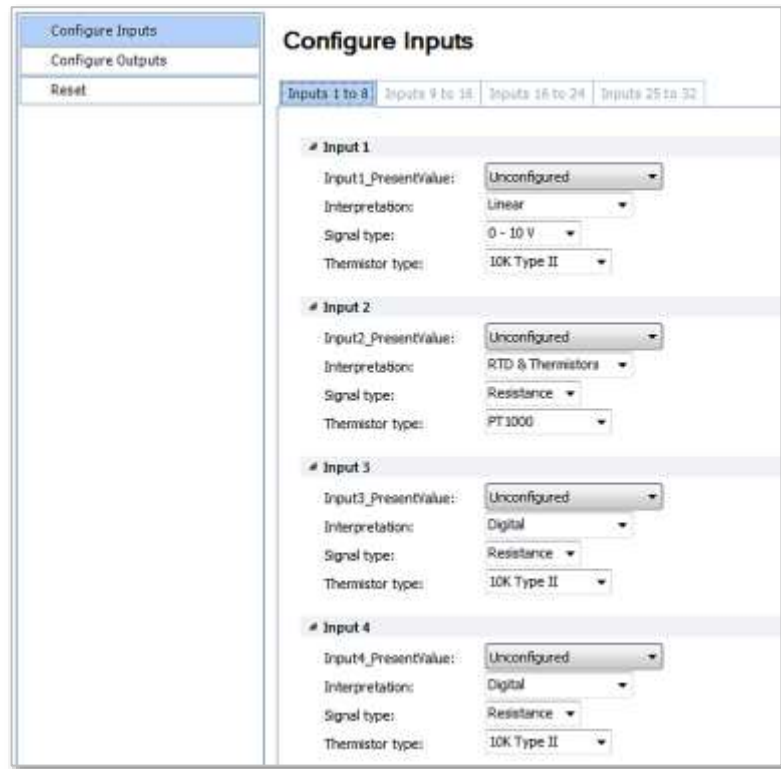

Input PresentValue	Interpretation	Signal Type	Thermistor Type
Flow (supply, exhaust, fume hood)	Linear	0–10V	Not used
DAT (Discharge Air Temp)	Linear	0–10V	Not used
Relative Humidity	Linear	0–10V	Not used
Temp Setpoint (Adjustment)	Linear	0–10V	Not used
Room Pressure	Linear	0–10V	Not used
Door Switch	Digital	0–10V	Not used
Occupancy Switch	Digital	0–10V	Not used
Emergency Switch	Digital	0–10V	Not used
Shutdown Switch	Digital	0–10V	Not used
Room Temp (sensor)	RTD&Thermistor	Resistance	PT1000

8. Configure the Outputs (1 to 12) for your LRC. Information is found in the submittal.
  - Select the output type from the present value drop-down menu (Supply 1 Flow, Supply 2 Temp, Exhaust 1 Flow... etc.)
  - Select the type of signal from the Signal Type value drop-down menu
    - Analog 0–10 V—TSI® actuators
    - Analog 0–20 mA
9. Once all changes are complete click the **Save** button.
10. Select **Download to device**.
11. Select **Next**.
12. Select **Finish**.
13. Close EC-GFX program.



## WARNING

Be sure to select the appropriate signal type. The only place to manipulate the signal type is in the EC-GFX program.

### Configuring the Software

1. Open an internet browser and type the address for the LRC.
  - <https://192.168.200.90> is default for Ethernet
  - <https://192.168.0.1> is default for Wireless
2. Click on **Advanced** and then click on **Proceed to site**.
3. Use the admin credentials to Login to the controller.

<b>Username:</b>	integrator
<b>Password:</b>	Tsi12345



---

## Menu and Menu Items

The TSI® Laboratory Room Controllers (LRC) are very versatile devices which can be configured to meet your specific application. This section lists all of the menu items available to program and change (except Diagnostics menu). Changing items is accomplished by using the software or through communications with the Building Automation System. If you are unfamiliar with the procedure please see [Software Programming](#) section for a detailed explanation. This section provides the following information:

- Complete list of menus and all menu items.
- Gives the menu or programming name.
- Defines each menu item's function; what it does, how it does it, etc.
- Gives the range of values that can be programmed.
- Gives default item value (how it shipped from factory).

The menus covered in this section are divided into groups of related items to ease programming. As an example all setpoints are in one menu, alarm information in another, etc. The manual follows the menus as programmed in the controller. The menu items are always grouped by menu and then listed in menu item order, not alphabetical order.



## Software Programming

Programming the Laboratory Room Controller is done through the ENVYISION® software imbedded on the LRC. The inputs and outputs will already be in the software when you begin to program the LRC.

On the left side of the screen is a list of menu options. The rest of the screen is where the data will be displayed and where settings can be changed. To change the setting:

1. Move the mouse over the space to be edited.
2. Right-click and left-click on **Set Value**.
3. Change the value.
4. Select **Apply**.

### NOTE

**DO NOT** use the **Override** option! If the override option is used, a purple circle will appear denoting the override.

## Programming Basics

The screenshot shows the 'Supply 1 Flow Calibration' interface. It features a table with columns for 'Input Number', 'Tag', and 'Input Voltage'. Below the table, there are fields for 'Supply 1 Flow' (0.0 cfm) and 'Supply 1 Flow Type' (Linear). A 'Linear Calibration' panel on the right lists parameters like 'Supply 1 Linear Duct Area', 'Supply 1 Linear Top Velocity', 'Supply 1 Linear Signal Minimum', 'Supply 1 Linear Signal Maximum', and 'Supply 1 Flow K Factor'. A context menu is open over the 'Linear' flow type, showing options: 'Emergency Override', 'Emergency Auto', 'Override', 'Auto', and 'Set Value'. A 'Value:' dropdown menu is also open, showing 'Linear' as the selected value. Below the dropdown are 'Cancel' and 'Apply' buttons, and a 'result:' field.

1) Right-click here to bring up the first window starting with "Emergency Override."

2) Hover over "Set Value." A second window will appear starting with "Value."

3) Left-click the drop-down box after "Value" and edit to your needs.

4) Click "Apply".

5) The Result box below will display "Success."

## Home Menu



The **Home** screen only displays the high level data for the room. Items displayed are:

- Room Mode
- Offset Setpoint
- Current Total Supply Flow
- Current Total Exhaust Flow
- Current Offset
- Pressure Mode
- Room Pressure

## I/O Setup Menu



The **Input and Output Setup** allows for configuration of all the inputs and outputs for the LRC.

MENU ITEM	SOFTWARE NAME	ITEM DESCRIPTION	ITEM RANGE	DEFAULT
Inputs	<ul style="list-style-type: none"> <li>Input 1–8 Input Type</li> <li>Input 9–16 Input Type</li> <li>Input 17–24 Input Type</li> <li>Input 25–32 Input Type</li> </ul>	<p>The <b>Input #</b> item selects the desired input type for that specific input.</p> <p><b>NOTE:</b> If you select an option that is already used, the software will default back to <b>Unconfigured</b>.</p>	<ul style="list-style-type: none"> <li>Supply Flow</li> <li>Supply Discharge Air Temp</li> <li>Room Temp</li> <li>Temp Setpoint</li> <li>Occupancy</li> <li>Exhaust Flow</li> <li>Hood Flow</li> <li>Room Pressure</li> <li>Relative Humidity</li> <li>Door Switch</li> <li>Emergency Switch</li> <li>Shutdown Switch</li> </ul>	<b>Unconfigured</b>
Outputs	<ul style="list-style-type: none"> <li>Output 1–6 Output Type</li> <li>Output 7–12 Output Type</li> </ul>	<p>The <b>Output #</b> item selects the desired output type for that specific output.</p> <p><b>NOTE:</b> If an option is selected that is already used, the software will default back to <b>Unconfigured</b>.</p>	<ul style="list-style-type: none"> <li>Supply # Flow</li> <li>Exhaust # Flow</li> <li>Supply # Temp</li> </ul>	<b>Unconfigured</b>

## I/O Tags Menu



The **I/O Tags** menu allows for tagging all the inputs and outputs on the controller. This tagging makes it easier to recognize the device.

MENU ITEM	SOFTWARE NAME	ITEM DESCRIPTION	ITEM RANGE	DEFAULT
Supply Tags	<ul style="list-style-type: none"> <li>Supply # XXX</li> </ul>	The <b>Supply Tags</b> item allows for individual device naming for ease of recognition in programming, and startup.	23 characters	<b>Name matched input name</b>
Hood Tags	<ul style="list-style-type: none"> <li>Hood # Flow</li> </ul>	The <b>Hood Tags</b> item allows for individual fume hood naming for ease of recognition in programming, and startup.	23 characters	<b>Name matched Hood name</b>
Exhaust & Other Tags	<ul style="list-style-type: none"> <li>Exhaust # Flow</li> <li>Room Pressure</li> <li>Door Switch</li> <li>Shutdown Switch</li> <li>Relative Humidity</li> <li>Emergency Switch</li> </ul>	The <b>Exhaust &amp; Other Tags</b> item allows for individual device naming for ease of recognition in programming, and startup.	23 characters	<b>Name matched exhaust name</b>

## Config/Calibration Menu

The **Config/Calibration** menu allows for configuration and calibration of all the inputs and outputs on the LRC.

### Flows Menu (Supply # / Exhaust # / Hood #)



The **Flows** menu allows for configuration and calibration of the supply, exhaust, and hood flows. The first item to change is the **Flow Type**. Once that is complete, the appropriate calibration window will appear allowing for inputting the appropriate values.

MENU ITEM	SUBMENU NAME	ITEM DESCRIPTION	ITEM RANGE/OPTIONS	DEFAULT
<b>Applies for: Supply # (1–6), Exhaust # (1–2), Hood # (1–20)</b>				
<b># Flow Type</b>	N/A	The <b># Flow Type</b> selects the desired flow type for each individual input. Once the flow type is selected, the specific calibration factors will appear.	<ul style="list-style-type: none"> <li>▪ Linear Flow</li> <li>▪ Pitot Tube</li> <li>▪ Venturi Valve</li> </ul>	<b>Unconfigured</b>
<b># Linear Calibration</b>	<b># Linear Duct Area</b>	The <b># Linear Duct Area</b> sets the duct area.	0–10 ft <sup>2</sup> (0–1 m <sup>2</sup> )	<b>0.0 FT<sup>2</sup></b>
	<b># Linear Top Velocity</b>	The <b># Linear Top Velocity</b> sets the top velocity on the linear flow station.	0–5,000 FPM (0–25 m/s)	<b>3,000.0 FPM (15 m/s)</b>
	<b># Linear Signal Minimum</b>	The <b># Linear Signal Minimum</b> sets the minimum voltage for the linear flow station.	0–10 V	<b>0.0 V</b>
	<b># Linear Signal Maximum</b>	The <b># Linear Signal Maximum</b> sets the Maximum voltage for the linear flow station.	0–10 V	<b>10.0 V</b>

MENU ITEM	SUBMENU NAME	ITEM DESCRIPTION	ITEM RANGE/OPTIONS	DEFAULT	
# Linear Calibration (cont.)	# Linear Flow K Factor	The # <b>Linear Flow K Factor</b> adjusts the flow calibration to match reference measurement (such as from an air balancer). The K-factor is a linear adjustment to the flow measurement. To calculate a new K-Factor, use the formula below.	0.01–2	1.0	
		$\text{New K Factor} = \frac{(\text{Reference Measurement} \times \text{Starting K Factor})}{\text{Controller Reading}}$			
# Venturi Calibration	# Venturi Flow Minimum Flow	The # <b>Venturi Flow Minimum Flow</b> sets flow rate when the Venturi Valve is at the minimum position.	0–50,000 CFM (0–5,000 LPS) (0–17,000 CMH)	0.0 CFM/LPS/ CMH	
	# Venturi Flow Maximum Flow	The # <b>Venturi Flow Maximum Flow</b> sets flow rate when the Venturi Valve is at the maximum position.	0–50,000 CFM (0–5,000 LPS) (0–17,000 CMH)	0.0 CFM/LPS/ CMH	
	# Venturi LOM Esc Time	The # <b>Venturi LOM Esc Time</b> sets the amount of time the controller will delay entering LOM alarm mode.	1–120 seconds	30.0 seconds	
	# Venturi Setup Position	The # <b>Venturi Setup Position</b> sets position when the Venturi Valve is in Setup Mode.	0–80%	30.0%	
	# Venturi Flow K Factor	# Venturi Flow K Factor	The # <b>Venturi Flow K Factor</b> adjusts the flow calibration to match reference measurement (such as from an air balancer). The K-factor is a linear adjustment to the flow measurement. To calculate a new K-Factor, use the formula below.	0.01–2	1.0
			$\text{New K Factor} = \frac{(\text{Reference Measurement} \times \text{Starting K Factor})}{\text{Controller Reading}}$		
# Pitot Calibration	# Pitot Duct Area	The # <b>Pitot Duct Area</b> sets the duct area.	0–10 FT <sup>2</sup> (0–1 <sup>2</sup> )	0.0 FT <sup>2</sup>	
	# Transducer Signal Minimum	The # <b>Transducer Signal Minimum</b> sets the minimum voltage for the pitot pressure transducer.	0–10 V	0.0 V	
	# Transducer Signal Maximum	The # <b>Transducer Signal Maximum</b> sets the maximum voltage for the pitot pressure transducer.	0–10 V	0.0 V	
	# Transducer Sensor Maximum	The # <b>Pitot Sensor Maximum</b> sets the maximum pressure value when the pressure transducer is at maximum.	1.0 inH <sub>2</sub> O	1.0 in H <sub>2</sub> O (250 Pa)	
	# Pitot Low Cal Pos	The # <b>Pitot Low Cal Pos</b> sets position of the damper for the calibration of the low point.	0–100%	20.0%	
	# Pitot Low Cal Flow	The # <b>Pitot Low Cal Flow</b> sets the flow rate when the damper is in the low cal position.	0–50,000 CFM (0–5,000 LPS) (0–17,000 CMH)	0.0 CFM/LPS/ CMH	

MENU ITEM	SUBMENU NAME	ITEM DESCRIPTION	ITEM RANGE/OPTIONS	DEFAULT
# Pitot Calibration (cont.)	# Pitot High Cal Pos	The # <b>Pitot High Cal Pos</b> sets position of the damper for the calibration of the high point.	0–100%	75.0%
	# Pitot High Cal Flow	The # <b>Pitot High Cal Flow</b> sets the flow rate when the damper is in the high cal position.	0–50,000 CFM (0–5,000 LPS) (0–17,000 CMH)	0.0 CFM/LPS/ CMH
	# Pitot Flow K Factor	The # <b>Pitot Flow K Factor</b> adjusts the flow calibration to match reference measurement (such as from an air balancer). The K-factor is a linear adjustment to the flow measurement. To calculate a new K-Factor, use the formula below.	0–2.0	1.0
	<i>New K Factor = <math>\frac{\text{Reference Measurement} \times \text{Starting K Factor}}{\text{Controller Reading}}</math></i>			
	# Pitot Cal Mode	The # <b>Pitot Cal Mode</b> sets the calibration mode for the pitot flow station. <b>SAVE</b> means the device is not in calibration mode. <b>LOW CAL MODE</b> means the controller has moved the damper to <b>LOW CAL POS.</b> <b>HIGH CAL MODE</b> means the controller has moved the damper to <b>HIGH CAL POS.</b>	<ul style="list-style-type: none"> <li>▪ Save</li> <li>▪ Low Cal Mode</li> <li>▪ High Cal Mode</li> <li>▪ Sensor Zero</li> </ul>	Save
# Two Position Calibration <b>NOTE:</b> Hoods only	# TP Min Flow	The # <b>TP Min Flow</b> sets the flow rate when the air flow control device is closed.	0–50,000 CFM (0–15,000 LPS) (0–51,000 CMH)	0.0 CFM/LPS/ CMH
	# TP Max Flow	The # <b>TP Max Flow</b> sets the flow rate when the air flow control device is open.	0–50,000 CFM (0–15,000 LPS) (0–51,000 CMH)	0.0 CFM/LPS/ CMH
	# TP Max Flow Signal	The # <b>TP Max Flow Signal</b> selects the signal type for maximum flow.	Open or Closed	Open
Exhaust	Exhaust Config	The <b>Exhaust Config</b> toggle determines the exhaust duct configuration. If the general exhaust duct flow is <b>NOT</b> accounted for in the total exhaust measurement, select <b>UNGANGED</b> (see left image). If the general exhaust duct flow <b>IS</b> included in the total exhaust flow, then select <b>GANGED</b> (see right image).	<ul style="list-style-type: none"> <li>▪ Unganged</li> <li>▪ Ganged</li> </ul>	Unganged



## DAT Menu



The **DAT** menu allows for configuration and calibration of the supply **Discharge Air Temperature**. Enter sensor and signal minimums and maximums. Using a higher accuracy reference measurement, calibrate the DAT sensor by manipulating the **DAT Offset**.

MENU ITEM	SOFTWARE NAME	ITEM DESCRIPTION	ITEM RANGE	DEFAULT
<b>Applies for: Supply # DAT (1–6)</b>				
<b>Supply # DAT type</b>	N/A	The <b>Supply # DAT type</b> shows the type of sensor already selected.	<ul style="list-style-type: none"> <li>▪ 0-10V</li> <li>▪ RTD</li> </ul>	<b>Prior Selected</b>
<b>DAT Configuration</b>	<b>Supply # DAT Offset</b>	The <b>Supply # Room Temp Offset</b> allows matching the measured discharge air temperature to what is measured from the DAT sensor.	-10°F–10°F (-6°C–6°C)	<b>10°F</b>
<b>DAT 0–10V Calibration</b>	<b>Supply # DAT Signal Minimum</b>	The <b>Supply # DAT Signal Minimum</b> sets the minimum voltage for the discharge air temperature sensor.	0–10 V	<b>0.0 V</b>
	<b>Supply # DAT Signal Maximum</b>	The <b>Supply # DAT Signal Maximum</b> sets the maximum voltage for the discharge air temperature sensor.	0–10 V	<b>10.0 V</b>
	<b>Supply # DAT Sensor Minimum</b>	The <b>Supply # DAT Sensor Minimum</b> sets the minimum temperature for the discharge air temperature sensor.	-20.0°F–190.0°F (-29°C)	<b>-20.0°F (-29 C)</b>
	<b>Supply # DAT Sensor Maximum</b>	The <b>Supply # DAT Sensor Maximum</b> sets the maximum temperature for the discharge air temperature sensor.	-20.0°F–190.0°F (88°C)	<b>190.0°F (88°C)</b>



## Room Temp Menu

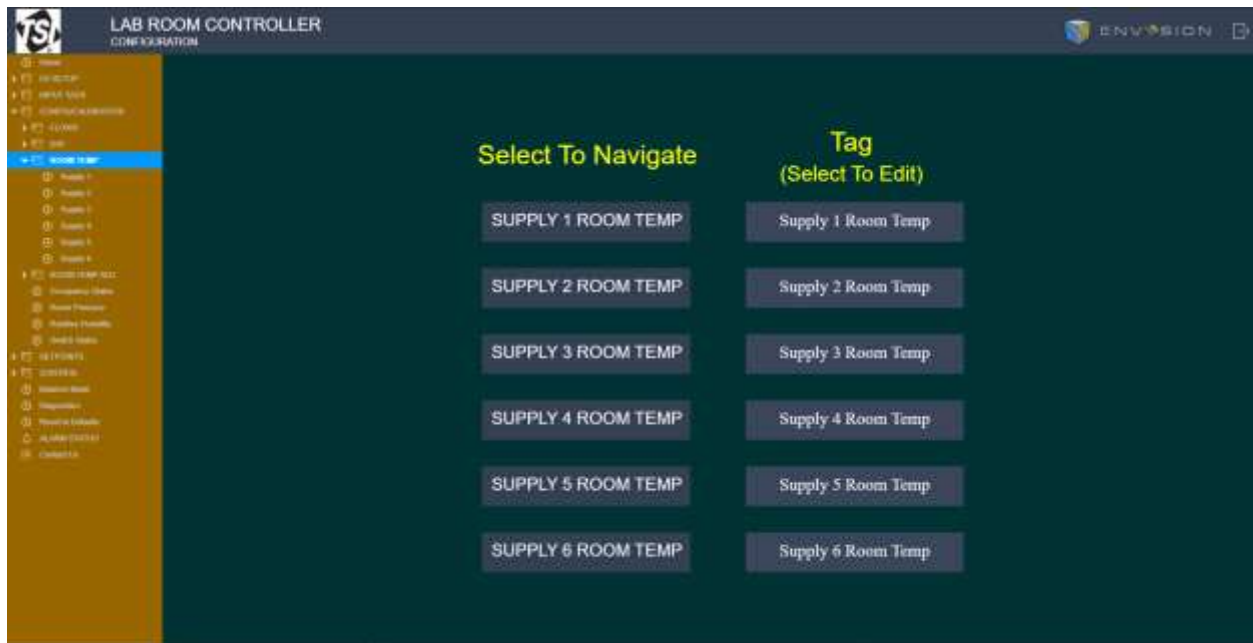

The **Room Temp** menu allows for configuration and calibration of the Room Temperature. Using a higher accuracy reference measurement, you can calibrate the DAT sensor by manipulating the DAT Offset.

MENU ITEM	SOFTWARE NAME	ITEM DESCRIPTION	ITEM RANGE	DEFAULT
<b>Applies to: Supply # Room Temp (1-6)</b>				
<b>Room Temp</b>	<b>Supply # Room Temp Offset</b>	The <b>Supply # Room Temp Offset</b> matches the measured room temperature to what is measured from the room sensor.	-10°F–10°F (-6°C–6°C)	<b>0.0°F (0.0°C)</b>

### NOTE

If there is more than one supply configured on the Lab Room Controller, but only one temperature input, the LRC will use the value from the Supply 1 Temp Sensor input.

## Room Temp Adj Menu



The **Room Temp Adj** menu allows for configuration of the room temperature sensor signal minimums and maximums, and well as setting the minimum and maximum allowable user setpoint changes.

MENU ITEM	SOFTWARE NAME	ITEM DESCRIPTION	ITEM RANGE	DEFAULT
<b>Applies to: Supply # Room Temp Adjustment (1-6)</b>				
<b>Room Temp Adjustment Configuration</b>	<b>Supply # Room Temp Adj Signal Minimum</b>	The <b>Supply # Room Temp Adj Signal Minimum</b> sets the minimum voltage for the room temperature sensor.	0–10 V	<b>0.0 V</b>
	<b>Supply # Room Temp Adj Signal Maximum</b>	The <b>Supply # Room Temp Adj Signal Maximum</b> sets the maximum voltage for the room temperature sensor.	0–10 V	<b>0.0 V</b>
	<b>Supply # Room Temp Adj Sensor Minimum</b>	The <b>Supply # Room Temp Adj Sensor Minimum</b> sets the minimum value for changing the room temperature.	-10°F–10°F (-6°C–6°C)	<b>0.0°F (0.0°C)</b>
	<b>Supply # Room Temp Adj Sensor Maximum</b>	The <b>Supply # Room Temp Adj Sensor Maximum</b> sets the maximum value for changing the room temperature.	-10°F–10°F (-6°C–6°C)	<b>10.0°F (6.0°C)</b>

## Occupancy Status Menu

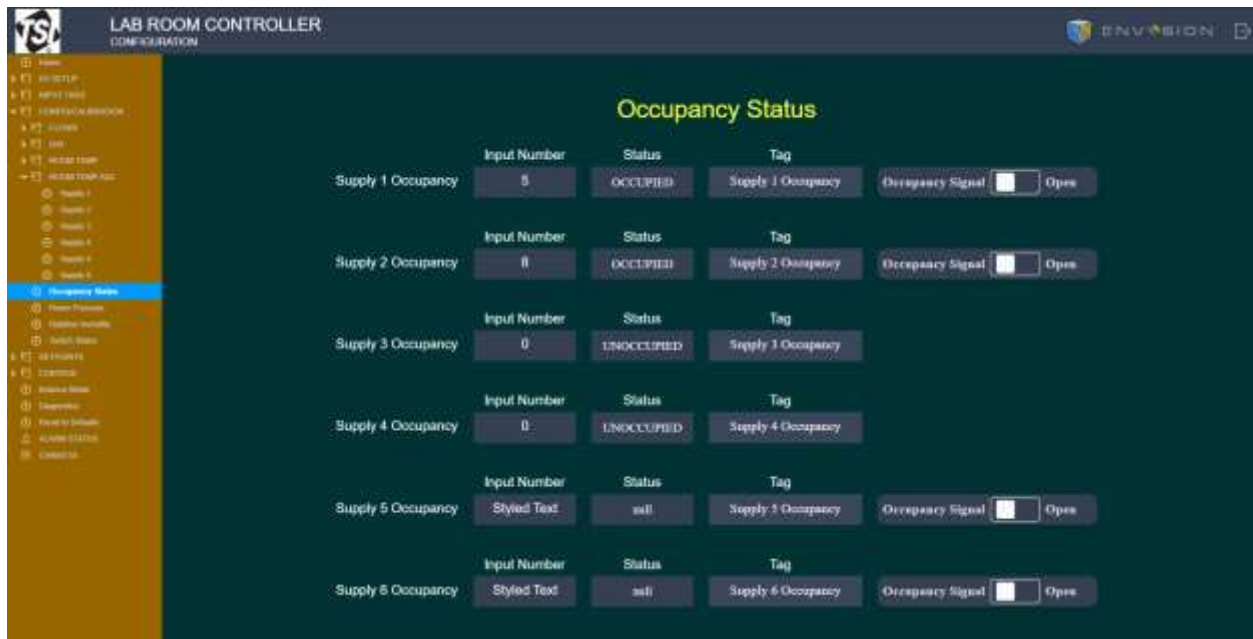

The **Occupancy Status** menu allows for configuration of the occupancy switches. Use the slider to configure switch status.

MENU ITEM	SOFTWARE NAME	ITEM DESCRIPTION	ITEM RANGE	DEFAULT
<b>Applies to: Supply # Occupancy (1–6)</b>				
<b>Supply # Occupancy</b>	<b>Status</b>	Displays current occupancy status on the controller.	<ul style="list-style-type: none"> <li>Occupied</li> <li>Unoccupied</li> </ul>	<b>Occupied</b>
	<b>Occupancy Signal</b>	Toggle for occupancy signal open or closed.	<ul style="list-style-type: none"> <li>Open</li> <li>Closed</li> </ul>	<b>Open</b>

## Room Pressure Menu



The **Room Pressure** menu allows for configuration of which type of room pressure sensor is used, as well as calibration. See the section on [calibration](#) for more details.

MENU ITEM	SOFTWARE NAME	ITEM DESCRIPTION	ITEM RANGE	DEFAULT
<b>Room Pressure Type</b>	N/A	The <b>Room Pressure Type</b> selects what type of sensor is used for sensing room pressure.	<ul style="list-style-type: none"> <li>TTW Sensor</li> <li>Pressure Transducer</li> </ul>	<b>Unconfigured</b>
<b>Room Pressure Cal Mode</b>	N/A	Selecting <b>Sensor Zero</b> resets the sensor zero point.	<ul style="list-style-type: none"> <li>Save</li> <li>Sensor Zero</li> </ul>	<b>Save</b>
<b>TTW Sensor Calibration</b>	<b>TTW Sensor Elevation</b>	The <b>TTW Sensor Elevation</b> item is used to enter the elevation of the building above sea level. The pressure value needs to be corrected due to changes in air density at different elevations.	0–10,000 ft (3050 m)	<b>0.0 ft (0.0 m)</b>
	<b>Velocity K-Factor</b>	The <b>Velocity K-Factor</b> item is used to match or calibrate the TSI® pressure sensor (velocity sensors) to the average room pressure velocity as measured by a portable air velocity meter.  A sensor zero should be established prior to adjusting the sensor span, if the sensor was cleaned with a liquid cleaner (see <a href="#">Calibration</a> section following menu item listing).	0.0–10.0 <b>Unit is factory calibrated. No initial adjustment should be necessary</b>	<b>0.0</b>

<b>MENU ITEM</b>	<b>SOFTWARE NAME</b>	<b>ITEM DESCRIPTION</b>	<b>ITEM RANGE</b>	<b>DEFAULT</b>
<b>Pressure Transducer Calibration</b>	<b>Pressure Transducer Signal Minimum</b>	The <b>Pressure Transducer Signal Minimum</b> sets the minimum voltage for the pressure transducer sensor.	0–10 V	<b>0.0 V</b>
	<b>Pressure Transducer Signal Maximum</b>	The <b>Pressure Transducer Signal Maximum</b> sets the maximum voltage for the pressure transducer sensor.	0–10 V	<b>10.0 V</b>
	<b>Pressure Transducer Sensor Minimum</b>	The <b>Pressure Transducer Sensor Minimum</b> sets the minimum pressure for the pressure transducer sensor.	-1.0–1.0 in H <sub>2</sub> O (-250 Pa–250 Pa)	<b>-1.0 in H<sub>2</sub>O (-250 Pa)</b>
	<b>Pressure Transducer Sensor Maximum</b>	The <b>Pressure Transducer Sensor Maximum</b> sets the maximum pressure for the pressure transducer sensor.	-1.0–1.0 in H <sub>2</sub> O (-250 Pa–250 Pa)	<b>1.0 in H<sub>2</sub>O (250 Pa)</b>

## Relative Humidity Menu

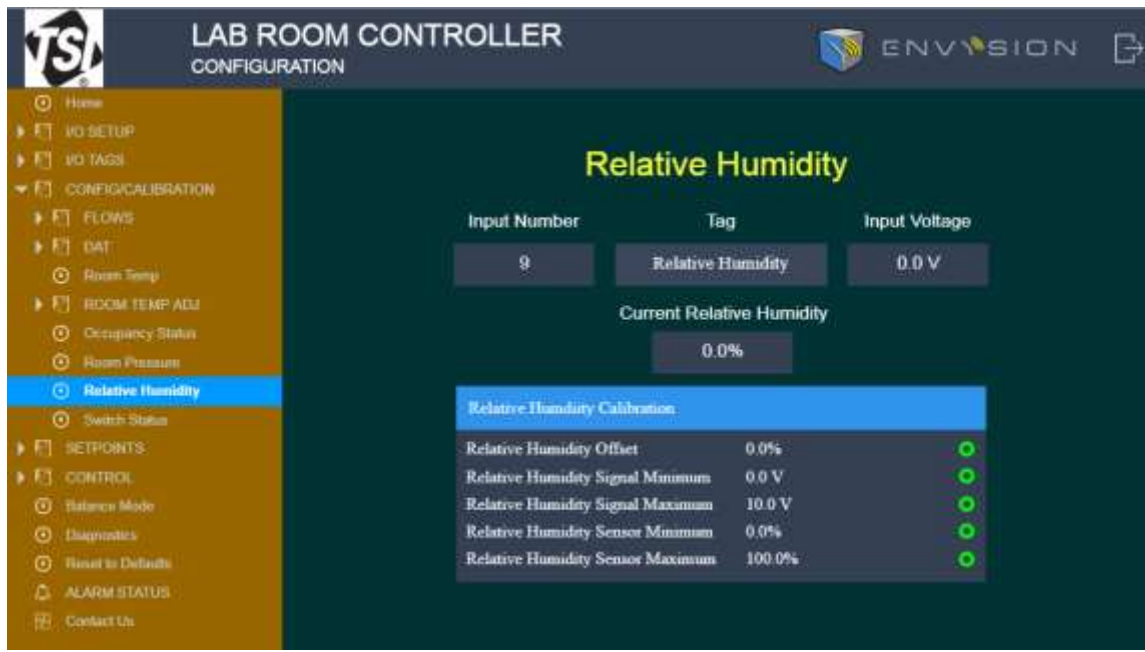

The **Relative Humidity** menu allows for configuration and calibration of the relative humidity sensor.

Enter sensor and signal minimums and maximums. Use a higher accuracy reference measurement to calibrate the Relative Humidity sensor by manipulating the **Relative Humidity Offset**.

MENU ITEM	SOFTWARE NAME	ITEM DESCRIPTION	ITEM RANGE	DEFAULT
Relative Humidity Calibration	Relative Humidity Offset	The <b>Relative Humidity Offset</b> matches the measured relative humidity to what is measured from the relative humidity sensor.	-10%–10%	<b>0.0%</b>
	Relative Humidity Signal Minimum	The <b>Relative Humidity Signal Minimum</b> sets the minimum voltage for the relative humidity sensor.	0–10 V	<b>0.0 V</b>
	Relative Humidity Signal Maximum	The <b>Relative Humidity Signal Maximum</b> sets the maximum voltage for the relative humidity sensor.	0–10 V	<b>10.0 V</b>
	Relative Humidity Sensor Minimum	The <b>Relative Humidity Sensor Minimum</b> sets the minimum value for the relative humidity sensor.	0–100%	<b>0.0%</b>
	Relative Humidity Sensor Maximum	The <b>Relative Humidity Sensor Maximum</b> sets the maximum value for the relative humidity sensor.	0–100%	<b>100.0%</b>

## Switch Status Menu



The **Switch Status** menu allows for configuration of the Door, Emergency, or Shutdown switches. Use the slider to configure the switch status.

MENU ITEM	SOFTWARE NAME	ITEM DESCRIPTION	ITEM RANGE	DEFAULT
Door Switch	Door Status	Displays current door status on the controller.	<ul style="list-style-type: none"> <li>Open</li> <li>Closed</li> </ul>	Open
	Door Open Signal	The <b>Door Status</b> slide bar toggles the status of the door switch to either open or closed based upon door switch characteristics.	<ul style="list-style-type: none"> <li>Open</li> <li>Closed</li> </ul>	Closed
Emergency Switch	Emergency Status	Displays current emergency status on the controller.	<ul style="list-style-type: none"> <li>Emergency</li> <li>Normal</li> </ul>	Emergency
	Emergency Signal	The <b>Emergency Status</b> slide bar toggles the status of the Emergency switch to either open or closed based upon Emergency switch characteristics.	<ul style="list-style-type: none"> <li>Open</li> <li>Closed</li> </ul>	Closed
Shutdown Switch	Shutdown Status	Displays current shutdown status on the controller.	<ul style="list-style-type: none"> <li>Normal</li> <li>Shutdown</li> </ul>	Normal
	Shutdown Signal	The <b>Shutdown Status</b> slide bar toggles the status of the Shutdown switch to either open or closed based upon the Shutdown switch characteristics.	<ul style="list-style-type: none"> <li>Open</li> <li>Closed</li> </ul>	Closed



# Setpoints Menu

## Offset and Pressure Menu



The **Offset and Pressure** menu allows for configuration of the room offset and pressure setpoints. Enter the Minimum and Maximum Offset or Pressure Setpoint per the project. If offset or pressure alarms are required, configure them by giving them a value other than 0.

MENU ITEM	SUBMENU NAME	ITEM DESCRIPTION	ITEM RANGE/OPTIONS	DEFAULT
Offset	Minimum Offset	The <b>Minimum Offset</b> item sets the minimum air flow offset between total exhaust flow (fume hood, general exhaust, other exhaust) and total supply flow.	-10,000–10,000 CFM (-5,000–5,000 LPS) (-17,000–17,000 CMH)	<b>0.0 CFM/LPS/CMH</b>
	Maximum Offset	The <b>Maximum Offset</b> item sets the maximum air flow offset between total exhaust flow (fume hood, general exhaust, other exhaust) and total supply flow.	-10,000–10,000 CFM (-5,000–5,000 LPS) (-17,000–17,000 CMH)	<b>0.0 CFM/LPS/CMH</b>
Offset Alarm Setpoints	Minimum Offset Alarm	The <b>Minimum Offset Alarm</b> sets the low value at which the alarm will occur once the offset goes below.	-10,000–10,000 CFM (-5,000–5,000 LPS) (-17,000–17,000 CMH)	<b>0.0 CFM/LPS/CMH</b>
	Maximum Offset Alarm	The <b>Maximum Offset Alarm</b> sets the low value at which the alarm will occur once the offset goes above.	-10,000–10,000 CFM (-5,000–5,000 LPS) (-17,000–17,000 CMH)	<b>0.0 CFM/LPS/CMH</b>



MENU ITEM	SUBMENU NAME	ITEM DESCRIPTION	ITEM RANGE/OPTIONS	DEFAULT
Pressure	Room Pressure Setpoint	<p>The <b>Room Pressure Setpoint</b> item sets the pressure control setpoint. The LRC will maintain this setpoint, negative or positive, under normal operating conditions.</p> <p>Pressure differential is not maintained by direct pressure control; i.e., modulating dampers in response to pressure changes. The pressure signal is an adaptive offset input that is used to calculate the required air flow offset value. The calculated offset value changes the supply (or exhaust) flow volume which changes the pressure differential. When the calculated offset value is between the <b>Minimum Offset</b> and <b>Maximum Offset</b>, room pressure control can be maintained. If the offset required to maintain pressure is less than the <b>Minimum Offset</b> or greater than <b>Maximum Offset</b>, pressure control will not be maintained.</p>	-0.2–0.2 in H <sub>2</sub> O (-50 Pa–50 Pa)	<b>0.0 in H<sub>2</sub>O (0 Pa)</b>
	Door Room Pressure Setpoint	<p>The <b>Door Room Pressure Setpoint</b> item sets an alternate control setpoint. The LRC will maintain the room pressure at the alternate setpoint when this item is enabled.</p> <p><b>NOTE:</b> The <b>Door Room Pressure Setpoint</b> disables the <b>Alarm Delay</b>.</p>	-0.2–0.2 in H <sub>2</sub> O (-50 Pa–50 Pa)	<b>0.0 in H<sub>2</sub>O (0 Pa)</b>

MENU ITEM	SUBMENU NAME	ITEM DESCRIPTION	ITEM RANGE/OPTIONS	DEFAULT
Room Pressure Alarm Setpoints	Low Pressure Alarm	The <b>Low Pressure Alarm</b> item sets the low pressure alarm setpoint. A low alarm condition is defined as when the room pressure falls below or goes in the opposite direction of the <b>Low Pressure Alarm</b> setpoint.	-0.2–0.2 in H <sub>2</sub> O (-50 Pa–50 Pa)	<b>0.0 in H<sub>2</sub>O (0 Pa)</b>
	High Pressure Alarm	The <b>High Pressure Alarm</b> item sets the high pressure alarm setpoint. A high alarm condition is defined as when the room pressure rises above the <b>High Pressure Alarm</b> setpoint.	-0.2–0.2 in H <sub>2</sub> O (-50 Pa–50 Pa)	<b>0.0 in H<sub>2</sub>O (0 Pa)</b>
	Door Low Pressure Alarm	The <b>Door Low Pressure Alarm</b> item sets the low pressure alarm setpoint when the door is open. A low alarm condition is defined as when the room pressure falls below or goes in the opposite direction of the <b>Door Low Pressure Alarm</b> setpoint.	-0.2–0.2 in H <sub>2</sub> O (-50 Pa–50 Pa)	<b>0.0 in H<sub>2</sub>O (0 Pa)</b>
	Door High Pressure Alarm	The <b>Door High Pressure Alarm</b> item sets the high pressure alarm setpoint when the door is open. A high alarm condition is defined as when the room pressure rises above the <b>Door High Pressure Alarm</b> setpoint.	-0.2–0.2 in H <sub>2</sub> O (-50 Pa–50 Pa)	<b>0.0 in H<sub>2</sub>O (0 Pa)</b>

## Supply Flow Setpoints Menu



The **Supply Flow Setpoints** menu allows for configuration of the supply flow setpoints. Enter the Minimum and Maximum Supply Flows for the occupied mode for the room. Unoccupied setpoints can be entered here as well to save energy during unoccupied mode. Fixed setpoints minimum and maximum position can be used to limit the position of air control devices if needed. Emergency and shutdown flow setpoints are used as the flow setpoint to control to in those modes. Flow setpoint alarms are set and activated here.

MENU ITEM	SUBMENU NAME	ITEM DESCRIPTION	ITEM RANGE/ OPTIONS	DEFAULT
<b>Applies to: Supply # (1–6)</b>				
<b>Supply # Occupied Flow Setpoints</b>	<b>Supply # Minimum Flow</b>	<p>The <b>Supply # Minimum Flow</b> sets the minimum supply air flow setpoint. This item provides a minimum supply air flow to meet the ventilation requirement, by preventing the supply flow from going below the preset minimum flow.</p> <p>The controller will not allow the supply air damper to be closed further than the <b>Supply # Ventilation minimum</b> setpoint. If room pressure is not maintained at minimum supply flow, the general exhaust damper modulates open until pressure setpoint is reached (provided offset is between <b>Minimum Offset</b> and <b>Maximum Offset</b>).</p>	0–50,000 CFM (0–15000 LPS) (0–51000 CMH)	<b>0.0 CFM/LPS/ CMH</b>

MENU ITEM	SUBMENU NAME	ITEM DESCRIPTION	ITEM RANGE/ OPTIONS	DEFAULT
Supply # Occupied Flow Setpoints (cont.)	Supply # Maximum Flow	<p>The <b>Supply # Maximum Flow</b> sets the maximum supply air flow into the laboratory. The controller will not allow the supply air damper to open further than the <b>Supply # Maximum Flow</b> setpoint.</p> <p><b>NOTE:</b> The laboratory may not hold pressure setpoint when supply air is limited.</p>	0–50,000 CFM (0–15000 LPS) (0–51000 CMH)	<b>0.0 CFM/LPS/CMH</b>
	Supply # Cooling Flow	<p>The <b>Supply # Cooling Flow</b> sets the space cooling supply air flow setpoint. This item defines a supply air flow intended to meet the space’s cooling requirements by allowing the supply flow to increase, gradually, to the <b>Supply # Cooling Flow</b> setpoint, from a minimum ventilation rate, when the space temperature is too warm.</p> <p>If room pressure is not maintained, the general exhaust damper modulates open until pressure setpoint is reached (provided offset is between <b>Minimum Offset</b> and <b>Maximum Offset</b>).</p>	0–50,000 CFM (0–15000 LPS) (0–51000 CMH)	<b>0.0 CFM/LPS/CMH</b>
	Supply # Heating Flow	<p>The <b>Supply # Heating Flow</b> sets the space heating supply air flow setpoint. This item defines a supply air flow intended to meet the space’s heating requirements by allowing the supply flow to increase, gradually, to the <b>Supply # Heating Flow</b> setpoint, from a minimum ventilation rate, when the space temperature is too cool.</p> <p>If room pressure is not maintained, the general exhaust damper modulates open until pressure setpoint is reached (provided offset is between <b>Minimum Offset</b> and <b>Maximum Offset</b>).</p>	0–50,000 CFM (0–15000 LPS) (0–51000 CMH)	<b>0.0 CFM/LPS/CMH</b>

MENU ITEM	SUBMENU NAME	ITEM DESCRIPTION	ITEM RANGE/ OPTIONS	DEFAULT
<b>Supply # Unoccupied Flow Setpoints</b> <i>(cont.)</i>	<b>Supply # Unocc Minimum Flow</b>	<p>The <b>Supply # Minimum Flow</b> sets the minimum supply air flow setpoint. This item provides a minimum supply air flow to meet the ventilation requirement, by preventing the supply flow from going below the preset minimum flow.</p> <p>The controller will not allow the supply air damper to be closed further than the <b>Supply # Ventilation minimum</b> setpoint. If room pressure is not maintained at minimum supply flow, the general exhaust damper modulates open until pressure setpoint is reached (provided offset is between <b>Minimum Offset</b> and <b>Maximum Offset</b>).</p>	0–50,000 CFM (0–15000 LPS) (0–51000 CMH)	<b>0.0 CFM/LPS/CMH</b>
	<b>Supply # Unocc Maximum Flow</b>	<p>The <b>Supply # Unocc Maximum Flow</b> sets the maximum supply air flow into the laboratory when the controller in unoccupied mode. The controller will not allow the supply air damper to open further than the <b>Supply # Unocc Maximum Flow</b> setpoint.</p> <p><b>NOTE:</b> The laboratory may not hold pressure setpoint when supply air is limited.</p>	0–50,000 CFM (0–15000 LPS) (0–51000 CMH)	<b>0.0 CFM/LPS/CMH</b>
	<b>Supply # Unocc Cooling Flow</b>	<p>The <b>Supply # Unocc Cooling Flow</b> sets the space cooling supply air flow setpoint when the space is unoccupied. This item defines a supply air flow intended to meet the space's cooling requirements by allowing the supply flow to increase, gradually, to the <b>Supply # Unocc Cooling Flow</b> setpoint, from a minimum ventilation rate, when the space temperature is too warm.</p> <p>If room pressure is not maintained, the general exhaust damper modulates open until pressure setpoint is reached (provided offset is between <b>Minimum Offset</b> and <b>Maximum Offset</b>).</p>	0–50,000 CFM (0–15000 LPS) (0–51000 CMH)	<b>0.0 CFM/LPS/CMH</b>

MENU ITEM	SUBMENU NAME	ITEM DESCRIPTION	ITEM RANGE/ OPTIONS	DEFAULT
<b>Supply # Unoccupied Flow Setpoints</b> <i>(cont.)</i>	<b>Supply # Unocc Heating Flow</b>	The <b>Supply # Unocc Heating Flow</b> sets the space heating supply air flow setpoint when the space is unoccupied. This item defines a supply air flow intended to meet the space's heating requirements by allowing the supply flow to increase, gradually, to the <b>Supply # Unocc Heating Flow</b> setpoint, from a minimum ventilation rate, when the space temperature is too cool.  If room pressure is not maintained, the general exhaust damper modulates open until pressure setpoint is reached (provided offset is between <b>Minimum Offset</b> and <b>Maximum Offset</b> ).	0–50,000 CFM (0–15000 LPS) (0–51000 CMH)	<b>0.0 CFM/LPS/CMH</b>
<b>Supply # Fixed Setpoints</b>	<b>Supply # Minimum Position</b>	The <b>Supply # Minimum Position</b> sets the minimum position the supply will be allowed.	0–100%	<b>0.0%</b>
	<b>Supply # Maximum Position</b>	The <b>Supply # Maximum Position</b> sets the maximum position the supply will be allowed.	0–100%	<b>100.0%</b>
	<b>Supply # Emergency Flow</b>	The <b>Supply # Emergency Flow</b> sets the flow setpoint the supply will maintain when in Emergency Mode.	0–50,000 CFM (0–15000 LPS) (0–51000 CMH)	<b>0.0 CFM/LPS/CMH</b>
	<b>Supply # Shutdown Flow</b>	The <b>Supply # Shutdown Flow</b> sets the flow setpoint the supply will maintain when in Shutdown Mode.	0–50,000 CFM (0–15000 LPS) (0–51000 CMH)	<b>0.0 CFM/LPS/CMH</b>
<b>Supply # Flow Alarm Setpoints</b>	<b>Supply # Low Flow Alarm</b>	The <b>Supply # Low Flow Alarm</b> sets the low value at which the alarm will sound once the flow goes below.	0–50,000 CFM (0–15000 LPS) (0–51000 CMH)	<b>0.0 CFM/LPS/CMH</b>
	<b>Supply # High Flow Alarm</b>	The <b>Supply # High Flow Alarm</b> sets the high value at which the alarm will sound once the flow goes above.	0–50,000 CFM (0–15000 LPS) (0–51000 CMH)	<b>0.0 CFM/LPS/CMH</b>
	<b>Supply # Unocc Low Flow Alarm</b>	The <b>Supply # Unocc Low Flow Alarm</b> sets the low value, in unoccupied mode, at which the alarm will sound once the flow goes below.	0–50,000 CFM (0–15000 LPS) (0–51000 CMH)	<b>0.0 CFM/LPS/CMH</b>
	<b>Supply # Unocc High Flow Alarm</b>	The <b>Supply # Unocc High Flow Alarm</b> sets the high value, in unoccupied mode, at which the alarm will sound once the flow goes above.	0–50,000 CFM (0–15000 LPS) (0–51000 CMH)	<b>0.0 CFM/LPS/CMH</b>
	<b>Supply # Shutdown Low Flow Alarm</b>	The <b>Supply # Shutdown Low Flow Alarm</b> sets the low value, in shutdown mode, at which the alarm will sound once the flow goes below.	0–50,000 CFM (0–15000 LPS) (0–51000 CMH)	<b>0.0 CFM/LPS/CMH</b>

MENU ITEM	SUBMENU NAME	ITEM DESCRIPTION	ITEM RANGE/ OPTIONS	DEFAULT
Supply # Flow Alarm Setpoints (cont.)	Supply # Shutdown High Flow Alarm	The <b>Supply # Shutdown High Flow Alarm</b> sets the high value, in shutdown mode, at which the alarm will sound once the flow goes above.	0–50,000 CFM (0–15000 LPS) (0–51000 CMH)	<b>0.0 CFM/LPS/CMH</b>

**Exhaust Flow Setpoints Menu**



The **Exhaust Flow Setpoints** menu allows for configuration of the exhaust flow setpoints. Enter the Minimum and Maximum Exhaust Flows per the project. Emergency flow setpoints are used as the flow setpoint to control to in Emergency mode. Flow setpoint alarms are set and activated here.

MENU ITEM	SUBMENU NAME	ITEM DESCRIPTION	ITEM RANGE/ OPTIONS	DEFAULT
<b>Applies to: Exhaust # (1–2)</b>				
<b>Exhaust # Flow Setpoints</b>	<b>Exhaust # Minimum Flow</b>	The <b>Exhaust # Minimum Flow</b> sets the minimum flow the exhaust will be allowed to achieve.	0–40,000 CFM (0–15000 LPS) (0–51000 CMH)	<b>0.0 CFM/LPS/CMH</b>
	<b>Exhaust # Maximum Flow</b>	The <b>Exhaust # Maximum Flow</b> sets the maximum flow the exhaust will be allowed to achieve.	0–40,000 CFM (0–15000 LPS) (0–51000 CMH)	<b>0.0 CFM/LPS/CMH</b>
	<b>Exhaust # Minimum Position</b>	The <b>Exhaust # Minimum Position</b> sets the minimum position the exhaust will be allowed.	0–100%	<b>0.0%</b>
	<b>Exhaust # Maximum Position</b>	The <b>Exhaust # Maximum Position</b> sets the maximum position the exhaust will be allowed.	0–100%	<b>100.0%</b>
	<b>Exhaust # Emergency Flow</b>	The <b>Exhaust # Emergency Flow</b> sets the flow setpoint the Exhaust will maintain when in Emergency Mode.	0–40,000 CFM (0–15000 LPS) (0–51000 CMH)	<b>0.0 CFM/LPS/CMH</b>

## Temperature Setpoints Menu



The **Temperature Setpoints** menu allows for configuration of the temperature setpoints and alarms.

MENU ITEM	SUBMENU NAME	ITEM DESCRIPTION	ITEM RANGE/OPTIONS	DEFAULT
<b>Applies to: Supply # (1–4)</b>				
<b>Supply # Temperature Setpoints</b>	<b>Supply # Heat Setpoint</b>	The <b>Supply # Heat Setpoint</b> is the temperature at which the heating valve is expected to be fully open. The throttling range of the heating valve is the <b>Supply # Cool Setpoint–Supply # Heat Setpoint</b> . <b>NOTE:</b> The difference between <b>Supply # Heat Setpoint</b> and <b>Supply # Cool Setpoint</b> must be between 1°F and 20°F.	50.0°F–85.0°F (10.0°C–30.0°C)	<b>68.0°F</b> <b>(20.0°C)</b>
	<b>Supply # Cool Setpoint</b>	The <b>Supply # Cool Setpoint</b> is the temperature at which the heating valve is expected to be fully closed. The throttling range of the heating valve is the <b>Supply # Cool Setpoint–Supply # Heat Setpoint</b> . <b>NOTE:</b> The difference between <b>Supply # Heat Setpoint</b> and <b>Supply # Cool Setpoint</b> must be between 1°F and 20°F.	50.0°F–85.0°F (10.0°C–30.0°C)	<b>72.0°F</b> <b>(22.0°C)</b>



MENU ITEM	SUBMENU NAME	ITEM DESCRIPTION	ITEM RANGE/OPTIONS	DEFAULT
Supply # Temperature Setpoints <i>(cont.)</i>	Supply # Unocc Heat Setpoint	The <b>Supply # Unocc Heat Setpoint</b> is the temperature at which the heating valve is expected to be fully open, when in unoccupied mode. The throttling range of the heating valve is the <b>Supply # Unocc Cool Setpoint–Supply # Unocc Heat Setpoint</b> .  <b>NOTE:</b> The difference between <b>Supply # Unocc Heat Setpoint</b> and <b>Supply # Unocc Cool Setpoint</b> must be between 1°F and 20°F.	50.0°F–85.0°F (10.0°C–30.0°C)	<b>62.0°F</b> <b>(17.0°C)</b>
	Supply # Unocc Cool Setpoint	The <b>Supply # Unocc Cool Setpoint</b> is the temperature at which the heating valve is expected to be fully closed, when in unoccupied mode. The throttling range of the heating valve is the <b>Supply # Unocc Cool Setpoint–Supply # Unocc Heat Setpoint</b> .  <b>NOTE:</b> The difference between <b>Supply # Unocc Heat Setpoint</b> and <b>Supply # Unocc Cool Setpoint</b> must be between 1°F and 20°F.	50.0°F–85.0°F (10.0°C–30.0°C)	<b>78.0°F</b> <b>(25.0°C)</b>
	Supply # DAT Delta	The <b>Supply # DAT Delta</b> sets the maximum difference between the supply air and room air temperature when heating.	0°F–50°F (0°C–28 C)	<b>20.0°F</b> <b>(11 C)</b>
Supply # Temperature Alarm Setpoints	Supply # Low Temperature Alarm	The <b>Supply # Low Temperature Alarm</b> sets the low value at which the alarm will sound once the temperature goes below.  <b>NOTE:</b> If the temperature setpoint is adjusted by the thermostat, the temperature alarm will adjust the same amount.	50.0°F–85.0°F (10.0°C–30.0°C)	<b>0.0°F</b> <b>(0.0°C)</b>
	Supply # High Temperature Alarm	The <b>Supply # High Temperature Alarm</b> sets the low value at which the alarm will sound once the temperature goes above.  <b>NOTE:</b> If the temperature setpoint is adjusted by the thermostat, the temperature alarm will adjust the same amount.	50.0°F–85.0°F (10.0°C–30.0°C)	<b>0.0°F</b> <b>(0.0°C)</b>

MENU ITEM	SUBMENU NAME	ITEM DESCRIPTION	ITEM RANGE/OPTIONS	DEFAULT
<b>Supply # Temperature Alarm Setpoints</b> <i>(cont.)</i>	<b>Supply # Unocc Low Temperature Alarm</b>	The <b>Supply # Unocc Low Temperature Alarm</b> sets the low value at which the alarm will sound once the temperature goes below, while in unoccupied mode.  <b>NOTE:</b> If the temperature setpoint is adjusted by the thermostat, the temperature alarm will adjust the same amount.	50.0°F–85.0°F (10.0°C–30.0°C)	<b>0.0°F</b> <b>(0.0°C)</b>
	<b>Supply # Unocc High Temperature Alarm</b>	The <b>Supply # Unocc High Temperature Alarm</b> sets the low value at which the alarm will sound once the temperature goes above, while in unoccupied mode.  <b>NOTE:</b> If the temperature setpoint is adjusted by the thermostat, the temperature alarm will adjust the same amount.	50.0°F–85.0°F (10.0°C–30.0°C)	<b>0.0°F</b> <b>(0.0°C)</b>
	<b>Supply # High DAT Alarm</b>	The <b>Supply # High DAT Alarm</b> sets the temperature at which the alarm will sound if the temperature goes above.	50.0°F–150.0°F (28.0°C–83.0°C)	<b>0.0°F</b> <b>(0.0°C)</b>

## Alarm Delays Menu

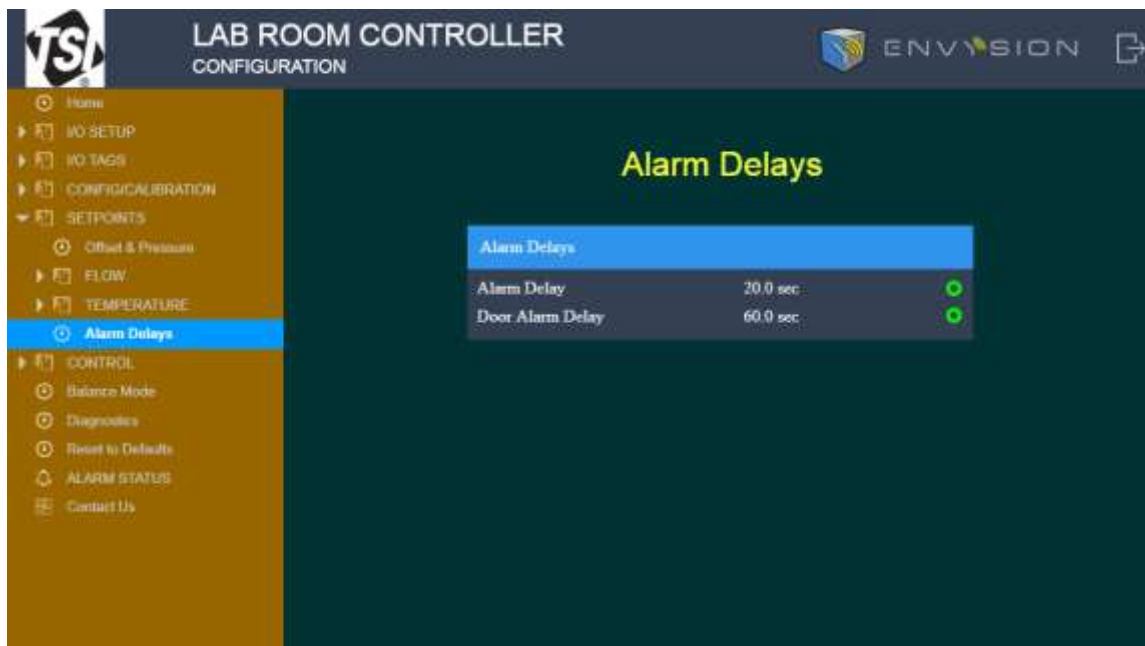

The **Alarm Delays** menu allows for configuration of the delay time before an alarm is triggered.

MENU ITEM	SUBMENU NAME	ITEM DESCRIPTION	ITEM RANGE/OPTIONS	DEFAULT
Alarm Delays	Alarm Delay	The <b>Alarm Delay</b> sets the period of time the room pressure differential, flow or temperature must be above the high alarm setpoint or below the low alarm setpoint before the controller enters alarm mode. Use the <b>Alarm Delay</b> function to avoid momentary, nuisance alarms.	1–600 Sec	<b>20.0 Sec</b>
	Door Alarm Delay	The <b>Door Delay</b> item sets the period of time the room pressure differential, flow or temperature must be above the high alarm setpoint or below the low alarm setpoint before the controller enters alarm mode when the door is open. Use the <b>Door Delay</b> function to avoid momentary, nuisance alarms.	1–600 Sec	<b>60.0 Sec</b>

## Control Menu

### Control Direction Menu



The **Control Direction** menu sets the direction of each flow and temperature control output. Use the slider to configure the control direction.

MENU ITEM	SUBMENU NAME	ITEM DESCRIPTION	ITEM RANGE / OPTIONS	DEFAULT
<b>Applies to: Supply # (1–6), Exhaust # (1–2)</b>				
<b>Supply # Flow Control</b>	N/A	The <b>Supply # Flow Control</b> item determines the control signal's output direction. As an example: if the control system closes the supply damper instead of opening the damper, this option will reverse the control signal to now open the damper.	<ul style="list-style-type: none"> <li>▪ Direct</li> <li>▪ Reverse</li> </ul>	<b>Direct</b>
<b>Supply # Temp Control</b>	N/A	The <b>Supply # Temp Control</b> item determines the control signal's output direction. As an example: if the control system closes the reheat valve instead of opening the damper, this option will reverse the control signal to now open the damper.	<ul style="list-style-type: none"> <li>▪ Direct</li> <li>▪ Reverse</li> </ul>	<b>Direct</b>
<b>Exhaust # Flow Control</b>	N/A	The <b>Exhaust # Flow Control</b> item determines the control signal's output direction. As an example: if the control system closes the exhaust damper instead of opening the damper, this option will reverse the control signal to now open the damper.	<ul style="list-style-type: none"> <li>▪ Direct</li> <li>▪ Reverse</li> </ul>	<b>Direct</b>

## Flow Control Tuning (Supply and Exhaust) Menu



The **Flow Control Tuning** menu allows for changing of the flow control coefficients. Speed and sensitivity are the commonly changed menu items. Changing the Proportional Gain and Integral Time should only be done by persons with thorough knowledge of control loops.

MENU ITEM	SUBMENU NAME	ITEM DESCRIPTION	ITEM RANGE / OPTIONS	DEFAULT
<b>Applies to: Supply # (1–6), Exhaust # (1–2)</b>				
<b>Supply # Control</b>	<b>Supply # Flow Speed</b>	The <b>Supply # Flow Speed</b> effectively modifies the proportional gain and the integral time in fast control mode. If the system is responding too slowly, increase the speed. If the system is responding too quickly and hunting, decrease the speed. <b>NOTE:</b> Adjust the Sensitivity setting before adjusting the Speed.	0–100%	<b>50%</b>
	<b>Supply # Flow Sensitivity</b>	The <b>Supply # Flow Sensitivity</b> item determines when the controller uses slow control and when the controller enters fast control. If the system is over/undershooting from setpoint, decrease the Sensitivity until the system stabilizes. Stability means your flow error stays within the expected range $(100 - \text{Sensitivity}) \times 10^\circ\text{CFM}$ .	0–100%	<b>50%</b>

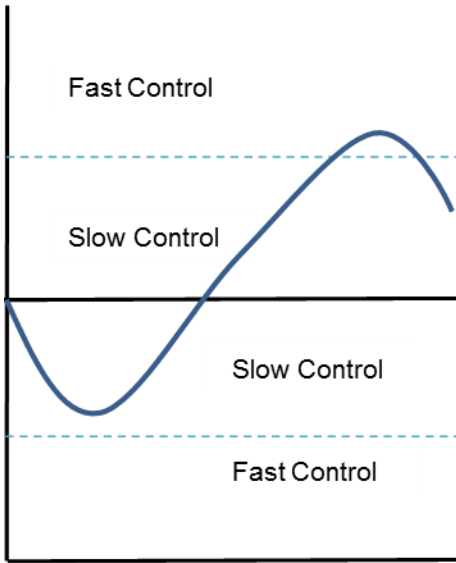
MENU ITEM	SUBMENU NAME	ITEM DESCRIPTION	ITEM RANGE/ OPTIONS	DEFAULT
<b>Supply # Control</b> (cont.)	<b>Supply # Flow Sensitivity</b> (cont.)			
		<p>Each % of <b>Supply # Flow Sensitivity</b> represents 10°CFM that the room pressure must be away from setpoint before the LRC enters fast control (fast control). For example, if the <b>Supply # Flow Sensitivity</b> is set to 80% and the flow setpoint is 1000°CFM, the flow rate must drop below 800°CFM (<math>\text{Setpoint} - (100\% - \text{SENSITIVITY}) \times 10^\circ\text{CFM}</math>) or rise above 1200°CFM (<math>\text{Setpoint} + (100\% - \text{SENSITIVITY}) \times 10^\circ\text{CFM}</math>) for the controller to enter fast control.</p> <div style="border: 1px solid black; padding: 5px; text-align: center; background-color: #f4a460; margin-bottom: 5px;"><b>WARNING</b></div> <div style="border: 1px solid black; padding: 5px;"> <p>Controller may hunt if <b>Supply # Flow Sensitivity</b> is set too high, resulting in poor control and loss of containment.</p> </div> <p>Setting the Sensitivity to 100% will put the controller into slow control only mode. If sensitivity is set to 100%, the room controller will only respond minimally to large flow changes such as a fume hood sash movement.</p>		

MENU ITEM	SUBMENU NAME	ITEM DESCRIPTION	ITEM RANGE/ OPTIONS	DEFAULT
Supply # Control (cont.)	Supply # Flow Proportional Gain	<p>The <b>Supply # Flow Proportional Gain</b> changes the gain control coefficient.</p> <div data-bbox="557 302 1008 352" style="background-color: #f4a460; text-align: center; padding: 2px;"><b>WARNING</b></div> <p>The <b>Proportional Gain</b> and <b>Integral Time</b> items provide the ability to manually change the PI control loop variables. <b>DO NOT CHANGE THESE VALUES UNLESS YOU HAVE A THOROUGH UNDERSTANDING OF PID CONTROL LOOPS. CONTACT TSI® FOR ASSISTANCE PRIOR TO CHANGING ANY VALUES.</b> Incorrectly changing a value will result in poor or non-existent control.</p> <p>Before changing <b>Proportional Gain</b> or <b>Integral Time</b>, change the <b>Speed</b> or adjust the <b>Sensitivity</b> to try to eliminate the problem. If the controller is not controlling correctly (hunting, oscillating, or controlling slowly), the <b>Proportional Gain</b> control coefficient may need adjusting. Decreasing <b>Proportional Gain</b> will slow the control system down making it more stable.</p>	0-1000	80.0

MENU ITEM	SUBMENU NAME	ITEM DESCRIPTION	ITEM RANGE/ OPTIONS	DEFAULT
Supply # Control (cont.)	Supply # Flow Integral Time	The <b>Supply # Flow Integral Time</b> changes the integral control coefficient.	0–1000	200.0
		<div style="border: 1px solid black; padding: 5px; text-align: center; background-color: #f4a460; margin-bottom: 5px;"><b>WARNING</b></div> <p>The <b>Proportional Gain</b> and <b>Integral Time</b> items provide the ability to manually change the PI control loop variables. <b>DO NOT CHANGE THESE VALUES UNLESS YOU HAVE A THOROUGH UNDERSTANDING OF PID CONTROL LOOPS. CONTACT TSI® FOR ASSISTANCE PRIOR TO CHANGING ANY VALUES.</b> Incorrectly changing a value will result in poor or non-existent control.</p> <p>Before changing <b>Proportional Gain</b> or <b>Integral Time</b>, change the <b>Speed</b> or adjust the <b>Sensitivity</b> to try to eliminate the problem. If the controller is not controlling correctly, the unit may have an inappropriate <b>Integral Time</b> control coefficient. Increasing <b>Integral Time</b> will slow the control system down making it more stable.</p>		
Exhaust # Control	Exhaust # Flow Speed	The <b>Exhaust # Flow Speed</b> effectively modifies the proportional gain and the integral time in fast control mode. If the system is responding too slowly, increase the speed. If the system is responding too quickly and hunting, decrease the speed.  <b>NOTE:</b> Adjust the Sensitivity setting before adjusting the Speed.	0–100%	50%
	Exhaust # Flow Sensitivity	The <b>Exhaust # Flow Sensitivity</b> item determines when the controller uses slow control and when the controller enters fast control. If the system is over/undershooting from setpoint, decrease the Sensitivity until the system stabilizes. Stability means your flow error stays within the expected range $(100 - \text{Sensitivity}) \times 10^\circ\text{CFM}$ .	0–100%	50%

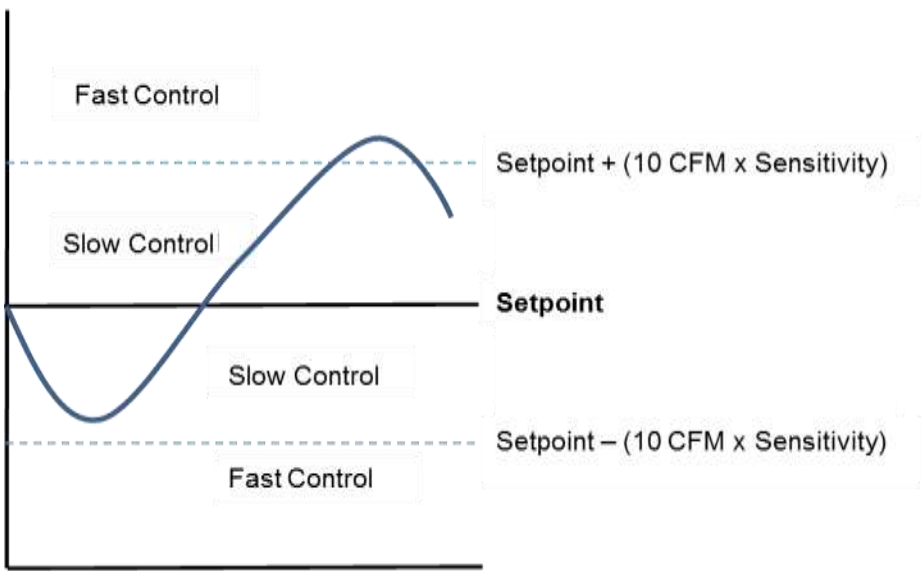

MENU ITEM	SUBMENU NAME	ITEM DESCRIPTION	ITEM RANGE/ OPTIONS	DEFAULT
Exhaust # Control (cont.)	Exhaust # Flow Sensitivity (cont.)	 <p>Each % of <b>Exhaust # Flow Sensitivity</b> represents 1 CFM that the room pressure must be away from setpoint before the LRC enters PID control (fast control). For example, if the <b>Exhaust # Flow Sensitivity</b> is set to 80% and the setpoint is 100°CFM, the room pressure must drop below 80°CFM or rise above 120°CFM for the controller to enter PID control.</p> <div style="border: 1px solid black; padding: 5px; text-align: center; background-color: #f4a460; margin: 10px 0;"><b>WARNING</b></div> <div style="border: 1px solid black; padding: 5px; margin: 10px 0;">Controller may hunt if <b>Supply # Flow Sensitivity</b> is set too high, resulting in poor control and loss of containment.</div> <p>Setting the Sensitivity to 100% will put the controller into slow control only mode. If sensitivity is set to 100%, the room controller will only respond minimally to large flow changes such as a fume hood sash movement.</p>		

MENU ITEM	SUBMENU NAME	ITEM DESCRIPTION	ITEM RANGE/ OPTIONS	DEFAULT
Exhaust # Control (cont.)	Exhaust # Flow Proportional Gain	<p>The Exhaust # Flow Proportional Gain changes the gain control coefficient.</p> <div style="border: 1px solid black; padding: 5px; margin: 5px 0;"> <p style="text-align: center;"><b>WARNING</b></p> <p>The Proportional Gain and Integral Time items provide the ability to manually change the PI control loop variables. <b>DO NOT CHANGE THESE VALUES UNLESS YOU HAVE A THOROUGH UNDERSTANDING OF PID CONTROL LOOPS. CONTACT TSI® FOR ASSISTANCE PRIOR TO CHANGING ANY VALUES.</b> Incorrectly changing a value will result in poor or non-existent control.</p> </div> <p>Before changing Proportional Gain or Integral Time, change the Speed or adjust the Sensitivity to try to eliminate the problem. If the controller is not controlling correctly (hunting, oscillating, or controlling slowly), the Proportional Gain control coefficient may need adjusting. Decreasing Proportional Gain will slow the control system down making it more stable.</p>	0-1000	80.0

MENU ITEM	SUBMENU NAME	ITEM DESCRIPTION	ITEM RANGE / OPTIONS	DEFAULT
Exhaust # Control (cont.)	Exhaust # Flow Integral Time	<p>The <b>Exhaust # Flow Integral Time</b> changes the integral control coefficient.</p> <div style="border: 1px solid black; padding: 5px; margin: 5px 0;"> <p style="text-align: center;"><b>WARNING</b></p> <p>The <b>Proportional Gain</b> and <b>Integral Time</b> items provide the ability to manually change the PI control loop variables. <b>DO NOT CHANGE THESE VALUES UNLESS YOU HAVE A THOROUGH UNDERSTANDING OF PID CONTROL LOOPS. CONTACT TSI® FOR ASSISTANCE PRIOR TO CHANGING ANY VALUES.</b> Incorrectly changing a value will result in poor or non-existent control.</p> </div> <p>Before changing <b>Proportional Gain</b> or <b>Integral Time</b>, change the <b>Speed</b> or adjust the <b>Sensitivity</b> to try to eliminate the problem. If the controller is not controlling correctly, the unit may have an inappropriate <b>Integral Time</b> control coefficient. Increasing <b>Integral Time</b> will slow the control system down making it more stable.</p>	0-1000	200.0

## Pressure Control Tuning Menu



The **Pressure Control Tuning** menu allows for changing of the pressure control coefficient.

MENU ITEM	SUBMENU NAME	ITEM DESCRIPTION	ITEM RANGE / OPTIONS	DEFAULT
<b>Pressure Control Gain</b>	N/A	<p>The <b>Pressure Control Gain</b> changes how quickly the LRC adjusts the offset to achieve the pressure setpoint in adaptive offset control mode.</p> <p>The pressure control loop is very slow when compared to the primary offset control loop. Decreasing <b>Pressure Control Gain</b> will slow the pressure control loop down, while increasing <b>Pressure Control Gain</b> will increase the pressure control loop speed.</p>	0–1000	<b>200</b>

## Temperature Control Tuning Menu



The **Temperature Control Tuning** menu allows for changing of the temperature control coefficients.

MENU ITEM	SUBMENU NAME	ITEM DESCRIPTION	ITEM RANGE / OPTIONS	DEFAULT
<b>Applies to: Supply # (1–6)</b>				
<b>Supply # Control</b>	<b>Supply # Temp Throttling Range</b>	The <b>Supply # Temp Throttling Range</b> determines the throttling range, or number of degrees that the room temperature must change in order to go from full heating to no heating or from full cooling to no cooling.	2.0°F–20.0°F (1°C–12°C)	<b>6.0°F</b> <b>(3.5°C)</b>
	<b>Supply # Temp Integral Time</b>	The <b>Supply # Temp Integral Time</b> determines the integral time of the temperature control loop.	0–10,000 sec	<b>600 sec</b>
	<b>Supply # Reheat/Cooling Delay</b>	The <b>Supply # Reheat/Cooling Delay</b> determines the delay when switching between cooling and heating modes.	1–600 sec	<b>300 sec</b>
	<b>Supply # Flow Change</b>	The <b>Supply # Flow Change</b> sets the setpoint increment when controlling flow to maintain temperature (heating or cooling). If temperature control is too slow, increase the <b>Supply # Flow Change</b> . If temperature control is too fast, decrease the <b>Supply # Flow Change</b> .	1–500 CFM (1–250 LPS, 1–850 CMH)	<b>10 CFM</b> <b>(5 LPS, 5 CMH)</b>

## Balance Mode Menu



**Balance Mode** is used in calibration of air flow. It allows you to take temporary control of specific flows for calibration without changing any of the normal operation settings. To turn on **Balance Mode**, click on the mode slider button to toggle it on. Next, set the specific balancer flow you want to attain, take a reference measurement, and then if necessary, adjust the K factor as needed. To take the controller out of **Balance Mode**, toggle all the slider buttons to off.

### CAUTION

If there are multiple supply/exhaust flows, turn on all the supply/exhaust flows in balancer mode when doing flow verification.

### WARNING

Offset will not be maintained when Balancer mode is turned on.

MENU ITEM	SUBMENU NAME	ITEM DESCRIPTION	ITEM RANGE / OPTIONS	DEFAULT
<b>Applies to: Supply # (1–6), Exhaust # (1–2)</b>				
# Flow Balancer	# Balancer Flow	The # <b>Balance Flow</b> sets the flow value at which you want the controller to achieve.	0–50,000 CFM (0–15000 LPS) (0–51000 CMH)	<b>0.0 CFM/LPS/CMH</b>
	# Flow K Factor	The # <b>Flow K Factor</b> adjusts the flow calibration to match reference measurement (such as from an air balancer). The K-factor is a linear adjustment to the flow measurement. To calculate a new K-Factor, use the formula below.	0.01–2.0	<b>1.0</b>
		$\text{New K Factor} = \frac{(\text{Reference Measurement} \times \text{Starting K Factor})}{\text{Controller Reading}}$		

## Diagnostics Menu



**Diagnostics** displays all the current readings from the controller. This screen allows for viewing all the important readings available on one screen.

Including:

- Room Pressure
- Relative Humidity
- Room Mode
- Occupancy Status
- Switch Status
- Discharge Air Temperatures
- Room Temperature Adjustments
- Supply, Exhaust, and Hood Flows
- Room Temperature Setpoints
- Control modes and current positions for Flow and Temperature
- Manual Position Setpoints for Flows and Temperature
- Firmware Revision Numbers

## Reset to Defaults Menu

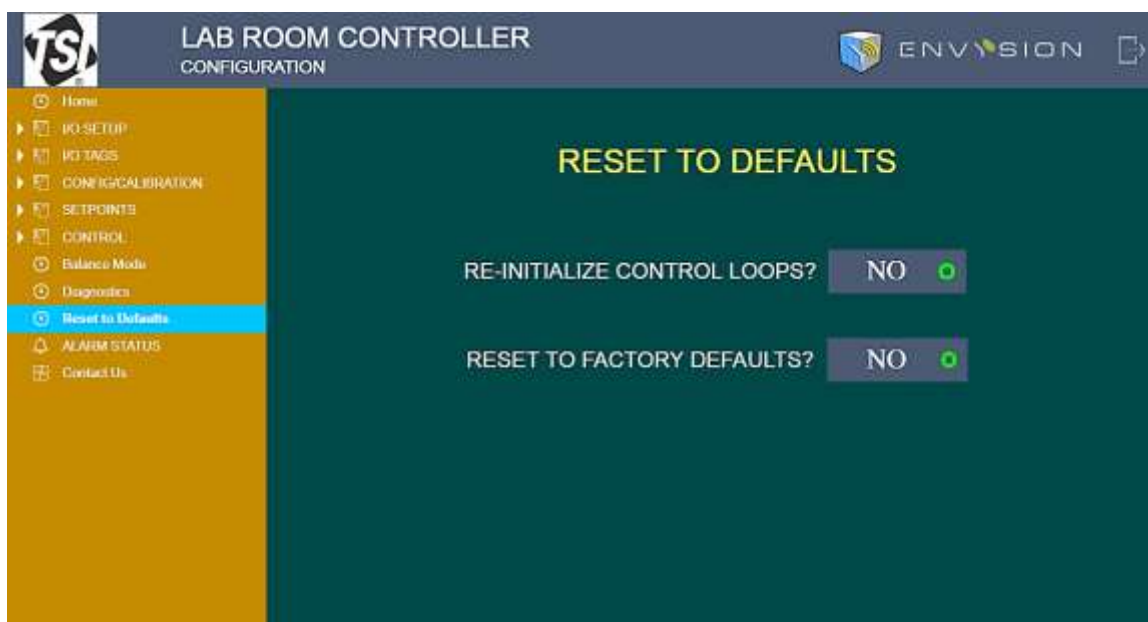

**Reset to Default** allows resetting of the controller back to the original Factory Settings, or just reset the control loops back to defaults.

## Alarm Status Menu



The **Alarm Status** menu displays any current alarms, the alarm description, as well as when they occurred.

## Alarm Constraints

There are a number of constraints that prevent you from incorrectly adjusting the setpoints as follows:

1. The LRC is programmed with deadbands between alarm setpoints and control setpoints to prevent the controller from cycling between high and low alarms due to normal fluctuations. Setpoint deadbands are:
  - Pressure = 0.001.0 in. W.C.
  - Flow = 50°cfm
  - Temperature = 1°F
  - Relative Humidity = 1%
  - Position = 1% Open

**Example:** If the control **NEG SETPNT** is set at -0.01 in. W.C., the **NEG HI ALARM** setpoint cannot be set less negative than -0.011 in. W.C.
2. Alarms **DO NOT** terminate until the room pressure slightly exceeds the alarm setpoint.
3. There is a programmable **Alarm Delay** that determines how long to delay before activating the alarms. This delay affects all alarms, pressure and flow.
4. The low and high alarms are absolute values. The chart below shows how the values must be programmed in order to operate correctly.

-1.0 in. W.C. Min Transducer Reading (maximum negative)		+1.0 in. W.C. Max Transducer Reading (maximum positive)	
High Negative Alarm	Low Negative Alarm	Low Positive Alarm	High Positive Alarm

The value of each setpoint or alarm is unimportant (except for small deadband) in graph above. It is important to understand that the high alarm is a greater negative (positive) value than the low alarm.



## Calibration

This section explains how to calibrate the controller and how to zero a TSI® flow station pressure transducer (optional).

	NOTE
	This section assumes that the appropriate sensor has been correctly installed. Inaccurate readings may be detected if sensor is not installed correctly. Review the Installation Instructions and verify that the sensor is installed correctly (usually only a problem on initial set up).

Reference measurements, from a portable Air Velocity Meter such as TSI®'s VelociCalc® Model 9565 or a capture hood such as the Alnor® Balometer® Model EBT731, are required to calibrate the Laboratory Room Controllers.

	WARNING
	The controller is disabled during calibration. Alarms will not function to warn of unsafe conditions.

To begin the calibration process, enter the appropriate menu. For room pressure, see the [Room Pressure](#) menu. For Supply/Exhaust/Hood Flow, see the [Flows](#) menu.

### Room Pressure Calibration

Room pressure can be measured using either a TSI® through-the-wall sensor or a pressure transducer.

#### TSI® (Through-the-Wall) Sensor Calibration

	NOTE
	The TSI through-the-wall sensor is calibrated at the factory and does not normally need adjustment when installed.

1. Open the door to the laboratory to neutralize the room pressure.
2. Right click on **ROOM PRESSURE CAL MODE, SET VALUE**, and change **VALUE** to **SENSOR ZERO**, and then **APPLY**. This will zero out the sensor.
3. Position a thermal anemometer or other instrument configured to measure air velocity in the door opening to obtain a velocity reading. Take a measurement of the air velocity entering/exiting the door.
4. Change the **VELOCITY K-FACTOR** to make the **SPANNED VELOCITY** match your reference measurement.
5. Right click on **ROOM PRESSURE CAL MODE, SET VALUE**, and change **VALUE** to **SAVE**, and then **APPLY**.

#### Pressure Transducer Zeroing

	NOTE
	If the pressure transducer needs to be calibrated, refer to the instructions that came with the pressure transducer.

1. Select the **PRESSURE TRANSDUCER SIGNAL MINIMUM** item and enter the minimum output signal of the transducer. In this example, you would enter 0 V.
2. Select the **PRESSURE TRANSDUCER SIGNAL MAXIMUM** item and enter the maximum output signal of the transducer. In this example, you would enter 10 V.
3. Select the **PRESSURE TRANSDUCER SENSOR MINIMUM** item and enter the minimum pressure range of the transducer. In this example, you would enter -0.25 in. W.C.

4. Select the **PRESSURE TRANSDUCER SENSOR MAXIMUM** item and enter the maximum pressure range of the transducer. In this example, you would enter +0.25 in. W.C. to zero the pressure transducer:
  - a. Mark the high pressure tubing going to the high port of the transducer.
  - b. Remove the tubing from the high and low ports of the transducer.
  - c. Right click on **ROOM PRESSURE CAL MODE, SET VALUE**, and change **VALUE** to **SENSOR ZERO**, and then **APPLY**. This will zero out the sensor.
  - d. Reconnect tubing to the high and low ports of the pressure transducer, using the mark to connect the high pressure tubing to the high port.

## Flow Calibration

Flow can be measured using a Pressure Flow Station, Linear Flow Station or Venturi with feedback.

### Linear Flow Station Calibration

	<b>NOTE</b>
Flow stations are optional and may not be installed in your system.	

1. Set # **LINEAR DUCT AREA** to the duct area at the linear flow station location.
2. Set # **LINEAR TOP VELOCITY** to match the range of the linear flow station used.
3. Set # **LINEAR SIGNAL MINIMUM** to match the minimum voltage output (0 to 10 V) of the linear flow station used. This is typically 0 V.
4. Set # **LINEAR SIGNAL MAXIMUM** to match the maximum voltage output (0 to 10 V) of the linear flow station used. This is typically 10 V.
5. Adjust the # **LINEAR FLOW K FACTOR**, if needed, to match the flows.

### Pitot Flow Station Calibration with High and Low Calibration Positions

	<b>NOTE</b>
Flow stations are optional and may not be installed in your system.	

1. Set # **PITOT DUCT AREA** to the duct area at the pitot flow station location.
2. Set # **TRANSDUCER SIGNAL MINIMUM** to match the minimum voltage output (0 to 10 V) of the pitot flow station transducer used. This is typically 0 V.
3. Set # **TRANSDUCER SIGNAL MAXIMUM** to match the maximum voltage output (0 to 10 V) of the pitot flow station transducer used. This is typically 10 V.
4. Set # **TRANSDUCER SENSOR MAXIMUM** to match the range of the pitot flow station transducer used.
5. Set # **PITOT LOW CAL POS** to a position that provides the first noticeable increase in voltage from the 0%. A general rule-of-thumb is that the voltage change should occur with the damper approximately 10% to 30% open.
6. Set # **PITOT HIGH CAL POS** to a position that provides the first noticeable increase in voltage from the 0%. Slowly decrease the **HIGH POS** percentage value to adjust the damper position until the **VOLTAGE INPUT** (pressure transducer output) shows the first noticeable decrease in voltage from the 100% position. A general rule-of-thumb is that the voltage change should occur with the damper approximately 70% to 80% open.
7. To Zero the flow station:
  - a. Mark the high pressure tubing going to the high port of the transducer.
  - b. Remove the tubing from the high and low ports of the transducer.

- c. Right-click on **# PITOT CAL MODE, SET VALUE**, and change **VALUE** to **SENSOR ZERO**.
  - d. Reconnect tubing to the high and low ports of the pressure transducer, using the mark to connect to the high port.
8. To calibrate the **LOW FLOW**:
    - a. Right-click on **# PITOT CAL MODE, SET VALUE**, and change **VALUE** to **LOW CAL MODE**.
    - b. Allow the flow to stabilize. Take a reference measurement and enter it for **# LOW CAL FLOW**.
  9. To calibrate the **HIGH FLOW**:
    - a. Right-click on **# PITOT CAL MODE, SET VALUE**, and change **VALUE** to **HIGH CAL MODE**.
    - b. Allow the flow to stabilize. Take a reference measurement and enter it for **# HIGH CAL FLOW**.
  10. Save calibrations by right-clicking on **# PITOT CAL MODE, SET VALUE**, and change **VALUE** to **SAVE**, and then **APPLY**.
  11. Apply a **# FLOW K FACTOR** if needed.

#### Pitot Flow Station Calibration using VAV Box Flow Curve (single-point)

	<b>NOTE</b>
Set Pitot Cal Mode to VAV Box to use the single-point calibration.	

1. VAV Box calibration uses the algorithm  $Flow = K Factor \sqrt{Velocity Pressure}$ .

#### Example:

- Pressure transducer with an output currently indicating 0.5 in wg velocity pressure
- K factor from VAV box manufacturer is 1000

$$Flow = K Factor \sqrt{Velocity Pressure}$$

$$Flow = 1000 \sqrt{0.5}$$

$$Flow = 707 cfm$$

	<b>NOTE</b>
Flow stations are optional and may not be installed in your system.	

2. Set **# FLOW TYPE** to Pitot.
3. Set **# Pitot Cal Mode** to VAV Box.
4. Set **# FLOW K FACTOR** to the top velocity of the VAV Box manufacturer.
5. Set **# TRANSDUCER SIGNAL MINIMUM** to match the minimum voltage output (0 to 10 V) of the pressure transducer used. This is typically 0 V.
6. Set **# TRANSDUCER SIGNAL MAXIMUM** to match the maximum voltage output (0 to 10 V) of the pressure transducer used. This is typically 10 V.
7. Set **# TRANSDUCER SENSOR MAXIMUM** to match the range of the pressure transducer used.
8. To Zero the flow station:
  - a. Mark the high pressure tubing going to the high port of the transducer.
  - b. Remove the tubing from the high and low ports of the transducer.
  - c. Right-click on **# PITOT CAL MODE, SET VALUE**, and change **VALUE** to **SENSOR ZERO**.
  - d. Reconnect tubing to the high and low ports of the pressure transducer, using the mark to connect to the high port.

9. Save calibrations by right-clicking on **# PITOT CAL MODE, SET VALUE**, and change **VALUE** to **VAV BOX**, and then **APPLY**. The result will say Success when saved.
10. Go to Balance Mode menu to verify Calibration and adjust **FLOW K FACTOR** if needed.

	<b>NOTE</b>
	Change Flow K Factor to the top velocity of the box manufacturer.

### Venturi with Feedback Calibration

	<b>NOTE</b>
	LOM Venturi Valves are optional and may not be installed in your system.

1. Obtain the venturi valve minimum and maximum flow, either by reading the label on the venturi valve or by performing duct traverses when the venturi valve is fully closed and fully opened.
2. Set **# VENTURI FLOW MINIMUM FLOW** to the minimum venturi valve flow.
3. Set **# VENTURI FLOW MAXIMUM FLOW** to the maximum venturi valve flow.
4. Adjust the **# VENTURI FLOW K FACTOR**, if needed, to match the flows.

### Door Switch Configuration

	<b>NOTE</b>
	Door switches are optional and may not be installed in your system.

1. Set the **DOOR OPEN SIGNAL** to match the door open indication from the switch. **OPEN** means the switch will open to indicate the door is open. **CLOSED** means the switch will close to indicate the door is open.

### Emergency Switch Configuration

	<b>NOTE</b>
	Emergency switches are optional and may not be installed in your system.

1. Set the **EMERGENCY SIGNAL** to match the emergency signal indication from the switch. Set the signal to correspond with the signal of the sensor.

### Shutdown Switch Configuration

	<b>NOTE</b>
	Shutdown switches are optional and may not be installed in your system.

1. Set the **SHUTDOWN SIGNAL** to match the shutdown signal indication from the switch. Set the signal to correspond with the signal of the sensor.

### Temperature Sensor Configuration

	<b>NOTE</b>
	Temperature sensors are optional and may not be installed in your system.

1. Adjust the **SUPPLY # ROOM TEMP OFFSET** so the displayed temperature matches a reference measurement.

## Relative Humidity Sensor Configuration

	NOTE
	Relative Humidity sensors are optional and may not be installed in your system.

1. Set the **RELATIVE HUMIDITY SIGNAL MINIMUM** to the minimum output voltage of the relative humidity sensor. This is usually 0 V.
2. Set the **RELATIVE HUMIDITY SIGNAL MAXIMUM** to the maximum output voltage of the relative humidity sensor. This is usually 10 V.
3. Set the **RELATIVE HUMIDITY SENSOR MINIMUM** to the minimum reading of the relative humidity sensor. This is usually 0%.
4. Set the **RELATIVE HUMIDITY SENSOR MAXIMUM** to the maximum reading of the relative humidity sensor. This is usually 100%.
5. Adjust the **RELATIVE HUMIDITY OFFSET** so the displayed relative humidity matches a reference measurement.

## Occupancy Sensor Configuration

	NOTE
	Occupancy switches are optional and may not be installed in your system.

1. Set the **OCCUPANCY SIGNAL** to match the occupancy indication from the switch. Set the signal to correspond with the signal of the sensor.

## Discharge Air Temperature Sensor Configuration

	NOTE
	Supply Air Temperature sensors are optional and may not be installed in your system.  Supply air temperature sensors may be part of the room temperature control. However, a room temperature sensor is also required.

1. Set the **SUPPLY # SIGNAL MINIMUM** to the minimum output voltage of the discharge air temperature sensor. This is usually 0 V.
2. Set the **SUPPLY # SIGNAL MAXIMUM** to the maximum output voltage of the discharge air temperature sensor. This is usually 10 V.
3. Set the **SUPPLY # SENSOR MINIMUM** to the minimum reading of the discharge air temperature sensor. This is usually -20 F.
4. Set the **SUPPLY # SENSOR MAXIMUM** to the maximum reading of the discharge air temperature sensor. This is usually 120 F.
5. Adjust the **SUPPLY # DAT OFFSET** so the displayed discharge air temperature matches a reference measurement.

---

## Optimizing Controller Performance

The laboratory room controller uses both integral and PI control methods. Integral control (slower control signal) is used when the controller is near setpoint. Integral control provides stability when natural system fluctuations occur such as duct static pressure variation. PI control (fast control) is used when responding to large disturbances to room pressure differential. PI control rapidly returns the room pressure differential to setpoint, thus assuring containment. Once the controller is in PI control, it continues to control in this mode until the operating setpoint is met.

There are four menu items that change the characteristics of the control output signal;

- 1) SENSITIVITY
- 2) SPEED
- 3) PROPORTIONAL GAIN
- 4) INTEGRAL TIME

TSI recommends only adjusting the **SENSITIVITY** and **SPEED** to fine tune the control signal. Only when the **SPEED** and **SENSITIVITY** items cannot provide a stable system should **Exhaust Proportional Gain Value**, **Supply Proportional Gain Value**, **Exhaust Integral Time Value** and **Supply Integral Time Value** be adjusted. The role of each menu item is covered in the [Menu and Menu Items](#) section of the manual. This section provides some guidance of when a menu item should be changed.

The controller is shipped with PI values that are appropriate for most rooms. If adjustment is needed, minor changes to the **SENSITIVITY** and **SPEED** menu items will yield excellent control. The **SENSITIVITY** item selects when the unit goes into PI control. Each percent of the setting from 100% indicates that the controller must be 1 ft/min away from control setpoint prior to activating PI control. If the **SENSITIVITY** setting is 60% (40% missing), the room pressure (velocity) must be 40 ft/min off setpoint before PI control is activated. Conversely, if the **SENSITIVITY** setting is 80% (20% missing), the room pressure (velocity) must only be 20 ft/min off setpoint before PI control is activated. The default of 80% is usually a good compromise between PID and integral control.

The **SPEED** menu item slows down the control output. The controller is shipped with a control signal capable of rotating the damper 90 degrees in 1.5 seconds. This may be too fast if the damper is in an unstable flow area (very near the exhaust fan), or there are competing air flows at the room. Controllers modulating a VFD system will probably need to be slowed down, since the control signal is substantially faster than the VFD/fan can respond.

The remaining menu items, **Exhaust Proportional Gain**, **Supply Proportional Gain**, **Exhaust Integral Time Value** and **Supply Integral Time Value** should not be adjusted unless severe stability problems exist. Adjusting these variables may improve the response and stability, but the exact opposite may happen causing the controller to become unstable, hunt substantially, or have very slow response. If controller performance cannot be improved by adjusting the **SPEED** and **SENSITIVITY**, the two menu items can be manually set to their default values.

---

## Resetting the Controller

Within the ENVYSION® software is the capability to reset the LRC back to factory default settings in the software. If further actions are needed, there is a blue manual reset button located on the LRC00 module, between the RS-485 and Ethernet ports. See the table below for the button pressing duration and the corresponding action.

Hold Reset For	To
5 seconds	Restart/Reboot the controller.
10 seconds	Reset both Ethernet and Wireless IP address back to factory default settings.
20 seconds	Reset the controller to its factory default settings. User accounts (user names and passwords) will also be reset to the factory default settings and the controller license will be cleared.

## Maintenance and Repair Parts

The Laboratory Room Controller (LRC) requires minimal maintenance. Periodic inspections of system components as well as an occasional pressure sensor cleaning are all that are needed to ensure that the controller is operating properly.

	<b>WARNING</b>
	Turn off power before performing any kind of servicing.

### Regular Maintenance

Each LRC requires minimal maintenance, but it is important to take note of the following:

Clean the outside of the controller by polishing it with a soft dry cloth.

Retighten terminal block connector screws annually to ensure the wires remain securely attached.

### System Component Inspection

It is recommended that the pressure sensor be periodically inspected for accumulation of contaminants. The frequency of these inspections is dependent upon the quality of the air being drawn across the sensor. If the air is dirty, the sensors require more frequent inspection and cleaning.

Visually inspect the pressure sensor by sliding open the sensor housing door (Figure 2). The air flow orifice should be free of obstructions. The small ceramic coated sensors protruding from the orifice wall should be white and free of accumulated debris.

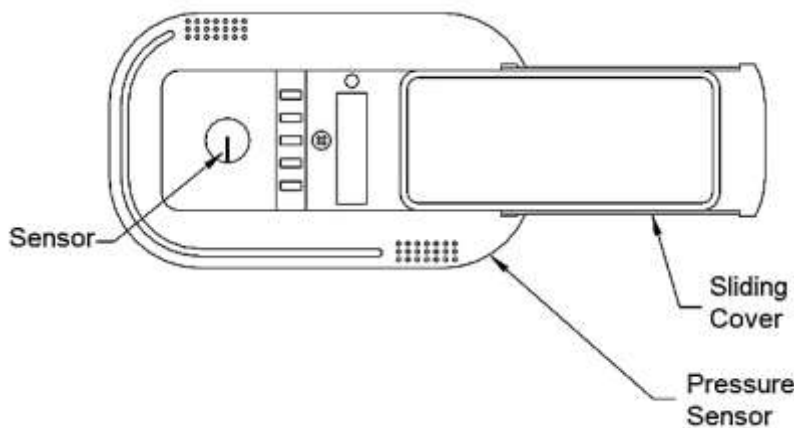

**Figure 2: Pressure Sensor Door Slid Open**

Periodically inspect the other system components for proper performance and physical signs of excessive wear.

### Pressure Sensor Cleaning

Accumulations of dust or dirt can be removed with a dry soft-bristled brush (such as an artist's brush). If necessary, water, alcohol, acetone, or trichlorethane may be used as a solvent to remove other contaminants.

Use extreme care when cleaning the velocity sensors. The ceramic sensor may break if excessive pressure is applied, if sensor is scraped to remove contaminants, or if the cleaning apparatus abruptly impacts the sensor.





## WARNING

If you are using a liquid to clean the sensor, turn off power to the LRC.

**DO NOT** use compressed air to clean the velocity sensors.

**DO NOT** attempt to scrape contaminants from the velocity sensors. The velocity sensors are quite durable; however, scraping may cause mechanical damage and possibly break the sensor. Mechanical damage due to scraping voids the pressure sensor warranty.

### Replacement Parts

All components of the Laboratory Room Control system are field replaceable. Contact TSI® Incorporated or your nearest TSI Manufacturer's Representative for replacement part pricing and delivery.

---

## Troubleshooting Section

The Laboratory Room Controller is designed to be trouble free. However, installation problems or interaction with other HVAC components may cause system problems. The system is easy to troubleshoot if an organized approach to evaluate the system is taken. Troubleshooting is broken down into hardware (mechanical) and software problems. Hardware problems deal with the physical installation of the device. Hardware problems include wiring problems, incorrectly installed equipment, and add-ons or non-TSI® equipment. Software problems include control problems, configuration problems, or interaction problems with the HVAC system.

The hardware test described in this section determines that all TSI® mechanical components are functioning correctly. The hardware test requires the diagnostics menu items to be accessed. If you are unfamiliar with the controller menus, see the [Software Programming](#) section. Troubleshooting the majority of problems is usually quick if the hardware test is followed.

Software and hardware problems are covered in the troubleshooting chart. Pick the problem that most closely resembles your problem and review the possible symptoms and corrective action. Software or system performance problems can and are affected by the supply air system, exhaust air system, or physical configuration of the room. Separating TSI system problems from the laboratory HVAC system can sometimes be difficult. TSI recommends confirming all hardware is operating correctly before troubleshooting software problems.

### Hardware Test

Three tests need to be performed in order to determine all hardware is functioning correctly. The tests are broken down into:

- [Confirming wiring is correct.](#)
- [Confirming physical installation is correct.](#)
- [Verifying mechanical components.](#)

### Confirming Wiring is Correct

The most common problem with installed hardware equipment is incorrect wiring. This problem usually exists on initial installation, or when modifications to the system take place. The wiring should be very closely checked to verify it *exactly* matches the wiring diagram. Wiring diagrams are located in [Appendix D](#) of this manual. Wiring associated with non-TSI components should be closely checked for correct installation. If non-TSI components are installed, consider disconnecting them for testing purposes.

### Confirming Physical Installation is Correct

All of the hardware components need to be installed properly. Review the installation instructions and verify components are installed properly at the correct location. This is easily done when the wiring is checked.



## Verifying Mechanical Components

Verifying all TSI components are operating correctly requires following a simple procedure. The fastest procedure to confirm all equipment is operating is to view the **DIAGNOSTICS** menu to view each component.

	NOTE
	These tests require power to the units, so if unit has no power, refer to hardware troubleshooting chart to eliminate power problem.

## Troubleshooting Chart

Symptom	Possible Cause	Corrective Action
Need to display firmware revision.	--	Enter the <b>DIAGNOSTICS</b> menu.
Measurements in Diagnostics mode always reads zero.	Input is not configured.	Verify the input is appropriately configured.
Controller is not controlling.	Incorrect wiring.	Verify correct wiring (see <a href="#">Wiring diagram</a> ; Appendix D).
	Damper/Valve moving opposite direction.	If damper is full open when it should be closed or full closed when it should be open, go into <b>Control</b> menu and find the specific item. Change <b>DIRECT</b> to <b>REVERSE</b> or <b>REVERSE</b> to <b>DIRECT</b> to change control output direction.
	No control output signal.	Go into <b>DIAGNOSTICS</b> menu, and locate the devices that are related to that output. The controller will show the control outputs as a number between 0% and 100% open. Measure the appropriate control output voltage. The position percentage corresponds to a percentage of the control voltage. For example, 22% of a 0 to 10V signal equates to approximately 2.2 V if direct acting (reverse acting would be 7.8 V).
	Bad actuator or valve (damper or valve linkage does not move).	Go into <b>DIAGNOSTICS</b> menu. The controller will show the supply and exhaust control outputs as a number between 0% and 100%. Note this value. Right click on " <b>Manual Pos.</b> " and change the value to something significantly different than your noted value. For example: If your noted value is 30%, enter a manual value of 60%. Right click on the " <b>Mode</b> " " <b>Auto</b> " and change the value to " <b>Manual</b> ". See the notes below. When troubleshooting is complete, return the " <b>Mode</b> " to " <b>Auto</b> ".  If damper/valve did not move, check that: <ul style="list-style-type: none"> <li>• Damper/valve is not physically stuck (screws, etc.).</li> <li>• Wiring is correct between actuators and controller. Check that voltage varies between 0 and 10 volts on pins 5 and 6 on electric actuator (see <a href="#">No control output signal</a>).</li> <li>• Electric actuator is not over torqued. The electric actuator has current limiting protection. If damper is physically stuck or actuator is over current, the actuator will shut down. To restart either cycle power to actuator or move damper/valve in opposite direction (<a href="#">Control Direction</a> menu item).</li> </ul>

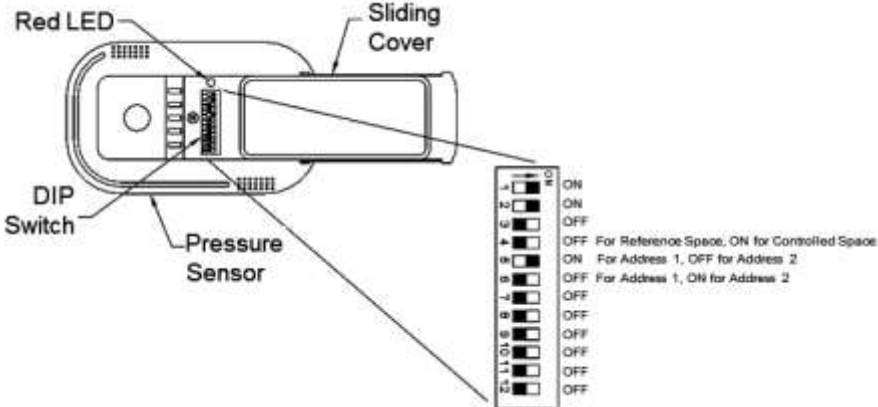
Symptom	Possible Cause	Corrective Action
Controller is not controlling (cont.)	Defective variable frequency drive (VFD).	Perform test described in <a href="#">Control system is not controlling</a> . If Flow Control is functioning, verify wiring to VFD by confirming control output voltage changes at VFD. If voltage changes, a problem with VFD exists. See VFD manual for further troubleshooting.
	Damper/Valve is full open or full closed, will not move.	Control wires are loose. Check wires and verify control output is working (see <a href="#">No control output signal</a> ). If control output test passes, verify damper/valve is moving in correct direction (see <a href="#">Damper/Valve moving opposite direction</a> ). If damper/valve is moving correctly and setpoint cannot be reached, LRC will fully move damper/valve to get as close to setpoint as possible. Exhaust; fan, static pressure, etc. needs to be adjusted.
Sensor reading is opposite sign.	Incorrect pressure sensor mounting location.	Check pressure sensor DIP switch 4 and verify switch is correct (off if the sensor is outside the critical space, on if the sensor is inside the critical space).
 <p style="text-align: center;"><b>Figure 3: Pressure Sensor DIP Switch</b></p>		
Pressure sensor red LED is blinking (Figure 3).	Problem with sensor (slow uniform blink).	Call <a href="#">technical support</a> .
	Communication (fast burst of non-uniform blinking).	Unit is communicating. This is normal.
	Red LED is constantly on or blinks every 5 seconds.	This is normal when no problems exist or when no communication is occurring.
Actuator hunting. Display indicates steady velocity.	Control system is unstable.	Go into <b>CONTROL</b> menu, <b>SUPPLY/EXHAUST CONTROL TUNING</b> menu, <b>SPEED</b> item. Turn speed down until hunting is eliminated. If speed is too slow, adjust accordingly to eliminate problem.

Symptom	Possible Cause	Corrective Action
Displayed room pressure or flow wildly fluctuating.	Supply or Exhaust system unstable.	Go to <b>BALANCE MODE</b> menu, toggle the “ <b>Mode</b> ” for your supply and exhaust to “ <b>Manual</b> ”. This will take manual control of the supply and exhaust control devices. If room pressure stabilizes, supply or exhaust system is not stable. Verify reference pressure is stable.
	Supply air is affecting the sensor.	Check location of supply air diffusers. They should be located as far from the pressure sensor as is realistic, 10 feet preferred with 6 feet minimum. Supply diffuser terminal throw velocity must be less than 10 ft/min at the sensor. Relocate supply or exhaust as needed.
	Controller needs calibration.	Calibrate controller.
Displayed velocity does not match measured velocity.	Pressure sensor is dirty.	See <a href="#">Maintenance and Repair Parts</a> .
	Controller is not calibrated.	See <a href="#">Calibration</a> .
Green LED is not lit on Power Module.	Blow Fuse	Check the fast acting 4 amp inline fuse to verify if it has blown. If it has blown, replace with a fast acting cylinder fuse, 4A, 5 x 20 mm.

*(This page intentionally left blank)*

# Appendix A

## Specifications\*

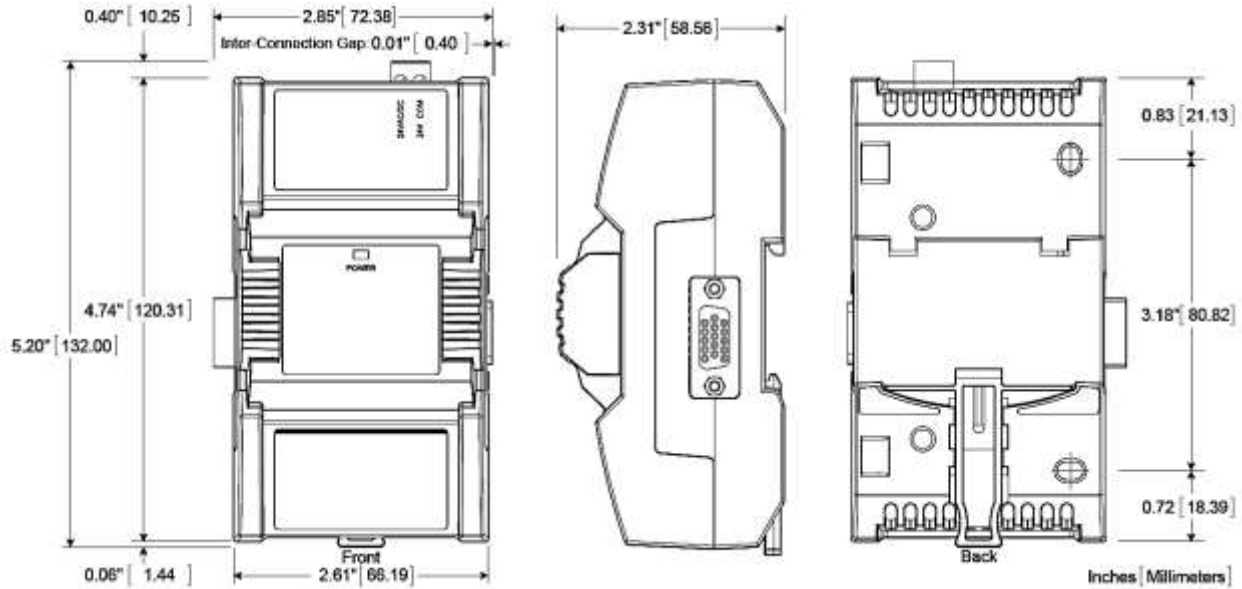

LR-PWR Power Supply Module	
Voltage Range .....	24 VAC/DC: ±15%: Class 2
Power Consumption.....	60 VA
Frequency Range.....	50–60 Hz
Wiring .....	16–16 AWG, shielded
Operating Temperature.....	32 to 122°F (0 to 50°C)
Relative Humidity .....	0 to 90% non-condensing
Output Power .....	18 VDC
Rated Power .....	30W
Dimensions .....	4.74 in x 2.85 in x 2.31 in (120.31 x 72.38 x 58.56 mm)
Weight .....	0.75 lbs (0.34 kg)
Mounting .....	DIN rail or screw mounting
Ingress Protection Rating.....	IP20
NEMA Rating .....	1
Plenum rating .....	UL 1995
Ratings .....	CE EN61000-6-3; A1:2001 CE EN61000-6-1:2007 FCC Part 15, subpart B, class B UL 916 Energy Management Equipment RoHS

\*Specifications are subject to change without notice.

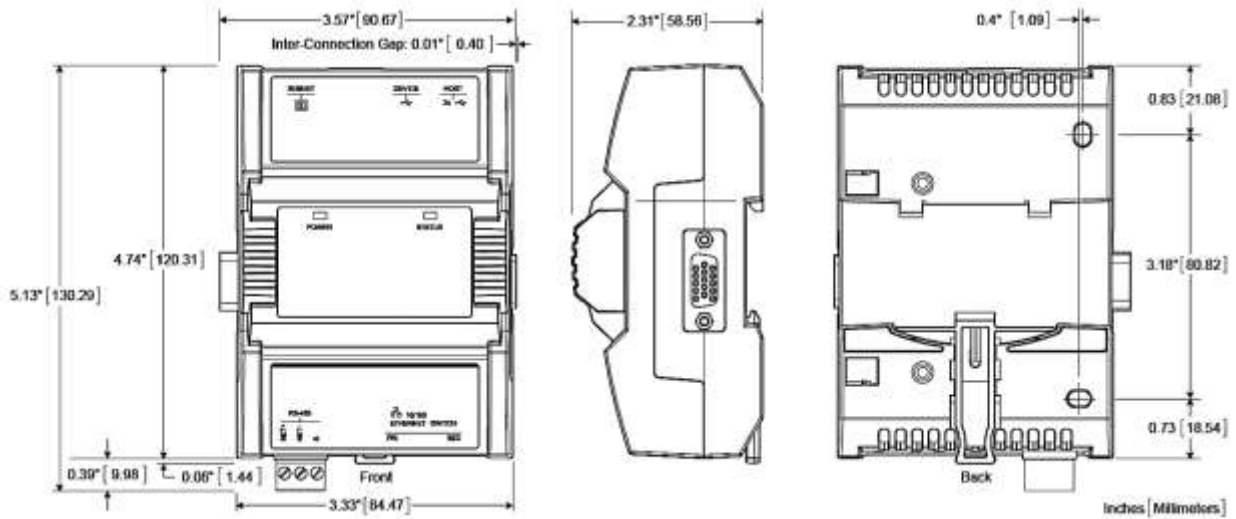

LRC00 Controller Module	
Input Power .....	18 VDC from Power Supply
Power Consumption .....	8.9W
Connections .....	RS485 Wire terminals USB for Wireless adapter RJ-45 Ethernet Port
Wiring Type .....	24AWG, twisted pair, shielded RS485, Daisy Chained
Wireless Adapter .....	LR-Wireless connection port
Ethernet connection .....	CAT5e
Communications Protocols .....	BACnet® MS/TP 76 800, 68 400, 19 200, 9600
Dimensions (D x H) .....	4.74 in x 3.57 in x 2.31 in (120.31 x 90.67 x 58.56mm)
Weight .....	0.85 lbs (0.32 kg)
Mounting .....	DIN rail or screw mounting
Operating Temperature .....	32 to 122°F (0 to 50°C)
Relative Humidity .....	0 to 90% non-condensing
Ingress Protection Rating .....	IP20
NEMA Rating .....	1
Plenum rating .....	UL 1995
Ratings .....	CE EN61000-6-3; A1:2001 CE EN61000-6-1:2007 FCC Part 15, subpart B, class B UL 916 Energy Management Equipment RoHS

\*Specifications are subject to change without notice.

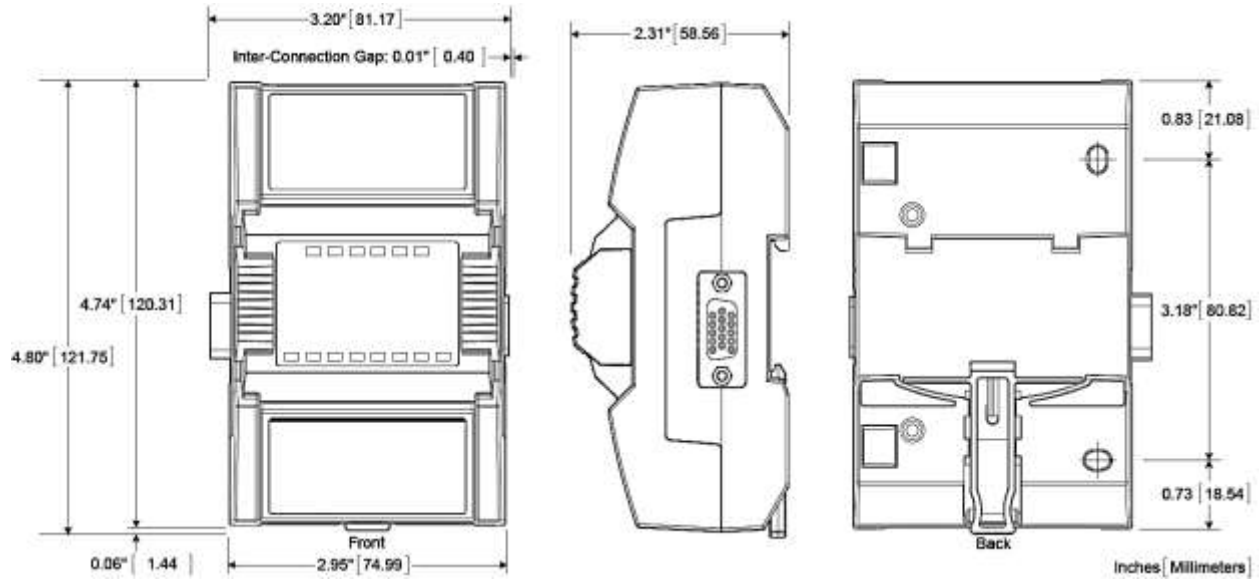

LR-EXP68 or LR-EXP08 Input and Output Modules	
Types of Input .....	0-10 VDC or 1000 Ω RTD
Types of Output.....	0-10 VDC
Input Power .....	18 VDC from Power Supply
Wiring .....	18 AWG, shielded
Dimensions (D x H) .....	4.74 in x 3.20 in x 2.31 in (120.31 x 81.17 x 58.56mm)
Weight .....	0.85 lbs (0.32 kg)
Mounting .....	DIN rail or screw mounting
Operating Temperature.....	32 to 122°F (0 to 50°C)
Relative Humidity .....	0 to 90% non-condensing
Ingress Protection Rating.....	IP20
NEMA Rating .....	1
Plenum rating .....	UL 1995
Ratings .....	CE EN61000-6-3; A1:2001 CE EN61000-6-1:2007 FCC Part 15, subpart B, class B UL 916 Energy Management Equipment RoHS

\*Specifications are subject to change without notice.

*(This page intentionally left blank)*



# Appendix B

## Mounting Information

The Laboratory Room Controller can be mounted to DIN rail, or directly to another material.

Each module can be mounted on a DIN rail for fast installation and easy maintenance. Each module also has two pre-molded mounting holes allowing the module to be mounted in a panel or on a wall.

Ensure that the mounting surface can support the controller, DIN rail, and any site-supplied enclosure.

1. Select the mounting location of the Laboratory Room Controller (LRC). The construction plans normally show the mounting location. If no location is specified then the unit is typically installed above the ceiling in the laboratory next to the main entrance. Mounting inside a proper electrical enclosure is recommended.

<b>WARNING</b>	
	<p>If the LRC is mounted in a box, be sure to maintain proper clearances for access and wiring knockouts.</p> <p><b>DO NOT</b> install if any other equipment will interfere with opening the door.</p> <p><b>DO NOT</b> block the wiring knockouts on the side of the box.</p> <p><b>DO NOT</b> drill in panel after LRC has been mounted.</p>

2. Remove the products from the box and set in a safe location.
3. Set the pieces in the correct mounting order (Figure 5) and position (Figure 6).

## Mounting Positions

The controller's mounting orientation must be horizontal with controllers back attached to a vertical wall surface.

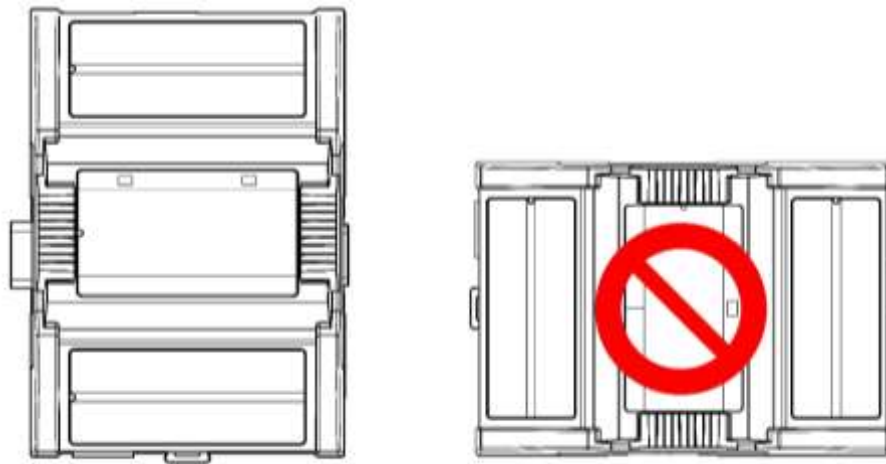

Horizontal Mounting Position	Vertical Mounting Position
Required for DIN rail mounting Required for wall mounting	Is forbidden

Figure 4: Horizontal and Vertical Mounting Positions

## Assembly Order

Modules are connected in a left to right order, starting with the LR-PWR, the LRC00, followed by LR-EXP68 module(s), and then finally the LR-EXP08 module(s).

On the top panel of each module there are roman numerals to aid in maintaining proper installation order. One line (LR-PWR) signifies this to be the first module on the left. Two lines (LRC00) denote the second module from the left. Three lines (LR-EXP68) will be the third module from the left.



Figure 5: Module Top Panel Labels Denoting Assembly Order

For more than one LR-EXP68 module, both LR-EXP68 modules will still be right of the LRC00 Module, but to the left of any LR-EXP08 Module (if applicable), which has no lines on the upper panel.

Be sure to keep all modules in one straight line orientation. If installation in one straight line is not possible, please see the [Multiple Row Configuration](#) section for more information.

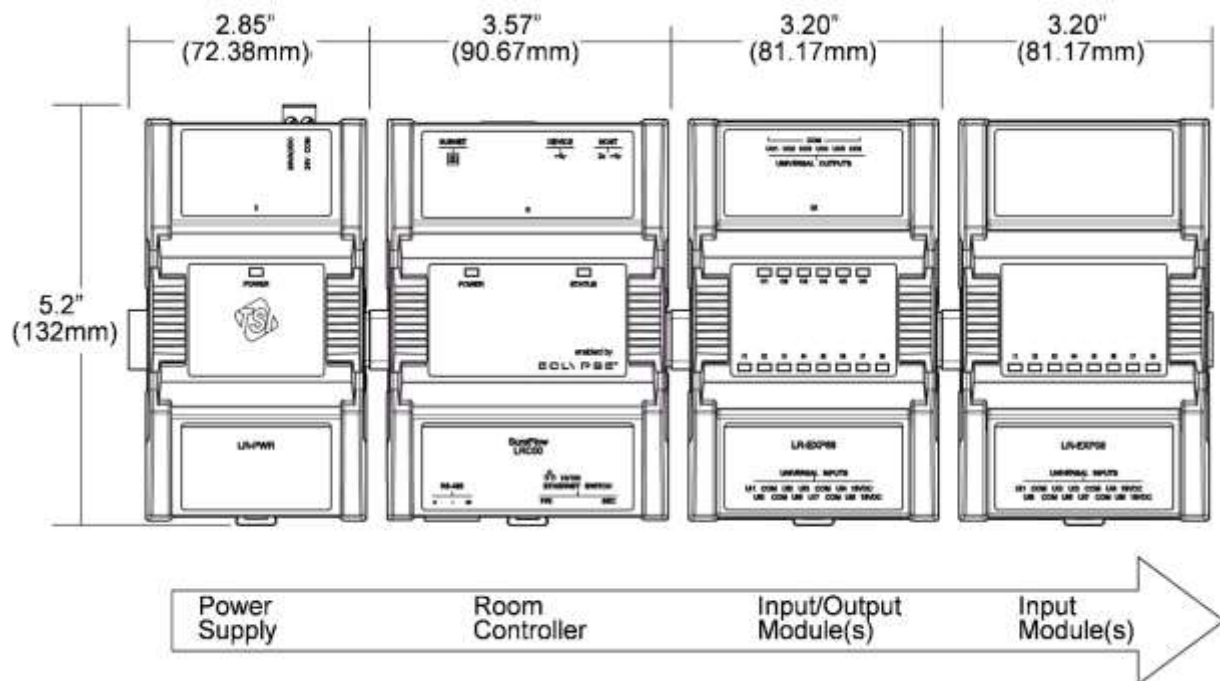

Figure 6: Assembly Order

Select the appropriate mounting method (DIN rail, or other) and follow instructions below.

---

## DIN Rail-Mounted Installation

1. Securely mount the DIN rail horizontally on the wall.
2. Clip the modules onto the DIN rail in the assembly order (see [above](#)).
3. Slide the modules together so that the side connectors of each module are firmly mated with the adjoining module. Use DIN rail clips to keep the row of modules well secured together and to prevent the movement of any module along the DIN rail. Certain modules come with DIN rail clips in the box.
4. To detach the module from the DIN rail, separate the module from any other module located on either side. Use a flat screw driver to pull down on the release clip located at the bottom center of the module and pull it off the DIN rail, bottom first.

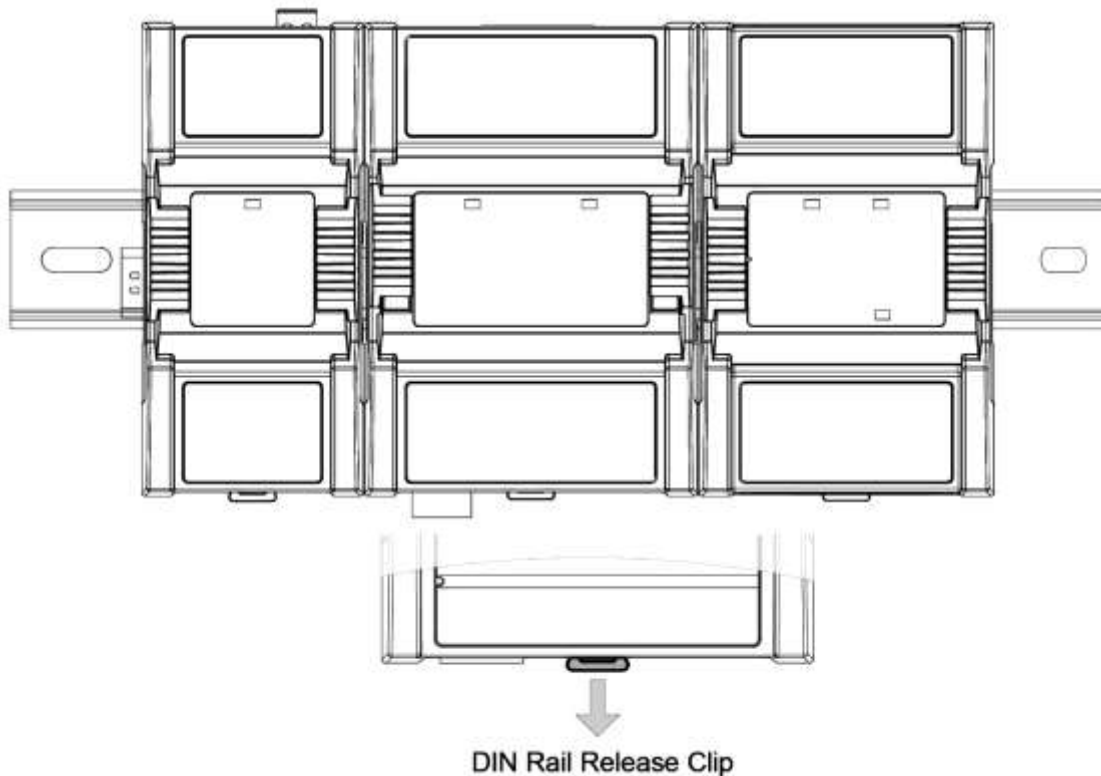

Figure 7: DIN Rail-Mounted Installation

---

## Wall-Mounted Installation

1. Modules should be mounted on a wall one module at a time.
2. Before mounting a module, separate the front assembly from the back plate of each module to be mounted: push the two latches up to unlock a module's front assembly as shown below.

**For LRC-PWR or LRC00 modules:** Separate the front and back base by gently pulling the front assembly off of the back base, thereby separating the electrical connectors between the two halves (Figure 8).

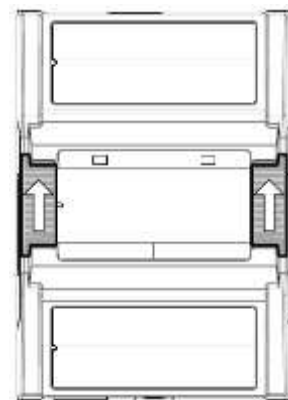
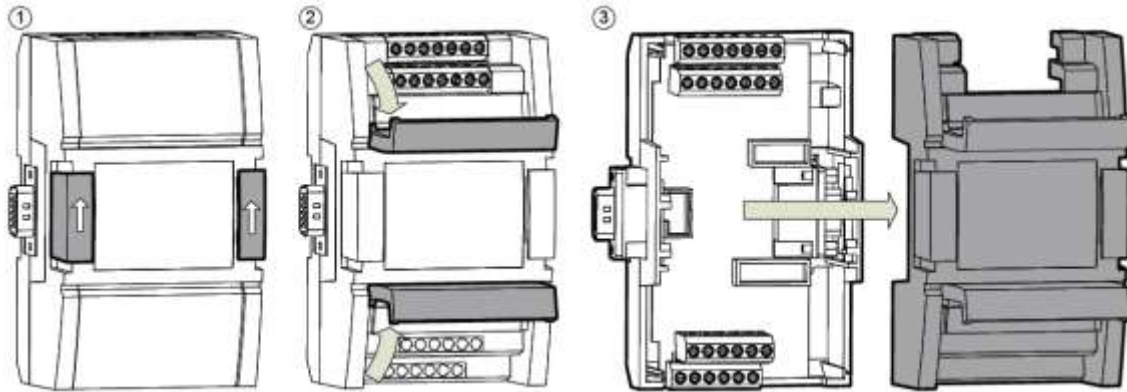

Figure 8: LRC-PWR or LRC00 Modules

**For LR-EXP68 or LR-EXP08 modules:** Separate the front and back base by opening and pulling the hinged gull-wing covers, thereby separating the electrical connectors between the two halves.



**Figure 9: LR-EXP68 or LR-EXP08 modules**

3. Once the front assembly has been removed, use the back plate's mounting holes to mark the location of any holes that need to be drilled as shown in Figure 10.
4. Use the mounting holes to mark the location of any holes that need to be drilled.
5. Drill the holes. **DO NOT** attempt to drill through the back plate.
6. Clean the surface.
7. Mount the module using a No. 8 slotted hex, size: 1/4" or equivalent mounting hardware appropriate to the wall material type.
8. To lock a module's front assembly in place, attach the front assembly to the module's back base by closing any gull-wing front assemblies (if applicable) and pushing the two latches down.
9. Once this module has been attached to the wall, connect the next module on the right so that the side connectors are firmly coupled and the modules are aligned straight.
10. Now attach this module to the wall.
11. Repeat until all modules are mounted in a row.

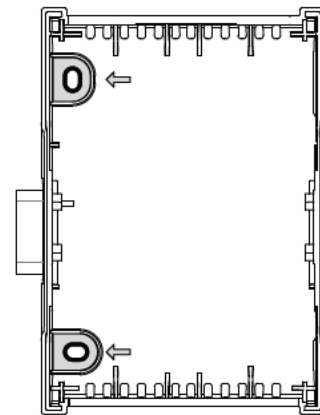

**Figure 10: Back plate's Mounting Holes**

## Dimensions

Exact dimensions of the LRC will vary depending on the exact modules. Use the chart below for LRC dimensions. Allow the appropriate space to allow for wiring and accessibility clearance.

Model Number	Dimensions (LWD)
LRC-BASE-xxx (includes LC-PWR, LRC00, LC-EXP68)	9.7 in. x 5.2 in. x 2.4 in. (245 mm x 132 mm x 61 mm)
LRC-BASE-xxx + (1) LC-EXP68	12.9 in. x 5.2 in. x 2.4 in. (326 mm x 132 mm x 61 mm)
LRC-BASE-xxx + (1) LC-EXP08	12.9 in. x 5.2 in. x 2.4 in. (326 mm x 132 mm x 61 mm)
LRC-BASE-xxx + (1) LC-EXP68 + (1) LC-EXP08	16.1 in. x 5.2 in. x 2.4 in. (407 mm x 132 mm x 61 mm)
LRC-BASE-xxx + (2) LC-EXP08	16.1 in. x 5.2 in. x 2.4 in. (407 mm x 132 mm x 61 mm)
LRC-BASE-xxx + (1) LC-EXP68 + (2) LC-EXP08	19.3 in. x 5.2 in. x 2.4 in. (488 mm x 132 mm x 61 mm)

Figure 11: LRC Dimensions

*(This page intentionally left blank)*

## Multiple Row Configuration

Some applications may require the Laboratory Room Controller (LRC) to be mounted in multiple rows. Be sure to follow the same [assembly order directions](#), but each new row will require an additional LR-PWR module to begin the left side of each row. The second LR-PWR will require a secondary 24V power source. The LR-CABLE will connect the furthest right module from the row above, to the left-most module (LR-PWR) at the beginning of the next row. See Figure 12 for information.

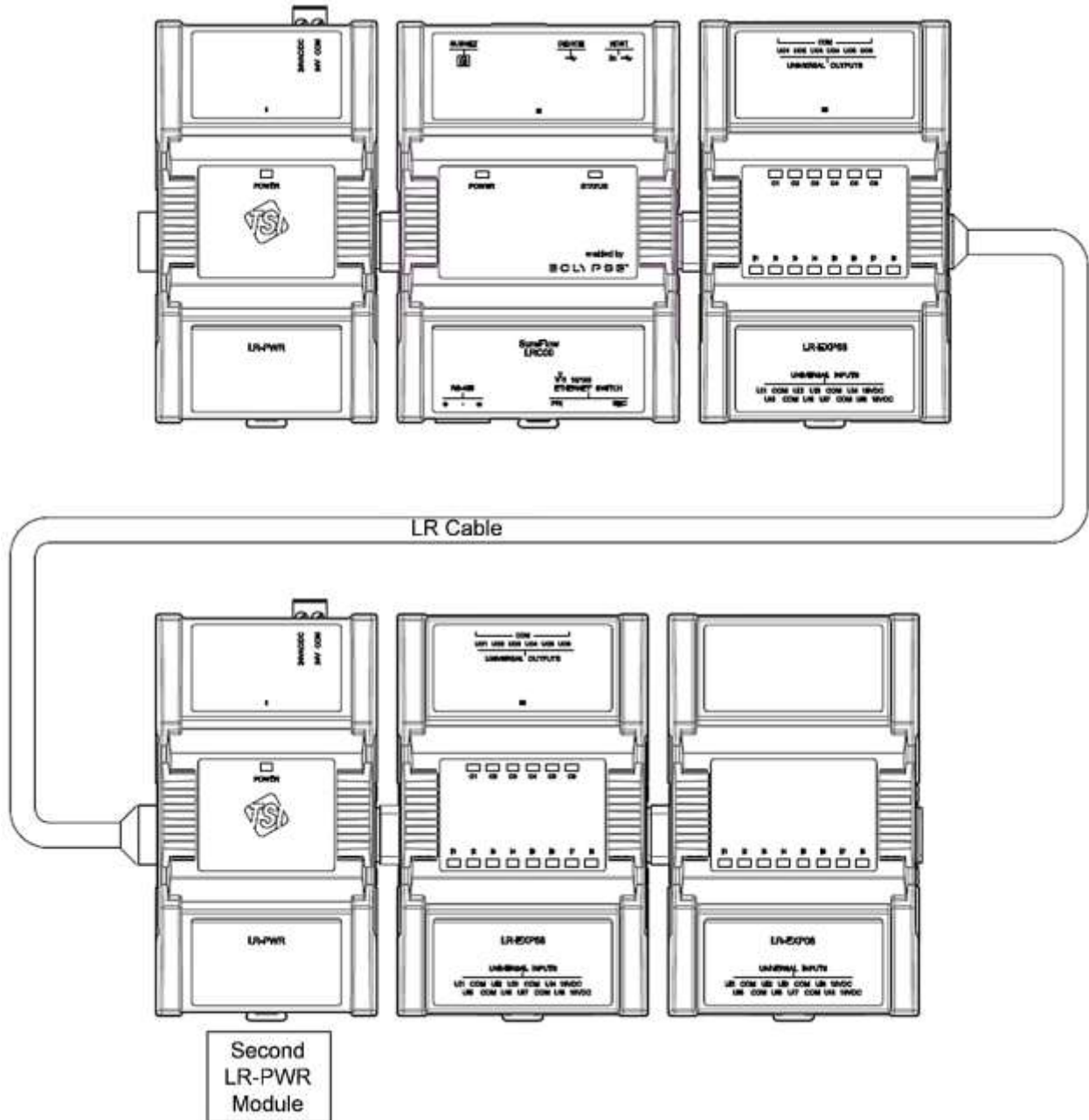



Figure 12: Typical Multiple Row Configuration

*(This page intentionally left blank)*



## Wiring Information

### General Wiring Recommendations

<b>WARNINGS</b>	
	<ul style="list-style-type: none"><li>• <b>Risk of Electric Shock:</b> Turn off power before any kind of servicing to avoid electric shock. However, it is not necessary to remove power when hot-swapping module front assemblies.</li><li>• <b>DO NOT</b> connect more than 24 VAC to any terminal.</li><li>• <b>DO NOT</b> apply voltage to the RS-485 output, analog output, or control output. Severe damage may occur to the unit if voltage is applied and will violate the warranty.</li></ul>

- Refer to [Communications Wiring](#) section for specific details about RS-485 or Ethernet wiring requirements.
- All wiring **must** comply with electrical wiring diagrams as well as national and local electrical codes.
- To connect the wiring to a device, use the terminal connectors. Use a small flat screwdriver to tighten the terminal connector screws once the wires have been inserted (strip length: 0.25" (6 mm), tightening torque 0.5 nm). Keep wires separate according to their function and purpose to avoid any ambient noise transmission to other wires. Use strapping to keep these wires separated. For example, keep power, hazardous voltage, network, and input wiring separate from each other.
- **DO NOT** connect the universal inputs, analog/digital outputs or common terminals to earth or chassis ground. The controller must be 24V floating common.
- Keep input and output wiring in conduits, trays or close to the building frame if possible.

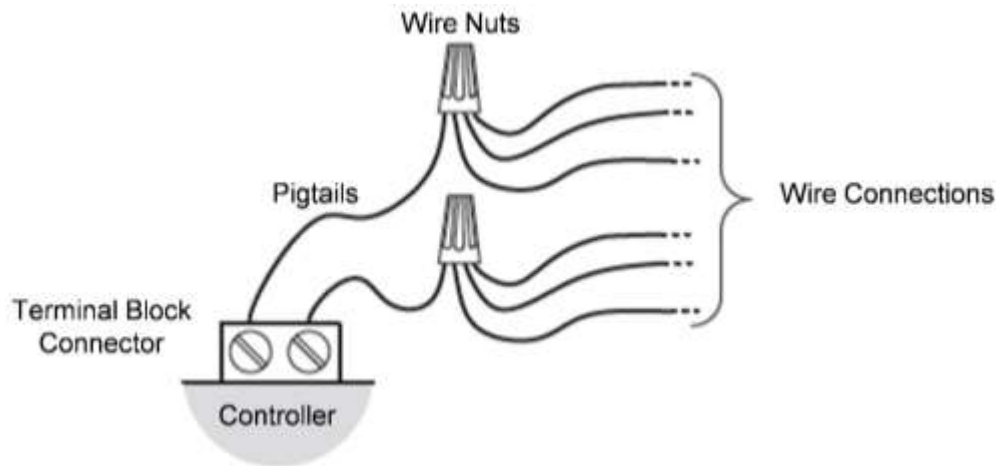

Figure 13: Controller's Terminal Block Connection

## LR-PWR Module Wiring

A transformer rated at 50 VA minimum must be used for each power supply for it to operate at full capacity. Each LR-PWR draws 30W.

Use an external fuse on the 24 VAC side (secondary side) of the transformer, as shown in the figure, to protect all modules against power line spikes and mis-wiring.

Each power supply can support the base model (LR-PWR, LRC00, LR-EXP68) and (1) additional LR-EXP68 and (2) LR-EXP08 modules mounted on a single DIN rail. If multiple DIN rails are used, each rail requires its own LR-PWR power supply. See [Multiple Row Configuration](#) section for more information.

No modules should be connected to the left side of the LR-PWR module.

Maintain consistent polarity when connecting controllers and devices to the transformer. Ensure proper grounding per local codes.

### Wire sizing:

- Single wire into the terminal block: 14–18 gauge.

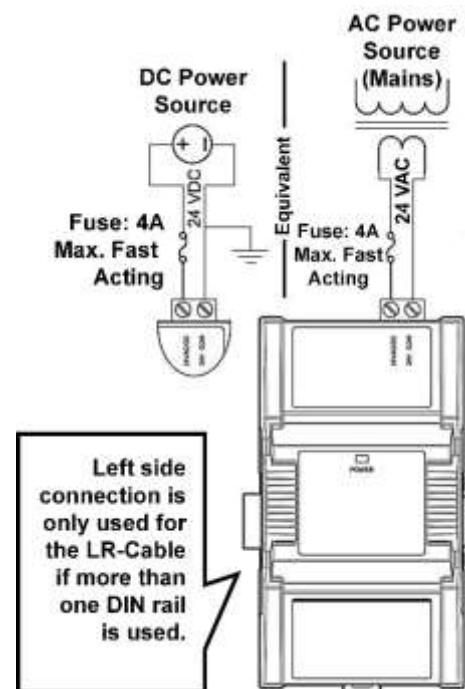

Figure 14: LR-PWR Module Wiring

## LR-EXP68 and LR-EXP08 Input Wiring

For terminal block connector wiring best practices, see [General Wiring Recommendations](#). Inputs can be connected as follows.

### Wire sizing:

- Single wire into the terminal block: 16–22 gauge.
- Two wires into the terminal block: 18–22 gauge, same size, and same type (solid or stranded). Twist wire ends together.
- For any other wiring combinations, including mixed wire thickness, mixed wire type, or more than two wires, refer to the terminal block connection in Figure 13.

<b>0–10 VDC Input</b> (2 wire)	
<b>1000Ω Platinum RTD Input</b>	
<b>Dry Contact Input</b>	

## LR-EXP68 Output Wiring

For terminal block connector wiring best practices, see [General Wiring Recommendations](#). Outputs can be connected as follows.

### Wire sizing:

- Single wire into the terminal block: 16-22 gauge.
- Two wires into the terminal block: 18-22 gauge, same size, and same type (solid or stranded). Twist wire ends together.
- For any other wiring combinations, including mixed wire thickness, mixed wire type, or more than two wires, refer to the terminal block connection in Figure 13.

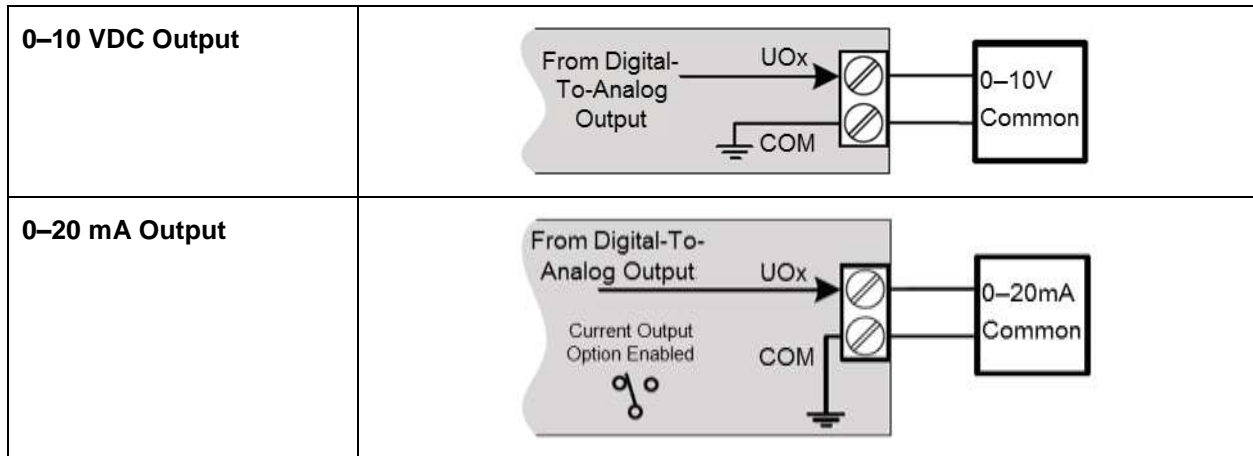

# Communications Wiring

## BACnet IP

BACnet® IP utilizes Ethernet cabling to achieve higher data transfer rates. Be sure to use unshielded CAT5e (or better) cables for Ethernet communications.

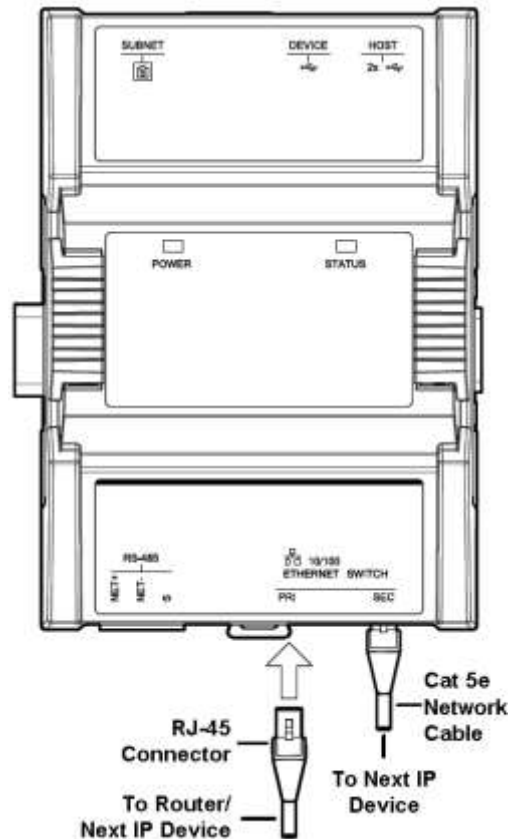

Figure 15: Typical BACnet® IP Wiring

For BACnet® IP communication wiring, be sure to comply with the following:

Parameter	Details
Media.....	Cat 5e Cable; four (4) pairs of wires with RJ-45 Connectors (standard straight patch cable)
RJ-45 Pin Configuration .....	Straight-through wiring. Crimp connectors as per T568A or T568B (both cables ends must be crimped the same way)
Characteristic impedance.....	100–130 Ohms
Distributed capacitance .....	Less than 100 pF per meter (30 pF per foot)
Maximum Cat 5e cable length between IP devices .....	328 feet (100 m) maximum
Polarity .....	Polarity sensitive
Multi-drop .....	Daisy-chain (no T-connections) Devices have two RJ-45 female RJ-45 connectors that provide IP packet switching to support follow-on devices.
Daisy-chain limit, Connected System Controllers.....	Up to 20 devices can be daisy-chained per network switch port.
EOL terminators .....	Not applicable
Shield Grounding .....	Not applicable

## BACnet MS/TP

For BACnet® MS/TP communication wiring, be sure to comply with the standard RS-485 wiring practices. If the LRC is the end of the communication trunk, end of line resistors are needed. End of line resistors are incorporated within the LRC00, and are defaulted to “off.” If this is the first or last device on the communication trunk, turn on the end of line resistors by removing the communications module cover and flip the DIP switches to “on” as shown in Figure 16.

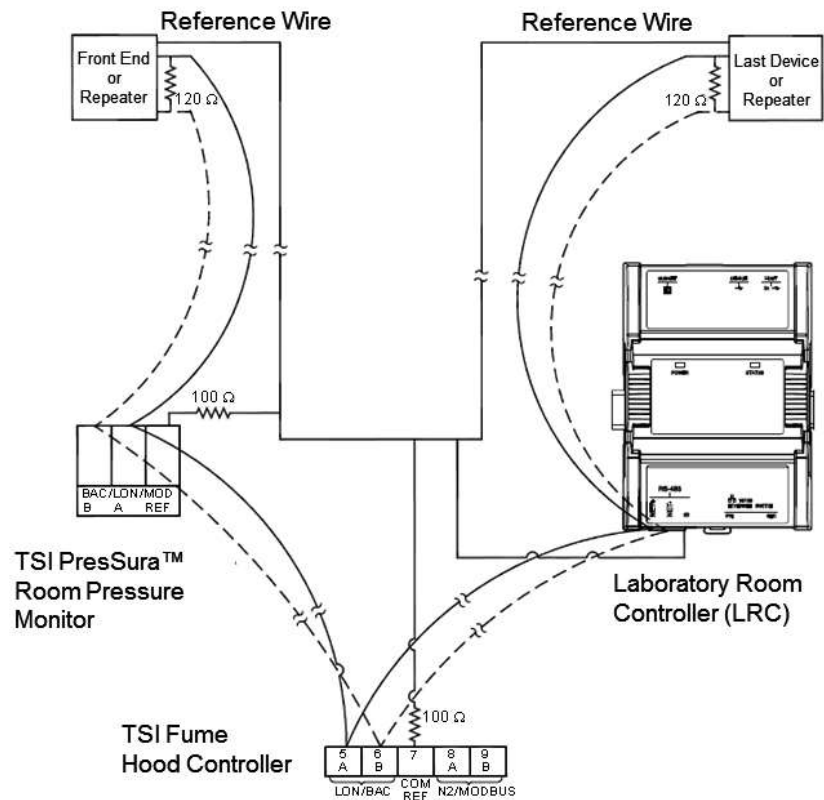

Figure 16: Typical RS-485 Wiring Diagram for TSI Devices

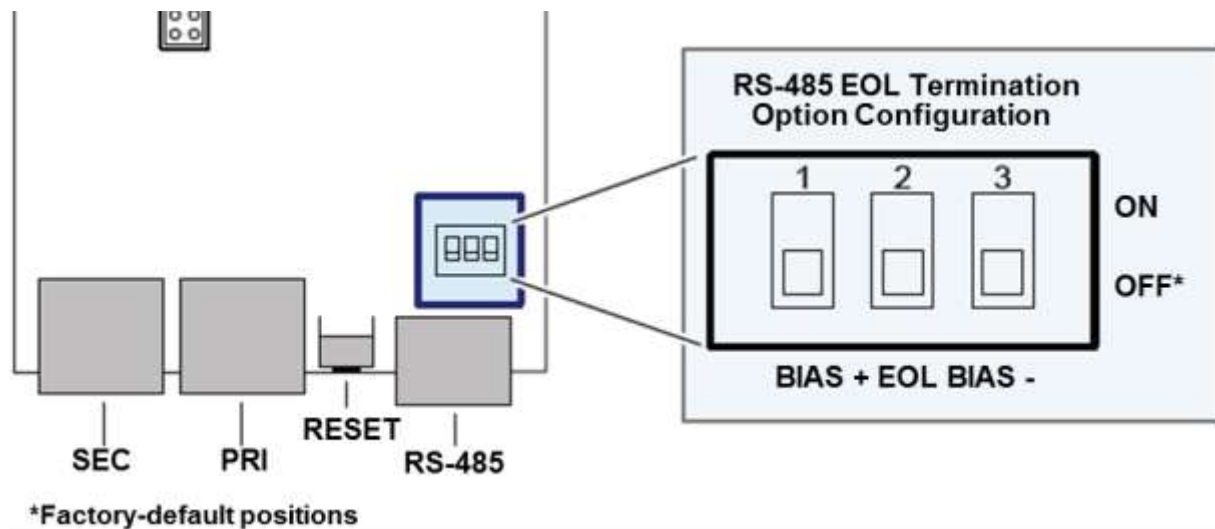

Figure 17: RS-485 End of Line Resistor DIP Switches

For BACnet® MS/TP communication wiring, be sure to comply with the following:

Parameter	Details
Media.....	Twisted, 24 AWG
Shielding .....	Foil or braided shield
Shield Grounding .....	The shield on each segment is connected to the electrical system ground at one point only.
Characteristic impedance.....	100–130 ohms. The ideal is 100–120 ohms.
Distributed capacitance between conductors .....	Less than 100 pF per meter (30 pF per foot). The ideal is less than 60 pF per meter (18 pF per foot).
Distributed capacitance between conducted and shield .....	Less than 200 pF per meter (60 pF per foot).
Maximum length per segment....	1220 meters (4000 feet)
Data rate .....	9600, 19 200, 38 400, and 76 800 baud
Polarity .....	Polarity sensitive
Multi-Drop.....	Daisy-chain (no T-connections)
EOL terminations .....	120 ohms at each end of each segment
Data bus bias resistors.....	510 ohms per wire (max. of two sets per segment)

# Appendix E

## Wiring Connection Information

NOTE
See project submittals for wiring diagrams.

### LR-PWR Power Supply Wiring

Pin Name	Connection Type	Signal	Description
24 VAC/DC	Input	24 VAC/DC	Power wiring from transformer
24 V COM	Input	24 V Common	Power wiring from transformer

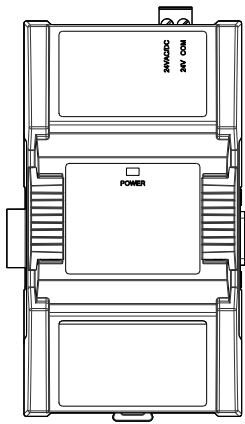

### LRC00 Controller Module

Pin Name	Connection Type	Signal	Description
SUBNET	Not Used	Not Used	Not Used
DEVICE	Not Used	Not Used	Not Used
HOST	USB	USB	Used for Wireless connection
RS-485	Communication	RS-485 (+, -, Reference)	BACnet® communication
Reset Blue Button	None	Push Button	See Installation and Operators Manual for more information.
ETHERNET SWITCH (PRI)	Ethernet	RJ-45	From Router/Next IP Device
ETHERNET SWITCH (SEC)	Ethernet	RJ-45	To next BACnet® IP Device

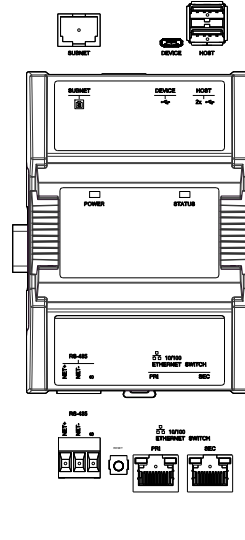

All connectors are located under gull-wing covers

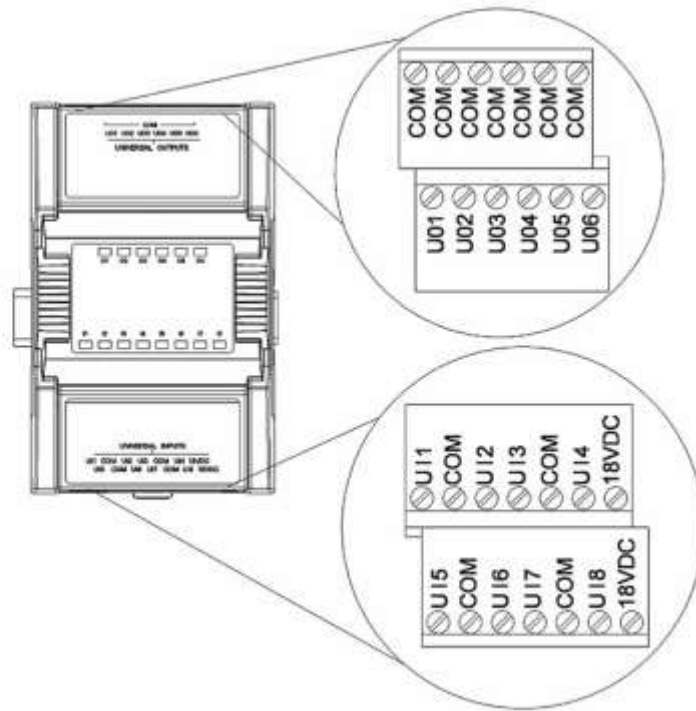

Figure 18: LR-EXP68 I/O Module

**NOTE**

COM on the input side is a shared common to be used by the surrounding inputs. COM for the output side has a dedicated common.

Pin Name	Connection Type	Signal Type	Description
UO1	Output	0–10 VDC or 0–20 mA	Output 1 (Configurable)
UO2	Output	0–10 VDC or 0–20 mA	Output 2 (Configurable)
UO3	Output	0–10 VDC or 0–20 mA	Output 3 (Configurable)
UO4	Output	0–10 VDC or 0–20 mA	Output 4 (Configurable)
UO5	Output	0–10 VDC or 0–20 mA	Output 5 (Configurable)
UO6	Output	0–10 VDC or 0–20 mA	Output 6 (Configurable)
COM	Common	0–10 VDC or 0–20 mA	Electrical Common
UI1	Input	0–10 VDC or 1000Ω RTD or Switch	Input 1 (Configurable)
COM	Common	0–10 VDC or 1000Ω RTD or Switch	Electrical Common
UI2	Input	0–10 VDC or 1000Ω RTD or Switch	Input 2 (Configurable)
UI3	Input	0–10 VDC or 1000Ω RTD or Switch	Input 3 (Configurable)
COM	Common	0–10 VDC or 1000Ω RTD or Switch	Electrical Common
UI4	Input	0–10 VDC or 1000Ω RTD or Switch	Input 4 (Configurable)
18VDC	Not Used	Not Used	Not Used
UI5	Input	0–10 VDC or 1000Ω RTD or Switch	Input 5 (Configurable)
COM	Common	0–10 VDC or 1000Ω RTD or Switch	Electrical Common
UI6	Input	0–10 VDC or 1000Ω RTD or Switch	Input 6 (Configurable)
UI7	Input	0–10 VDC or 1000Ω RTD or Switch	Input 7 (Configurable)
COM	Common	0–10 VDC or 1000Ω RTD or Switch	Electrical Common
UI8	Input	0–10 VDC or 1000Ω RTD or Switch	Input 8 (Configurable)
18VDC	Not Used	Not Used	Not Used



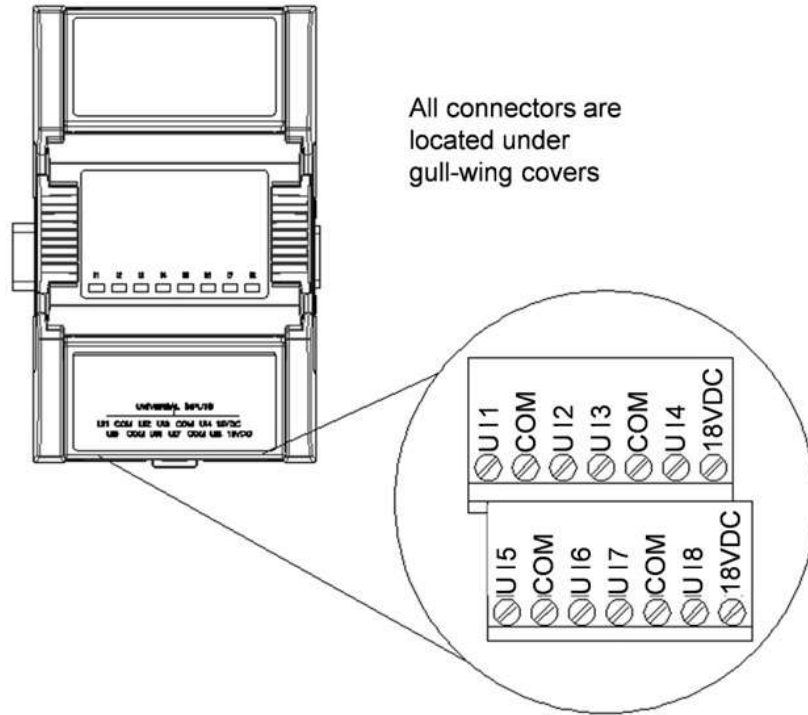

Figure 19: LR-EXP08 Input Only Module

## LR-EXP08 Input Only Module

### NOTE

COM on the input side is a shared common to be used by the surrounding inputs.

Pin Name	Connection Type	Signal Type	Description
UI1	Input	0–10 VDC or 1000Ω RTD or Switch	Input 1 (Configurable)
COM	Common	0–10 VDC or 1000Ω RTD or Switch	Electrical Common
UI2	Input	0–10 VDC or 1000Ω RTD or Switch	Input 2 (Configurable)
UI3	Input	0–10 VDC or 1000Ω RTD or Switch	Input 3 (Configurable)
COM	Common	0–10 VDC or 1000Ω RTD or Switch	Electrical Common
UI4	Input	0–10 VDC or 1000Ω RTD or Switch	Input 4 (Configurable)
18VDC	Not Used	Not Used	Not Used
UI5	Input	0–10 VDC or 1000Ω RTD or Switch	Input 5 (Configurable)
COM	Common	0–10 VDC or 1000Ω RTD or Switch	Electrical Common
UI6	Input	0–10 VDC or 1000Ω RTD or Switch	Input 6 (Configurable)
UI7	Input	0–10 VDC or 1000Ω RTD or Switch	Input 7 (Configurable)
COM	Common	0–10 VDC or 1000Ω RTD or Switch	Electrical Common
UI8	Input	0–10 VDC or 1000Ω RTD or Switch	Input 8 (Configurable)
18VDC	Not Used	Not Used	Not Used

*(This page intentionally left blank)*

# Appendix F

## Creating User Profiles and Access

Creating profiles will give other users access to the controller, along with allowing the administrator to limit access to certain functions as appropriate. Creation of other profiles must be done while logged into the **ADMIN** profile.

### Creating User Profiles

1. Connect to the Controller either through Wireless or Ethernet.
  - a. Refer to the [Hardware Programming](#) section for more information.
2. Open a browser and go to https:// IP address.
  - a. Refer to the [Hardware Programming](#) section for more information.
3. Click on “**Advanced>> Proceed to site.**”
4. Use the **Admin** credentials to Login to the controller.
5. Go to **Systems** section.
6. Go to **Users** section.



7. The following options will display:

<b>EDIT</b> 	To <b>EDIT</b> a user, select the user and click on the . The user's password, login page and privileges can be changed.
<b>DELETE</b> 	To <b>DELETE</b> a user, select the user and click on the .
<b>CREATE</b> 	To <b>CREATE</b> a user, select the user and click on the .
<b>PASSWORD POLICY</b> 	Password guidelines can be changed under Password Policy .

Follow these steps to create a user:

- a. First copy the link from an existing user.  
**Example:** /eclipse/envision/viewr.html?proj=Lab\_FFFF
- b. Click on any user that has a link and select **Edit**.
- c. Click on **Next** and **DO NOT** change anything until you reach the link section.
- d. Copy the link and select **cancel** instead of save.

- e. Click on **Create User**.
- f. Enter username and password for the user.
- g. Password guidelines can be changed under Password Policy  .
- h. Click on **Next** and select the user privilege.

**User Details**

**Eclipse Roles**

Admin  Operator  Viewer  Rest

**BLE Room Devices Roles**

Admin  Facility Manager  Space Owner

- i. Select **Admin** for highest privilege.
  - ii. Select **Operator** for emergency override.
  - iii. Select **Viewer** if user should only be allowed to view.
- i. Also select **Rest** if user should be allowed to make changes through EC-GFX program.
  - j. Click on **Next** and **Paste** the link that was copied earlier.
  - k. Save the user and exit.

# Appendix G

## Creating and Restoring a Backup File

Creating a backup file is a useful tool for replicating multiple similar controllers, or to preserve settings upon completion of setup.

### Creating a Backup

1. Connect to the Controller either through Wireless or Ethernet.
  - a. Refer to document on how to connect to controller through Wireless/Ethernet if required. See [“Connecting to the Laboratory Room Controller”](#) section earlier in the manual.
2. Open the Google Chrome™ internet browser and go to https:// IP address.
  - a. See [“Connecting to the Laboratory Room Controller”](#) section earlier in the manual” if IP address is unknown.
3. Click on **Advanced** and then **Proceed to site**.
4. Use the admin credentials to Login to the controller.
5. Go to **Systems** section.



6. Under the **Backup & Restore** the following options are available:

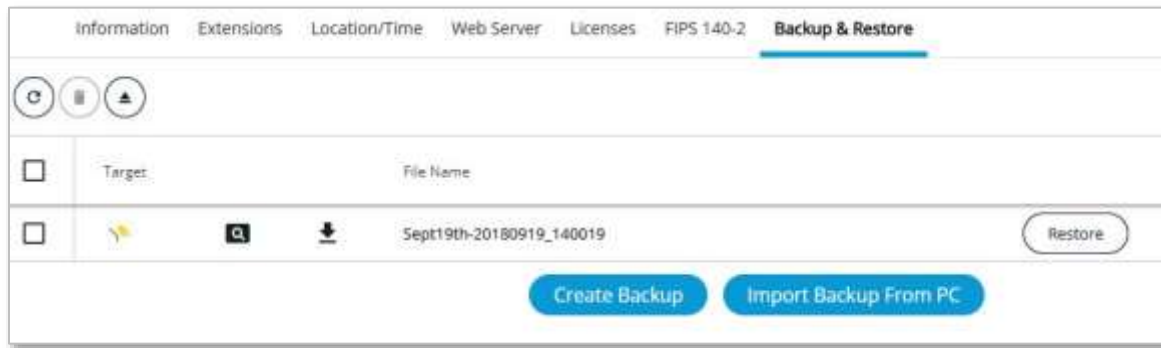

<b>DOWNLOAD</b> ↓	Backup files can be downloaded by selecting and clicking on the download icon.
	<ol style="list-style-type: none"><li>a) To create a new backup, click on <b>“Create Backup.”</b></li><li>b) Select all check boxes to transfer all data.</li><li>c) Once process is completed a new back up file will appear on the list.</li></ol>
	<ol style="list-style-type: none"><li>a) To import a backup file, click on <b>“Import Backup from PC.”</b></li><li>b) Navigate to the file and select it to upload to the controller.</li></ol>

*(This page intentionally left blank)*

## Appendix H

### Changing IP address from Static to Dynamic

1. ECLYPSE® controller can be programmed to static or dynamic IP.
2. Go to the login page of the controller by opening Google Chrome™ internet browser and going to the address https://IP address of the controller.
3. Click on **Advanced**>> **Proceed to site**.



4. Use the admin credentials to Login to the ECLYPSE® controller.
5. Under **Network** settings IP address of the Ethernet and Wireless can be changed.



6. Ethernet:
  - a. By Default the IP address is going to be **Dynamic**.
  - b. To make it static IP uncheck the box and give it a static IP address.
  - c. You may need to go back to Network and sharing center and change the TCP/IPv4 properties again if the IP address is in a different format. Example if initial IP was 192.168.254.10 and new IP is 172.16.254.10.
  - d. To make it Dynamic, check the DHCP box.
7. Wireless:
  - a. Default address for Wireless is 192.168.0.1.
  - b. The IP address can be changed in the same format.

#### NOTE

A brand new controller once programmed with the initial file that loads user and network setting will have a Static IP–192.168.200.90.

*(This page intentionally left blank)*



# Appendix I

## Network Communications

Network communications are available on the Laboratory Room Controllers. The controllers can communicate with a building management system through BACnet® MS/TP protocol.

### NOTE

Using Auto Discovery may take a while since it is pulling in all the points available. Go through the points list attached and pull the points needed.

## Laboratory Room Controller BACnet® Protocol Implementation Conformance Statement

**Date:** July 25, 2017

**Vendor Name:** TSI® Incorporated

**Product Name:** Laboratory Room Controller

**Product Model Number:** LRC

**Applications Software Version:** 1.8.17191.284

**Firmware Revision:** 1.14.17191.1

**BACnet® Protocol Revision:** Version 1, Rev 14

### Product Description:

The TSI LRC is a modular and scalable platform that is used to control a wide range of HVAC applications. It supports multi-protocol communications including BACnet®/IP and is a listed BACnet® Building Controller (B-BC).

The Laboratory Room Controller consists of a control, automation and connectivity server, power supply, and I/O extension modules.

This programmable Connected System Controller provides advanced functionality such as customizable control logic, Web-based design and visualization interface logging, alarming, and scheduling.

### BACnet Standardized Device Profile (Annex L):

- BACnet® Advanced Workstation (B-AWS)
- BACnet® Operator Workstation (B-OWS)
- BACnet® Operator Display (B-OD)
- BACnet® Building Controller (B-BC)
- BACnet® Advanced Application Controller (B-AAC)
- BACnet® Application Specific Controller (B-ASC)
- BACnet® Smart Sensor (B-SS)
- BACnet® Smart Actuator (B-SA)

### All BACnet® Interoperability Building Blocks Supported (Annex K): Required for B-BC Profile

Application Service	BIBBS
Data Sharing–ReadProperty–A	DS-RP-A
Data Sharing–ReadProperty–B	DS-RP-B
Data Sharing–ReadPropertyMultiple–A	DS-RPM-A
Data Sharing–ReadPropertyMultiple–B	DS-RPM-B
Data Sharing–WriteProperty–A	DC-WP-A
Data Sharing–WriteProperty–B	DC-WP-B
Data Sharing–WritePropertyMultiple–A	DS-WPM-A

Application Service	BIBBS
Data Sharing–WritePropertyMultiple–B	DS-WPM-B
Trending–Automated Trend Retrieval–B	T-ATR-B
Trending–Viewing and Modifying Trends Internal–B	T-VMT-I-B
Alarm and Event–Notification–A	AE-N-A
Alarm and Event–Notification Internal–B	AE-N-I-B
Alarm and Event–Notification External–B	AE-N-E-B
Alarm and Event–Alarm and Event-ACK–B	AE-ACK-B
Alarm and Event–Information–B	AE-INFO-B
Alarm and Event-Enrollment Summary–B	AE-ESUM-B
Scheduling–External–B	SCHED-E-B
Device Management–Dynamic Device Binding–A	DM-DDB-A
Device Management–Dynamic Device Binding–B	DM-DDB-B
Device Management–Dynamic Object Binding–B	DM-DOB-B
Device Management–DeviceCommunicationControl–B	DM-DCC-B
Device Management–TimeSynchronization–B	DM-TS-B
Device Management–UTCTimeSynchronization–B	DM-UTC-B
Device Management–ReinitializeDevice–B	DM-RD-B
Device Management–Backup and Restore–B	DM-BR-B

### Not Required for B-BC Profile

Application Service	BIBBS
Scheduling–Internal–B	SCHED-I-B
Alarm and Event–Alarm Summary–B	AE-ASUM-B
Data Sharing–COV–A	DS-COV-A
Data Sharing–COV–B	DS-COV-B
Data Sharing–COV–Property–B	DS-COVP-B
Data Sharing–COV–Unsubscribed–A	DS-COVU-A
Data Sharing–COV–Unsubscribed–B	DS-COVU-B
Trending–Viewing and Modifying Trends External–B	T-VMT-E-B
Device Management–Automatic Time Synchronization–Initiate	DM-ATS-A
Device Management–Manual Time Synchronization–Initiate	DM-MTS-A
Device Management–List Manipulation–B	DM-LM-B
Device Management–Object Creation and Deletion–B	DM-OCD-B
Remote Device Management–Confirmed Private Transfer	N/A
Remote Device Management–Unconfirmed Private Transfer	N/A

### Standard Object Types Supported:

The following is a list of the standard object types as define by the standard. The objects checked are currently supported by this product. See the section in this document for the supported object type for details.

- |   |  |  |
|---|--|--|
| <input type="checkbox"/> Accumulator              | <input checked="" type="checkbox"/> Calendar         | <input checked="" type="checkbox"/> Loop               |
| <input checked="" type="checkbox"/> Analog Input  | <input type="checkbox"/> Command                     | <input checked="" type="checkbox"/> Multistate Input   |
| <input checked="" type="checkbox"/> Analog Output | <input checked="" type="checkbox"/> Device           | <input type="checkbox"/> Multistate Output             |
| <input checked="" type="checkbox"/> Analog Value  | <input checked="" type="checkbox"/> Event Enrollment | <input checked="" type="checkbox"/> Multistate Value   |
| <input type="checkbox"/> Averaging                | <input checked="" type="checkbox"/> File             | <input checked="" type="checkbox"/> Notification Class |
| <input checked="" type="checkbox"/> Binary Input  | <input type="checkbox"/> Group                       | <input checked="" type="checkbox"/> Program            |
| <input checked="" type="checkbox"/> Binary Output | <input type="checkbox"/> Life Safety Point           | <input type="checkbox"/> Pulse Converter               |
| <input checked="" type="checkbox"/> Binary Value  | <input type="checkbox"/> Life Safety Zone            | <input checked="" type="checkbox"/> Schedule           |
|   |  | <input checked="" type="checkbox"/> Trend Log          |

## BACnet® Analog Input (AI) Object Type

Dynamically Creatable

Dynamically Deletable

BACnet® Analog Input (AI)	Mandatory	Optional	Proprietary	RW	ID	Range
Object_Identifier	■			R	75	
Object_Name	■			RW	77	
Object_Type	■			R	79	
Present_Value	■			R	85	
Description		■		RW	28	
Device_Type		■		R	31	
Status_Flags	■			R	111	
Event_State	■			R	36	
Reliability		■		R	103	
Out_Of_Service	■			RW	81	
Update_Interval		■		R	118	
Units	■			R	117	
Min_Pres_Value		■		R	69	
Max_Pres_Value		■		R	65	
Resolution		■		R	106	
COV_Increment		■		RW	22	
COV_Period			■	RW	1004	
COV_Min_Send_Time			■	RW	1000	
Time_Delay		■		RW	113	
Notification_Class		■		RW	17	
High_Limit		■		RW	45	
Low_Limit		■		RW	59	
Deadband		■		RW	25	
Limit_Enable		■		RW	52	
Event_Enable		■		RW	35	
Acked_Transitions		■		R	0	
Notify_Type		■		RW	72	
Event_Time_Stamps		■		R	130	
Event_Message_Texts		■		R	351	
Event_Message_Texts_Config		■		RW	352	
Event_Detection_Enable		■		RW	353	
Time_Delay_Normal		■		RW	356	
Event_Algorithm_Inhibit		■		RW	354	
Event_Algorithm_Inhibit_Ref		■		RW	355	
Property_List	■			R	371	

## BACnet® Analog Output (AO) Object Type

Dynamically Creatable

Dynamically Deletable

BACnet® Analog Output (AO)	Mandatory	Optional	Proprietary	RW	ID	Range
Object_Identifier	■			R	75	
Object_Name	■			RW	77	
Object_Type	■			R	79	
Present_Value	■			R	85	
Description		■		RW	28	
Device_Type		■		R	31	
Status_Flags	■			R	111	
Event_State	■			R	36	
Reliability		■		R	103	
Out_Of_Service	■			RW	81	
Units	■			R	117	
Min_Pres_Value		■		R	69	
Max_Pres_Value		■		R	65	
Resolution		■		R	106	
Priority_Array	■			R	87	
Relinquish_Default	■			RW	104	
COV_Increment		■		RW	22	
COV_Period			■	RW	1004	
COV_Min_Send_Time			■	RW	1000	
Time_Delay		■		RW	113	
Notification_Class		■		RW	17	
High_Limit		■		RW	45	
Low_Limit		■		RW	59	
Deadband		■		RW	25	
Limit_Enable		■		RW	52	
Event_Enable		■		RW	35	
Acked_Transitions		■		R	0	
Notify_Type		■		RW	72	
Event_Time_Stamps		■		R	130	
Event_Message_Texts		■		R	351	
Event_Message_Texts_Config		■		RW	352	
Event_Detection_Enable		■		RW	353	
Time_Delay_Normal		■		RW	356	
Event_Algorithm_Inhibit		■		RW	354	
Event_Algorithm_Inhibit_Ref		■		RW	355	
Property_List	■			R	371	

## BACnet® Analog Value (AV) Object Type

Dynamically Creatable

Dynamically Deletable

BACnet® Analog Value (AV)	Mandatory	Optional	Proprietary	RW	ID	Range
Object_Identifier	■			R	75	
Object_Name	■			RW	77	
Object_Type	■			R	79	
Present_Value	■			RW	85	
Description		■		RW	28	
Status_Flags	■			R	111	
Event_State	■			R	36	
Reliability		■		R	103	
Out_Of_Service	■			RW	81	
Units	■			R	117	
Priority_Array		■		R	87	
Relinquish_Default		■		RW	104	
Min_Pres_Value		■		R	69	
Max_Pres_Value		■		R	65	
COV_Increment		■		RW	22	
COV_Period			■	RW	1004	
COV_Min_Send_Time			■	RW	1000	
Time_Delay		■		RW	113	
Notification_Class		■		RW	17	
High_Limit		■		RW	45	
Low_Limit		■		RW	59	
Deadband		■		RW	25	
Limit_Enable		■		RW	52	
Event_Enable		■		RW	35	
Acked_Transitions		■		R	0	
Notify_Type		■		RW	72	
Event_Time_Stamps		■		R	130	
Event_Message_Texts		■		R	351	
Event_Message_Texts_Config		■		RW	352	
Event_Detection_Enable		■		RW	353	
Time_Delay_Normal		■		RW	356	
Event_Algorithm_Inhibit		■		RW	354	
Event_Algorithm_Inhibit_Ref		■		RW	355	
Property_List	■			R	371	

## BACnet® Binary Input (BI) Object Type

Dynamically Creatable

Dynamically Deletable

BACnet® Binary Input (BI)	Mandatory	Optional	Proprietary	RW	ID	Range
Object_Identifier	■			R	75	
Object_Name	■			RW	77	
Object_Type	■			R	79	
Present_Value	■			RW	85	
Description		■		RW	28	
Device_Type		■		R	31	
Status_Flags	■			R	111	
Event_State	■			R	36	
Reliability		■		R	103	
Out_Of_Service	■			RW	81	
Polarity	■			R	84	
Inactive_Text		■		R	46	
Active_Text		■		R	4	
Change_Of_State_Time		■		R	16	
Change_Of_State_Count		■		RW	15	
Time_Of_State_Count_Reset		■		RW	115	
Elapsed_Active_Time		■		RW	33	
Time_Of_Active_Time_Reset		■		RW	114	
COV_Period			■	RW	1004	
COV_Min_Send_Time			■	RW	1000	
Time_Delay		■		RW	113	
Notification_Class		■		RW	17	
Alarm_Value		■		RW	45	
Event_Enable		■		RW	35	
Acked_Transitions		■		R	0	
Notify_Type		■		RW	72	
Event_Time_Stamps		■		R	130	
Event_Message_Texts		■		R	351	
Event_Message_Texts_Config		■		RW	352	
Event_Detection_Enable		■		RW	353	
Time_Delay_Normal		■		RW	356	
Event_Algorithm_Inhibit		■		RW	354	
Event_Algorithm_Inhibit_Ref		■		RW	355	
Property_List	■			R	371	

## BACnet® Binary Output (BO) Object Type

Dynamically Creatable

Dynamically Deletable

BACnet® Binary Output (BO)	Mandatory	Optional	Proprietary	RW	ID	Range
Object_Identifier	■			R	75	
Object_Name	■			RW	77	
Object_Type	■			R	79	
Present_Value	■			RW	85	
Description		■		RW	28	
Device_Type		■		R	31	
Status_Flags	■			R	111	
Event_State	■			R	36	
Reliability		■		R	103	
Out_Of_Service	■			RW	81	
Polarity	■			R	84	
Inactive_Text		■		R	46	
Active_Text		■		R	4	
Change_Of_State_Time		■		R	16	
Change_Of_State_Count		■		RW	15	
Time_Of_State_Count_Reset		■		RW	115	
Elapsed_Active_Time		■		RW	33	
Time_Of_Active_Time_Reset		■		RW	114	
Minimum_Off_Time		■		RW	66	
Maximum_Off_time		■		RW	67	
Priority_Array		■		R	87	
Relinquish_Default		■		RW	104	
COV_Period			■	RW	1004	
COV_Min_Send_Time			■	RW	1000	
Time_Delay		■		RW	113	
Notification_Class		■		RW	17	
Feedback_Value		■		R	40	
Event_Enable		■		RW	35	
Acked_Transitions		■		R	0	
Notify_Type		■		RW	72	
Event_Time_Stamps		■		R	130	
Event_Message_Texts		■		R	351	
Event_Message_Texts_Config		■		RW	352	
Event_Detection_Enable		■		RW	353	
Time_Delay_Normal		■		RW	356	
Event_Algorithm_Inhibit		■		RW	354	
Event_Algorithm_Inhibit_Ref		■		RW	355	
Property_List		■		R	371	

## BACnet® Binary Value (BV) Object Type

Dynamically Creatable

Dynamically Deletable

BACnet® Binary Value (BV)	Mandatory	Optional	Proprietary	RW	ID	Range
Object_Identifier	■			R	75	
Object_Name	■			RW	77	
Object_Type	■			R	79	
Present_Value	■			RW	85	
Description		■		RW	28	
Status_Flags	■			R	111	
Event_State	■			R	36	
Reliability		■		R	103	
Out_Of_Service	■			RW	81	
Inactive_Text		■		R	46	
Active_Text		■		R	4	
Change_Of_State_Time		■		R	16	
Change_Of_State_Count		■		RW	15	
Time_Of_State_Count_Reset		■		RW	115	
Elapsed_Active_Time		■		RW	33	
Time_Of_Active_Time_Reset		■		RW	114	
Minimum_Off_Time		■		RW	66	
Maximum_Off_time		■		RW	67	
Priority_Array		■		R	87	
Relinquish_Default		■		RW	104	
COV_Period			■	RW	1004	
COV_Min_Send_Time			■	RW	1000	
Time_Delay		■		RW	113	
Notification_Class		■		RW	17	
Alarm_Value		■		RW	6	
Event_Enable		■		RW	35	
Acked_Transitions		■		R	0	
Notify_Type		■		RW	72	
Event_Time_Stamps		■		R	130	
Event_Message_Texts		■		R	351	
Event_Message_Texts_Config		■		RW	352	
Event_Detection_Enable		■		RW	353	
Time_Delay_Normal		■		RW	356	
Event_Algorithm_Inhibit		■		RW	354	
Event_Algorithm_Inhibit_Ref		■		RW	355	
Property_List		■		R	371	



## BACnet® Calendar Object Type

■ Dynamically Creatable

■ Dynamically Deletable

BACnet® Calendar	Mandatory	Optional	Proprietary	RW	ID	Range
Object_Identifier	■			R	75	
Object_Name	■			RW	77	
Object_Type	■			R	79	
Present_Value	■			R	85	
Description		■		RW	28	
Date_List	■			RW	23	
Time_To_Next_State			■	R	1001	
Next_State			■	R	1002	
Property_List	■			R	371	

## Device Object

□ Dynamically Creatable

□ Dynamically Deletable

Device Object	Mandatory	Optional	Proprietary	RW	ID	Range
Object_Identifier	■			RW	75	
Object_Name	■			RW	77	
Object_Type	■			R	79	
System_Status	■			R	112	
Vendor_Name	■			R	121	
Vendor_Identifier	■			R	120	
Model_Name	■			R	70	
Firmware_Revision	■			R	44	
Application_Software_Version	■			R	12	
Location		■		RW	58	
Description		■		RW	28	
Protocol_Version	■			R	98	
Protocol_Revision	■			R	139	
Protocol_Services_Supported	■			R	97	
Protocol_Object_Types_Supported	■			R	96	
Object_List	■			R	76	
Max_APDU_Length_Accepted	■			R	62	
Segmentation_Supported	■			R	107	
Max_Segments_Supported	■			R	167	

Device Object	Mandatory	Optional	Proprietary	RW	ID	Range
Local_Date		■		R	56	
Local_Time		■		R	57	
UTC_Offset		■		R	119	
Daylight_Savings_Status		■		R	24	
Apdu_Segment_Timeout		■		RW	10	
APDU_Timeout	■			RW	10	
Number_Of_APDU_Retries	■			RW	73	
Time_Synchronization_Recipients		■		RW	116	
Device_Address_Binding	■			R	30	
Database_Revision	■			R	155	
Configuration_Files		■		R	154	
Last_Restore_Time		■		R	157	
Backup_Failure_Timeout		■		RW	153	
Backup_Preparation_Time		■		RW	339	
Restore_Preparation_Time		■		RW	341	
Restore-Completion_Time		■		RW	340	
Backup_And_Restore_State		■		R	155	
Active_COV_Subscriptions		■		R	152	
Last_Restart_Reason		■		R	196	
Time_Of_Device_Restart		■		R	203	
Restart_Notification_Recipients		■		RW	202	
UTC_Time_Synchronization_Recipients		■		RW	206	
Max_Master		■		RW	64	
Max_Info_Frames		■		RW	63	
Time_Synchronization_Interval		■		RW	204	
Align_Intervals		■		RW	193	
Interval_Offset		■		RW	195	
Property_List	■			R	371	

## Event Enrollment Object

- Dynamically Creatable
- Dynamically Deletable

Event Enrollment	Mandatory	Optional	Proprietary	RW	ID	Range
Object_Identifier	■			R	75	
Object_Name	■			RW	77	
Object_Type	■			R	79	
Description		■		RW	28	
Event_Type	■			R	37	
Notify_Type	■			RW	72	
Event_Parameters	■			RW	83	
Object_Property_Reference	■			RW	78	
Event_State	■			R	36	
Event_Enable	■			RW	35	
Acked_Transitions	■			R	0	
Notification_Class	■			RW	17	
Event_Time_Stamps	■			R	130	
Event_Message_Texts		■		R	351	
Event_Message_Texts_Config		■		RW	352	
Event_Detection_Enable	■			RW	353	
Time_Delay_Normal		■		RW	356	
Status_Flags	■			R	111	
Reliability	■			R	103	
Property_List	■			R	371	

## BACnet® File Object Type

Dynamically Creatable

Dynamically Deletable

BACnet® File	Mandatory	Optional	Proprietary	RW	ID	Range
Object_Identifier	■			R	75	
Object_Name	■			R	77	
Object_Type	■			R	79	
Description		■		RW	28	
File_Type	■			R	43	
File_Size	■			R	42	
Modification_Date	■			R	71	
Archive	■			RW	13	
Read_Only	■			R	99	
File_Access_Method	■			R	41	
Property_List	■			R	371	

## BACnet® Loop Object Type

■ Dynamically Creatable

■ Dynamically Deletable

BACnet® Loop	Mandatory	Optional	Proprietary	RW	ID	Range
Object_Identifier	■			R	75	
Object_Name	■			RW	77	
Object_Type	■			R	79	
Present_Value	■			R	85	
Description		■		RW	28	
Status_Flags	■			R	111	
Event_State	■			R	36	
Reliability		■		R	103	
Out_Of_Service	■			RW	81	
Update_Interval		■		R	118	
Output_Units	■			R	82	
Manipulated_Variable_Reference	■			R	60	
Controlled_Variable_Reference	■			R	19	
Controlled_Variable_Value	■			R	21	
Controlled_Variable_Units	■			R	20	
Setpoint_Reference	■			R	109	
Setpoint	■			R	108	
Action	■			RW	2	

BACnet® Loop						
Property Name	Mandatory	Optional	Proprietary	RW	ID	Range
Proportional_Constant		■		RW	93	
Proportional_Constant_Units		■		R	94	
Integral_Constant		■		RW	49	
Integral_Constant_Units		■		R	50	
Derivative_Constant		■		RW	26	
Derivative_Constant_Units		■		R	27	
Bias		■		RW	14	
Maximum_Output		■		RW	61	
Minimum_Output		■		RW	68	
Priority_For_Writing	■			R	88	
LoopDeadband			■	RW	1011	
Saturation_Time			■	RW	1003	
COV_Increment		■		RW	22	
COV_Period			■	RW	1004	
COV_Min_Send_Time			■	RW	1000	
Ramp_Time			■	RW	1005	
Saturation_Time_Low_Limit_Enable			■	RW	1006	
Saturation_Time_High_Limit_Enable			■	RW	1007	
Time_Delay		■		RW	113	
Notification_Class		■		RW	17	
Error_Limit		■		RW	34	
Deadband		■		RW	25	
Event_Enable		■		RW	35	
Acked_Transitions		■		R	0	
Notify_Type		■		RW	72	
Event_Time_Stamps		■		R	130	
Event_Message_Texts		■		R	351	
Event_Message_Texts_Config		■		RW	352	
Event_Detection_Enable		■		RW	353	
Time_Delay_Normal		■		RW	356	
Event_Algorithm_Inhibit		■		RW	354	
Event_Algorithm_Inhibit_Ref		■		RW	355	
Property_List	■			R	371	

## BACnet® Multi-State Input (MSI) Object Type

Dynamically Creatable

Dynamically Deletable

BACnet® Multi-State Input (MSI)	Mandatory	Optional	Proprietary	RW	ID	Range
Object_Identifier	■			R	75	
Object_Name	■			RW	77	
Object_Type	■			R	79	
Present_Value	■			R	85	
Description		■		RW	28	
Device_Type		■		R	31	
Status_Flags	■			R	111	
Event_State	■			R	36	
Reliability		■		R	103	
Out_Of_Service	■			RW	81	
Number_Of_States	■			R	74	
State_Text		■		R	110	
COV_Period			■	RW	1004	
COV_Min_Send_Time			■	RW	1000	
Time_Delay		■		RW	113	
Notification_Class		■		RW	17	
Alarm_Values		■		RW	7	
Fault_Values		■		RW	39	
Event_Enable		■		RW	35	
Acked_Transitions		■		R	0	
Notify_Type		■		RW	72	
Event_Time_Stamps		■		R	130	
Event_Message_Texts		■		R	351	
Event_Message_Texts_Config		■		RW	352	
Event_Detection_Enable		■		RW	353	
Time_Delay_Normal		■		RW	356	
Event-Algorithm_Inhibit		■		RW	354	
Event-Algorithm_Inhibit_Ref		■		RW	355	
Property_List	■			R	371	

## BACnet® Multi-State Value (MSV) Object Type

Dynamically Creatable

Dynamically Deletable

BACnet® Multi-State Value (MSV)	Mandatory	Optional	Proprietary	RW	ID	Range
Object_Identifier	■			R	75	
Object_Name	■			RW	77	
Object_Type	■			R	79	
Present_Value	■			RW	85	
Description		■		RW	28	
Status_Flags	■			R	111	
Event_State	■			R	36	
Reliability		■		R	103	
Out_Of_Service	■			RW	81	
Number_Of_States	■			R	74	
State_Text		■		R	110	
Priority_Array		■		R	87	
Relinquish_Default		■		RW	104	
COV_Period			■	RW	1004	
COV_Min_Send_Time			■	RW	1000	
Time_Delay		■		RW	113	
Notification_Class		■		RW	17	
Alarm_Values		■		RW	7	
Fault_Values		■		RW	39	
Event_Enable		■		RW	35	
Acked_Transitions		■		R	0	
Notify_Type		■		RW	72	
Event_Time_Stamps		■		R	130	
Event_Message_Texts		■		R	351	
Event_Message_Texts_Config		■		RW	352	
Event_Detection_Enable		■		RW	353	
Time_Delay_Normal		■		RW	356	
Event-Algorithm_Inhibit		■		RW	354	
Event-Algorithm_Inhibit_Ref		■		RW	355	
Property_List		■		R	371	

### BACnet® Program Object Type

Dynamically Creatable

Dynamically Deletable

BACnet® Program	Mandatory	Optional	Proprietary	RW	ID	Range
Object_Identifier	■			R	75	
Object_Name	■			RW	77	
Object_Type	■			R	79	
Description		■		RW	28	
Program_State	■			R	92	
Program_Change	■			RW	90	
Description_Of_Halt		■		R	29	
Reason_For_Halt		■		R	100	
Status_Flags	■			R	111	
Reliability		■		R	103	
Out_Of_Service	■			RW	81	
Property_List	■			R	371	

### BACnet® Notification Class Type

■ Dynamically Creatable

■ Dynamically Deletable

BACnet® Notification Class Type	Mandatory	Optional	Proprietary	RW	ID	Range
Object_Identifier	■			R	75	
Object_Name	■			RW	77	
Object_Type	■			R	79	
Description		■		RW	28	
Notification_Class	■			R	17	
Priority	■			RW	86	
Ack_Required	■			RW	1	
Recipient_List	■			RW	102	
Property_List	■			R	371	



## BACnet® Schedule Object Type

■ Dynamically Creatable

■ Dynamically Deletable

BACnet® Schedule	Mandatory	Optional	Proprietary	RW	ID	Range
Object_Identifier	■			R	75	
Object_Name	■			RW	77	
Object_Type	■			R	79	
Description		■		RW	28	
Present_Value	■			R	92	
Effective_Period	■			RW	32	
Weekly_Schedule		■		RW	123	
Exception_Schedule		■		RW	38	
Schedule_Default	■			RW	174	
List_Of_Object_Property_References	■			RW	54	
Priority_For_Writing	■			W	88	
Status_Flags	■			R	111	
Reliability		■		R	103	
Out_Of_Service	■			RW	81	
Time_To_Next_State		■		R	1001	
Next_State		■		R	1002	
Property_List	■			R	371	

## BACnet® Trend Log Object Type

■ Dynamically Creatable

■ Dynamically Deletable

BACnet® Trend Log	Mandatory	Optional	Proprietary	RW	ID	Range
Object_Identifier	■			R	75	
Object_Name	■			RW	77	
Object_Type	■			R	79	
Description		■		RW	28	
Enable	■			RW	133	
Start_Time		■		RW	142	
Stop_Time		■		RW	143	
Log_Device_Object_Property		■		RW	132	
Log_Interval		■		RW	134	
COV_Resubscription_Interval		■		RW	128	
Client_COV_Increment		■		RW	127	
Stop_When_Full	■			RW	144	
Buffer_Size	■			RW	126	
Log_Buffer	■			R	131	
Record_Count	■			RW	141	
Total_Record_Count	■			R	145	
Logging_Type	■			RW	197	
Align_Intervals		■		RW	193	
Interval_Offset		■		RW	195	
Trigger		■		RW	205	
Status_Flags	■			R	111	
Reliability		■		R	103	
Notification_Threshold		■		RW	137	
Records_Since_Notification		■		R	140	
Last_Notify_Record		■		R	173	
Event_State	■			R	36	
Notification_Class		■		RW	17	
Event_Enable		■		RW	35	
Acked_Transitions		■		R	0	
Notify_Type		■		RW	208	
Event_Time_Stamps		■		R	130	
Event_Message_Texts		■		R	351	
Event_Message_Texts_Config		■		RW	352	
Event_Detection_Enable		■		RW	353	
Event_Algorithm_Inhibit		■		RW	354	
Event_Algorithm_Inhibit_Ref		■		RW	355	
Property_List	■			R	371	

**Segmentation Capability:**

- Segmented requests supported                      Window Size: 255
- Segmented responses supported                      Window Size: 255

**Data Link Layer Options:**

- BACnet® IP, (Annex J)
- BACnet® IP, (Annex J), Foreign Device
- ISO 8802-3, Ethernet (Clause 7)
- ANSI/ATA 878.1, 2.5 Mb. ARCNET (Clause 8)
- ANSI/ATA 878.1, RS-485 ARCNET (Clause 8), baud rate(s)\_\_\_\_\_
- MS/TP master (Clause 9), baud rate(s): 9600, 19200, 38400, 76800, 115200
- MS/TP slave (Clause 9), baud rate(s): \_\_\_\_\_
- Point-To-Point, EIA 232 (Clause 10), baud rate(s):\_\_\_\_\_
- Point-To-Point, modem, (Clause 10), baud rate(s): \_\_\_\_\_
- LonTalk, (Clause 11), medium: \_\_\_\_\_
- Other: \_\_\_\_\_

**Device Address Binding:**

Is static device binding supported?                       Yes       No

**Networking Options:**

- Router, Clause 6–Routing configurations: IP-MS/TP
- Annex H, BACnet® Tunneling Router over IP
- BACnet®/IP Broadcast Management Device (BBMD)  
Does the BBMD support registrations by Foreign Devices?                       Yes       No

**Character Sets Supported:**

Indicating support for multiple character sets does not imply that they can all be supported simultaneously.

- UTF-8                       IBM®/Microsoft® DBCS                       ISO 8859-1
- ISO 10646 (UCS-2)                       ISO 10646 (UCS-4)                       JIS C 6226

**If this product is a communication gateway, describe the types of non-BACnet® equipment/networks(s) that the gateway supports:**

Not applicable

## BACnet® Object Set

All points are readable and writable over the BAS (Building Automation System) network. Caution should be used when overwriting values since this may cause a loss in room control.

### NOTE

Using Auto Discovery may take a while since it is pulling in all the points available. Go through the points list attached and pull the points needed.

BACnet Object Set Object	Description	Units			Notes
		LRC00	-LPS	-CMH	
Analog Value 1	Supply 1 Pitot Uncal Low Cal Flow	CFM	LPS	CMH	DO NOT OVERWRITE
Analog Value 2	Supply 1 Pitot Uncal High Cal Flow	CFM	LPS	CMH	DO NOT OVERWRITE
Analog Value 3	Supply 1 Venturi Minimum Flow	CFM	LPS	CMH	
Analog Value 4	Supply 1 Venturi Maximum Flow	CFM	LPS	CMH	
Analog Value 5	Supply 1 Flow K Factor				
Analog Value 6	Supply 1 Venturi Setup Position	% Open			
Analog Value 7	Supply 1 Venturi LOM Esc Time	seconds			
Analog Value 8	Supply 1 Linear Duct Area	FT <sup>2</sup>	M <sup>2</sup>	M <sup>2</sup>	
Analog Value 9	Not applicable	Not applicable			Not applicable
Analog Value 10	Supply 1 Linear Top Velocity	FT/ MIN	M/S	M/S	
Analog Value 11	Supply 1 Linear Signal Minimum	VOLTS			
Analog Value 12	Supply 1 Linear Signal Maximum	VOLTS			
Analog Value 13	Supply 1 Pitot Sensor Zero	VOLTS			DO NOT OVERWRITE
Analog Value 14	Supply 1 Transducer Signal Minimum	VOLTS			
Analog Value 15	Supply 1 Transducer Signal Maximum	VOLTS			
Analog Value 16	Supply 1 Pitot Duct Area	FT <sup>2</sup>	M <sup>2</sup>	M <sup>2</sup>	
Analog Value 17	Supply 5 Flow Error	0	0	0	DO NOT READ OR OVERWRITE
Analog Value 18	Supply 1 Transducer Sensor Maximum	in. W.C.	Pa	Pa	
Analog Value 19	Supply 1 Pitot Low Cal Pos	% Open			
Analog Value 20	Supply 1 Pitot High Cal Pos	% Open			
Analog Value 21	Supply 1 Pitot Low Cal Flow	CFM	LPS	CMH	
Analog Value 22	Supply 1 Pitot High Cal Flow	CFM	LPS	CMH	
Analog Value 23	Supply 2 Pitot Uncal High Cal Flow	CFM	LPS	CMH	DO NOT OVERWRITE
Analog Value 24	Supply 2 Pitot Uncal Low Cal Flow	CFM	LPS	CMH	DO NOT OVERWRITE
Analog Value 25	Supply 2 Venturi Minimum Flow	CFM	LPS	CMH	
Analog Value 26	Supply 2 Venturi Maximum Flow	CFM	LPS	CMH	
Analog Value 27	Supply 2 Flow K Factor				
Analog Value 28	Supply 2 Venturi Setup Position	% Open			
Analog Value 29	Supply 2 Venturi LOM Esc Time	SECONDS			
Analog Value 30	Supply 2 Linear Duct Area	FT <sup>2</sup>	M <sup>2</sup>	M <sup>2</sup>	
Analog Value 31	Not applicable	Not applicable			Not applicable
Analog Value 32	Supply 2 Linear Top Velocity	FT/MIN	M/S	M/S	
Analog Value 33	Supply 2 Linear Signal Minimum	VOLTS			
Analog Value 34	Supply 2 Linear Signal Maximum	VOLTS			
Analog Value 35	Supply 2 Pitot Sensor Zero	VOLTS			DO NOT OVERWRITE
Analog Value 36	Supply 2 Pitot Low Cal Pos	% Open			

BACnet Object Set	Description	Units			Notes
		LRC00	-LPS	-CMH	
Analog Value 37	Supply 2 Transducer Signal Minimum	VOLTS			
Analog Value 38	Supply 2 Pitot High Cal Pos	% Open			
Analog Value 39	Supply 2 Transducer Signal Maximum	VOLTS			
Analog Value 40	Supply 2 Pitot Low Cal Flow	CFM	LPS	CMH	
Analog Value 41	Supply 2 Pitot Duct Area	FT <sup>2</sup>	M <sup>2</sup>	M <sup>2</sup>	
Analog Value 42	Supply 2 Pitot High Cal Flow	CFM	LPS	CMH	
Analog Value 43	Supply 6 Flow Error	0	0	0	DO NOT READ OR OVERWRITE
Analog Value 44	Supply 2 Transducer Sensor Maximum	in. W.C.	Pa	Pa	
Analog Value 45	Supply 3 Pitot Uncal Low Cal Flow	CFM	LPS	CMH	DO NOT OVERWRITE
Analog Value 46	Supply 3 Pitot Uncal High Cal Flow	CFM	LPS	CMH	DO NOT OVERWRITE
Analog Value 47	Supply 3 Venturi Minimum Flow	CFM	LPS	CMH	
Analog Value 48	Supply 3 Venturi Maximum Flow	CFM	LPS	CMH	
Analog Value 49	Supply 3 Flow K Factor				
Analog Value 50	Supply 3 Venturi Setup Position	% Open			
Analog Value 51	Supply 3 Venturi LOM Esc Time	SECONDS			
Analog Value 52	Supply 3 Linear Duct Area	FT <sup>2</sup>	M <sup>2</sup>	M <sup>2</sup>	
Analog Value 53	Not applicable	Not applicable			Not applicable
Analog Value 54	Supply 3 Linear Top Velocity	FT/MIN	M/S	M/S	
Analog Value 55	Supply 3 Linear Signal Minimum	VOLTS			
Analog Value 56	Supply 3 Linear Signal Maximum	VOLTS			
Analog Value 57	Supply 3 Pitot Sensor Zero	VOLTS			DO NOT OVERWRITE
Analog Value 58	Supply 3 Pitot Low Cal Pos	% Open			
Analog Value 59	Supply 3 Transducer Signal Minimum	VOLTS			
Analog Value 60	Supply 3 Pitot High Cal Pos	% Open			
Analog Value 61	Supply 3 Transducer Signal Maximum	VOLTS			
Analog Value 62	Supply 3 Pitot Low Cal Flow	CFM	LPS	CMH	
Analog Value 63	Supply 3 Pitot Duct Area	FT <sup>2</sup>	M <sup>2</sup>	M <sup>2</sup>	
Analog Value 64	Supply 3 Pitot High Cal Flow	CFM	LPS	CMH	
Analog Value 65	Old Supply 5 Error	0	0	0	DO NOT READ OR OVERWRITE
Analog Value 66	Supply 3 Transducer Sensor Maximum	in. W.C.	Pa	Pa	
Analog Value 67	Supply 4 Pitot Uncal Low Cal Flow	CFM	LPS	CMH	DO NOT OVERWRITE
Analog Value 68	Supply 4 Pitot Uncal High Cal Flow	CFM	LPS	CMH	DO NOT OVERWRITE
Analog Value 69	Supply 4 Venturi Minimum Flow	CFM	LPS	CMH	
Analog Value 70	Supply 4 Venturi Maximum Flow	CFM	LPS	CMH	
Analog Value 71	Supply 4 Flow K Factor				
Analog Value 72	Supply 4 Venturi Setup Position	% Open			
Analog Value 73	Supply 4 Venturi LOM Esc Time	SECONDS			
Analog Value 74	Supply 4 Linear Duct Area	FT <sup>2</sup>	M <sup>2</sup>	M <sup>2</sup>	
Analog Value 75	Not applicable	Not applicable			Not applicable
Analog Value 76	Supply 4 Linear Top Velocity	FT/MIN	M/S	M/S	
Analog Value 77	Supply 4 Linear Signal Minimum	VOLTS			
Analog Value 78	Supply 4 Linear Signal Maximum	VOLTS			
Analog Value 79	Supply 4 Pitot Sensor Zero	VOLTS			DO NOT OVERWRITE
Analog Value 80	Supply 4 Pitot Low Cal Pos	% Open			
Analog Value 81	Supply 4 Transducer Signal Minimum	VOLTS			

BACnet Object Set	Description	Units			Notes
		LRC00	-LPS	-CMH	
Analog Value 82	Supply 4 Pitot High Cal Pos	% Open			
Analog Value 83	Supply 4 Transducer Signal Maximum	VOLTS			
Analog Value 84	Supply 4 Pitot Low Cal Flow	CFM	LPS	CMH	
Analog Value 85	Supply 4 Pitot Duct Area	FT <sup>2</sup>	M <sup>2</sup>	M <sup>2</sup>	
Analog Value 86	Supply 4 Pitot High Cal Flow	CFM	LPS	CMH	
Analog Value 87	Old Supply 5 Error	0	0	0	DO NOT READ OR OVERWRITE
Analog Value 88	Supply 4 Transducer Sensor Maximum	in. W.C.	Pa	Pa	
Analog Value 89	Exhaust 1 Pitot Uncal Low Cal Flow	CFM	LPS	CMH	DO NOT OVERWRITE
Analog Value 90	Exhaust 1 Pitot Uncal High Cal Flow	CFM	LPS	CMH	DO NOT OVERWRITE
Analog Value 91	Exhaust 1 Venturi Minimum Flow	CFM	LPS	CMH	
Analog Value 92	Exhaust 1 Venturi Maximum Flow	CFM	LPS	CMH	
Analog Value 93	Exhaust 1 Flow K Factor				
Analog Value 94	Exhaust 1 Venturi Setup Position	% Open			
Analog Value 95	Exhaust 1 Venturi LOM Esc Time	SECONDS			
Analog Value 96	Exhaust 1 Linear Duct Area	FT <sup>2</sup>	M <sup>2</sup>	M <sup>2</sup>	
Analog Value 97	Not applicable	Not applicable			Not applicable
Analog Value 98	Exhaust 1 Linear Top Velocity	FT/MIN	M/S	M/S	
Analog Value 99	Exhaust 1 Linear Signal Minimum	VOLTS			
Analog Value 100	Exhaust 1 Linear Signal Maximum	VOLTS			
Analog Value 101	Exhaust 1 Pitot Sensor Zero	VOLTS			DO NOT OVERWRITE
Analog Value 102	Exhaust 1 Pitot Low Cal Pos	% Open			
Analog Value 103	Exhaust 1 Transducer Signal Minimum	VOLTS			
Analog Value 104	Exhaust 1 Pitot High Cal Pos	% Open			
Analog Value 105	Exhaust 1 Transducer Signal Maximum	VOLTS			
Analog Value 106	Exhaust 1 Pitot Low Cal Flow	CFM	LPS	CMH	
Analog Value 107	Exhaust 1 Pitot Duct Area	FT <sup>2</sup>	M <sup>2</sup>	M <sup>2</sup>	
Analog Value 108	Exhaust 1 Pitot High Cal Flow	CFM	LPS	CMH	
Analog Value 110	Exhaust 1 Transducer Sensor Maximum	in. W.C.	Pa	Pa	
Analog Value 111	Exhaust 2 Pitot Uncal Low Cal Flow	CFM	LPS	CMH	DO NOT OVERWRITE
Analog Value 112	Exhaust 2 Pitot Uncal High Cal Flow	CFM	LPS	CMH	DO NOT OVERWRITE
Analog Value 113	Exhaust 2 Venturi Minimum Flow	CFM	LPS	CMH	
Analog Value 114	Exhaust 2 Venturi Maximum Flow	CFM	LPS	CMH	
Analog Value 115	Exhaust 2 Flow K Factor				
Analog Value 116	Exhaust 2 Venturi Setup Position	% Open			
Analog Value 117	Exhaust 2 Venturi LOM Esc Time	SECONDS			
Analog Value 118	Exhaust 2 Linear Duct Area	FT <sup>2</sup>	M <sup>2</sup>	M <sup>2</sup>	
Analog Value 119	Not applicable	Not applicable			Not applicable
Analog Value 120	Exhaust 2 Linear Top Velocity	FT/MIN	M/S	M/S	
Analog Value 121	Exhaust 2 Linear Signal Minimum	VOLTS			
Analog Value 122	Exhaust 2 Linear Signal Maximum	VOLTS			
Analog Value 123	Exhaust 2 Pitot Sensor Zero	VOLTS			DO NOT OVERWRITE
Analog Value 124	Exhaust 2 Pitot Low Cal Pos	% Open			
Analog Value 125	Exhaust 2 Transducer Signal Minimum	VOLTS			
Analog Value 126	Exhaust 2 Pitot High Cal Pos	% Open			
Analog Value 127	Exhaust 2 Transducer Signal Maximum	VOLTS			

BACnet Object Set	Description	Units			Notes
		LRC00	-LPS	-CMH	
Analog Value 128	Exhaust 2 Pitot Low Cal Flow	CFM	LPS	CMH	
Analog Value 129	Exhaust 2 Pitot Duct Area	FT <sup>2</sup>	M <sup>2</sup>	M <sup>2</sup>	
Analog Value 130	Exhaust 2 Pitot High Cal Flow	CFM	LPS	CMH	
Analog Value 132	Exhaust 2 Transducer Sensor Maximum	in. W.C.	Pa	Pa	
Analog Value 133	Supply 1 Room Temp Offset	°F	°C	°C	
Analog Value 134	Supply 2 Room Temp Offset	°F	°C	°C	
Analog Value 135	Supply 3 Room Temp Offset	°F	°C	°C	
Analog Value 136	Supply 4 Room Temp Offset	°F	°C	°C	
Analog Value 137	Supply 1 DAT Offset	°F	°C	°C	
Analog Value 138	Supply 2 DAT Offset	°F	°C	°C	
Analog Value 139	Supply 3 DAT Offset	°F	°C	°C	
Analog Value 140	Supply 4 DAT Offset	°F	°C	°C	
Analog Value 141	Supply 1 DAT Signal Minimum	VOLTS			
Analog Value 142	Supply 1 DAT Signal Maximum	VOLTS			
Analog Value 143	Supply 1 DAT Sensor Minimum	°F	°C	°C	
Analog Value 144	Supply 1 DAT Sensor Maximum	°F	°C	°C	
Analog Value 146	Supply 2 DAT Signal Minimum	VOLTS			
Analog Value 147	Supply 2 DAT Signal Maximum	VOLTS			
Analog Value 148	Supply 2 DAT Sensor Minimum	°F	°C	°C	
Analog Value 149	Supply 2 DAT Sensor Maximum	°F	°C	°C	
Analog Value 151	Supply 3 DAT Signal Minimum	VOLTS			
Analog Value 152	Supply 3 DAT Signal Maximum	VOLTS			
Analog Value 153	Supply 3 DAT Sensor Minimum	°F	°C	°C	
Analog Value 154	Supply 3 DAT Sensor Maximum	°F	°C	°C	
Analog Value 156	Supply 4 DAT Signal Minimum	VOLTS			
Analog Value 157	Supply 4 DAT Signal Maximum	VOLTS			
Analog Value 158	Supply 4 DAT Sensor Minimum	°F	°C	°C	
Analog Value 159	Supply 4 DAT Sensor Maximum	°F	°C	°C	
Analog Value 161	Supply 1 Room Temp Adj Signal Minimum	VOLTS			
Analog Value 162	Supply 1 Room Temp Adj Signal Maximum	VOLTS			
Analog Value 163	Supply 1 Room Temp Adj Sensor Minimum	°F	°C	°C	
Analog Value 164	Supply 1 Room Temp Adj Sensor Maximum	°F	°C	°C	
Analog Value 165	Supply 2 Room Temp Adj Signal Minimum	VOLTS			
Analog Value 166	Supply 2 Room Temp Adj Signal Maximum	VOLTS			
Analog Value 167	Supply 2 Room Temp Adj Sensor Minimum	°F	°C	°C	
Analog Value 168	Supply 2 Room Temp Adj Sensor Maximum	°F	°C	°C	
Analog Value 169	Supply 3 Room Temp Adj Signal Minimum	VOLTS			
Analog Value 170	Supply 3 Room Temp Adj Signal Maximum	VOLTS			
Analog Value 171	Supply 3 Room Temp Adj Sensor Minimum	°F	°C	°C	
Analog Value 172	Supply 3 Room Temp Adj Sensor Maximum	°F	°C	°C	
Analog Value 173	Supply 4 Room Temp Adj Signal Minimum	VOLTS			
Analog Value 174	Supply 4 Room Temp Adj Signal Maximum	VOLTS			
Analog Value 175	Supply 4 Room Temp Adj Sensor Minimum	°F	°C	°C	
Analog Value 176	Supply 4 Room Temp Adj Sensor Maximum	°F	°C	°C	

BACnet Object Set	Description	Units			Notes
		LRC00	-LPS	-CMH	
Analog Value 177	Relative Humidity Signal Minimum	VOLTS			
Analog Value 178	Relative Humidity Signal Maximum	VOLTS			
Analog Value 179	Relative Humidity Sensor Minimum	% RH			
Analog Value 180	Relative Humidity Sensor Maximum	% RH			
Analog Value 181	Relative Humidity Offset	% RH			
Analog Value 182	Pressure Transducer Signal Maximum	VOLTS			
Analog Value 183	Pressure Transducer Signal Minimum	VOLTS			
Analog Value 184	Pressure Transducer Sensor Minimum	in. W.C.	Pa	Pa	
Analog Value 185	Pressure Transducer Sensor Maximum	in. W.C.	Pa	Pa	
Analog Value 186	Room Pressure Sensor Zero	VOLTS			DO NOT OVERWRITE
Analog Value 188	TTW Sensor Velocity K-Factor				
Analog Value 189	TTW Sensor Elevation	FT	M	M	
Analog Value 190	Supply 1 Minimum Flow	CFM	LPS	CMH	
Analog Value 191	Supply 1 Cooling Flow	CFM	LPS	CMH	
Analog Value 192	Supply 1 Heating Flow	CFM	LPS	CMH	
Analog Value 193	Supply 1 Maximum Flow	CFM	LPS	CMH	
Analog Value 194	Supply 1 Minimum Position	% Open			
Analog Value 195	Supply 1 Maximum Position	% Open			
Analog Value 196	Supply 1 Unocc Minimum Flow	CFM	LPS	CMH	
Analog Value 197	Supply 1 Unocc Cooling Flow	CFM	LPS	CMH	
Analog Value 198	Supply 1 Unocc Heating Flow	CFM	LPS	CMH	
Analog Value 199	Supply 1 Unocc Maximum Flow	CFM	LPS	CMH	
Analog Value 200	Supply 1 Emergency Flow	CFM	LPS	CMH	
Analog Value 201	Supply 1 Shutdown Flow	CFM	LPS	CMH	
Analog Value 202	Supply 2 Minimum Flow	CFM	LPS	CMH	
Analog Value 203	Supply 2 Unocc Minimum Flow	CFM	LPS	CMH	
Analog Value 204	Supply 2 Cooling Flow	CFM	LPS	CMH	
Analog Value 205	Supply 2 Unocc Cooling Flow	CFM	LPS	CMH	
Analog Value 206	Supply 2 Heating Flow	CFM	LPS	CMH	
Analog Value 207	Supply 2 Unocc Heating Flow	CFM	LPS	CMH	
Analog Value 208	Supply 2 Maximum Flow	CFM	LPS	CMH	
Analog Value 209	Supply 2 Unocc Maximum Flow	CFM	LPS	CMH	
Analog Value 210	Supply 2 Emergency Flow	CFM	LPS	CMH	
Analog Value 211	Supply 2 Minimum Position	% Open			
Analog Value 212	Supply 2 Shutdown Flow	CFM	LPS	CMH	
Analog Value 213	Supply 2 Maximum Position	% Open			
Analog Value 214	Supply 3 Minimum Flow	CFM	LPS	CMH	
Analog Value 215	Supply 3 Unocc Minimum Flow	CFM	LPS	CMH	
Analog Value 216	Supply 3 Cooling Flow	CFM	LPS	CMH	
Analog Value 217	Supply 3 Unocc Cooling Flow	CFM	LPS	CMH	
Analog Value 218	Supply 3 Heating Flow	CFM	LPS	CMH	
Analog Value 219	Supply 3 Unocc Heating Flow	CFM	LPS	CMH	
Analog Value 220	Supply 3 Maximum Flow	CFM	LPS	CMH	
Analog Value 221	Supply 3 Unocc Maximum Flow	CFM	LPS	CMH	
Analog Value 222	Supply 3 Emergency Flow	CFM	LPS	CMH	
Analog Value 223	Supply 3 Minimum Position	% Open			



BACnet Object Set	Description	Units			Notes
		LRC00	-LPS	-CMH	
Analog Value 224	Supply 3 Shutdown Flow	CFM	LPS	CMH	
Analog Value 225	Supply 3 Maximum Position	% Open			
Analog Value 226	Supply 4 Minimum Flow	CFM	LPS	CMH	
Analog Value 227	Supply 4 Unocc Minimum Flow	CFM	LPS	CMH	
Analog Value 228	Supply 4 Cooling Flow	CFM	LPS	CMH	
Analog Value 229	Supply 4 Unocc Cooling Flow	CFM	LPS	CMH	
Analog Value 230	Supply 4 Heating Flow	CFM	LPS	CMH	
Analog Value 231	Supply 4 Unocc Heating Flow	CFM	LPS	CMH	
Analog Value 232	Supply 4 Maximum Flow	CFM	LPS	CMH	
Analog Value 233	Supply 4 Unocc Maximum Flow	CFM	LPS	CMH	
Analog Value 234	Supply 4 Emergency Flow	CFM	LPS	CMH	
Analog Value 235	Supply 4 Minimum Position	% Open			
Analog Value 236	Supply 4 Shutdown Flow	CFM	LPS	CMH	
Analog Value 237	Supply 4 Maximum Position	% Open			
Analog Value 238	Exhaust 1 Minimum Flow	CFM	LPS	CMH	
Analog Value 239	Exhaust 1 Maximum Flow	CFM	LPS	CMH	
Analog Value 240	Exhaust 1 Minimum Position	% Open			
Analog Value 241	Exhaust 1 Maximum Position	% Open			
Analog Value 242	Exhaust 1 Emergency Flow	CFM	LPS	CMH	
Analog Value 243	Exhaust 2 Minimum Flow	CFM	LPS	CMH	
Analog Value 244	Exhaust 2 Maximum Flow	CFM	LPS	CMH	
Analog Value 245	Exhaust 2 Minimum Position	% Open			
Analog Value 246	Exhaust 2 Maximum Position	% Open			
Analog Value 247	Exhaust 2 Emergency Flow	CFM	LPS	CMH	
Analog Value 248	Supply 1 Heat Setpoint	°F	°C	°C	
Analog Value 249	Supply 1 Cool Setpoint	°F	°C	°C	
Analog Value 250	Supply 1 Unocc Heat Setpoint	°F	°C	°C	
Analog Value 251	Supply 1 Unocc Cool Setpoint	°F	°C	°C	
Analog Value 252	Supply 1 DAT Delta	Δ°F	Δ °C	Δ °C	
Analog Value 253	Supply 2 Heat Setpoint	°F	°C	°C	
Analog Value 254	Supply 2 Cool Setpoint	°F	°C	°C	
Analog Value 255	Supply 2 Unocc Heat Setpoint	°F	°C	°C	
Analog Value 256	Supply 2 Unocc Cool Setpoint	°F	°C	°C	
Analog Value 257	Supply 2 DAT Delta	Δ°F	Δ °C	Δ °C	
Analog Value 258	Supply 3 Heat Setpoint	°F	°C	°C	
Analog Value 259	Supply 3 Cool Setpoint	°F	°C	°C	
Analog Value 260	Supply 3 Unocc Heat Setpoint	°F	°C	°C	
Analog Value 261	Supply 3 Unocc Cool Setpoint	°F	°C	°C	
Analog Value 262	Supply 3 DAT Delta	Δ°F	Δ °C	Δ °C	
Analog Value 263	Supply 4 Heat Setpoint	°F	°C	°C	
Analog Value 264	Supply 4 Cool Setpoint	°F	°C	°C	
Analog Value 265	Supply 4 Unocc Heat Setpoint	°F	°C	°C	
Analog Value 266	Supply 4 Unocc Cool Setpoint	°F	°C	°C	
Analog Value 267	Supply 4 DAT Delta	Δ°F	Δ °C	Δ °C	
Analog Value 268	Room Pressure Setpoint	in. W.C.	Pa	Pa	
Analog Value 269	Door Room Pressure Setpoint	in. W.C.	Pa	Pa	

BACnet Object Set		Units			Notes
Object	Description	LRC00	-LPS	-CMH	
Analog Value 270	Minimum Offset	CFM	LPS	CMH	
Analog Value 271	Maximum Offset	CFM	LPS	CMH	
Analog Value 272	Supply 1 Low Flow Alarm	CFM	LPS	CMH	
Analog Value 273	Supply 1 High Flow Alarm	CFM	LPS	CMH	
Analog Value 274	Supply 1 Unocc Low Flow Alarm	CFM	LPS	CMH	
Analog Value 275	Supply 1 Unocc High Flow Alarm	CFM	LPS	CMH	
Analog Value 276	Supply 2 Low Flow Alarm	CFM	LPS	CMH	
Analog Value 277	Supply 2 High Flow Alarm	CFM	LPS	CMH	
Analog Value 278	Supply 2 Unocc Low Flow Alarm	CFM	LPS	CMH	
Analog Value 279	Supply 2 Unocc High Flow Alarm	CFM	LPS	CMH	
Analog Value 280	Supply 3 Low Flow Alarm	CFM	LPS	CMH	
Analog Value 281	Supply 3 High Flow Alarm	CFM	LPS	CMH	
Analog Value 282	Supply 3 Unocc Low Flow Alarm	CFM	LPS	CMH	
Analog Value 283	Supply 3 Unocc High Flow Alarm	CFM	LPS	CMH	
Analog Value 284	Supply 4 Low Flow Alarm	CFM	LPS	CMH	
Analog Value 285	Supply 4 High Flow Alarm	CFM	LPS	CMH	
Analog Value 286	Supply 4 Unocc Low Flow Alarm	CFM	LPS	CMH	
Analog Value 287	Supply 4 Unocc High Flow Alarm	CFM	LPS	CMH	
Analog Value 288	Exhaust 1 Low Flow Alarm	CFM	LPS	CMH	
Analog Value 289	Exhaust 1 High Flow Alarm	CFM	LPS	CMH	
Analog Value 290	Exhaust 2 Low Flow Alarm	CFM	LPS	CMH	
Analog Value 291	Exhaust 2 High Flow Alarm	CFM	LPS	CMH	
Analog Value 292	Supply 1 Low Temperature Alarm	°F	°C	°C	
Analog Value 293	Supply 1 High Temperature Alarm	°F	°C	°C	
Analog Value 294	Supply 1 Unocc Low Temperature Alarm	°F	°C	°C	
Analog Value 295	Supply 1 Unocc High Temperature Alarm	°F	°C	°C	
Analog Value 296	Supply 2 Low Temperature Alarm	°F	°C	°C	
Analog Value 297	Supply 2 High Temperature Alarm	°F	°C	°C	
Analog Value 298	Supply 2 Unocc Low Temperature Alarm	°F	°C	°C	
Analog Value 299	Supply 2 Unocc High Temperature Alarm	°F	°C	°C	
Analog Value 300	Supply 3 Low Temperature Alarm	°F	°C	°C	
Analog Value 301	Supply 3 High Temperature Alarm	°F	°C	°C	
Analog Value 302	Supply 3 Unocc Low Temperature Alarm	°F	°C	°C	
Analog Value 303	Supply 3 Unocc High Temperature Alarm	°F	°C	°C	
Analog Value 304	Supply 4 Low Temperature Alarm	°F	°C	°C	
Analog Value 305	Supply 4 High Temperature Alarm	°F	°C	°C	
Analog Value 306	Supply 4 Unocc Low Temperature Alarm	°F	°C	°C	
Analog Value 307	Supply 4 Unocc High Temperature Alarm	°F	°C	°C	
Analog Value 308	Low Pressure Alarm	in. W.C.	Pa	Pa	
Analog Value 309	High Pressure Alarm	in. W.C.	Pa	Pa	
Analog Value 310	Door Low Pressure Alarm	in. W.C.	Pa	Pa	
Analog Value 311	Door High Pressure Alarm	in. W.C.	Pa	Pa	
Analog Value 312	Alarm Delay	SECONDS			
Analog Value 313	Door Alarm Delay	SECONDS			
Analog Value 314	Supply 1 Flow Manual Position	% Open			
Analog Value 315	Supply 2 Flow Manual Position	% Open			

BACnet Object Set	Description	Units			Notes
		LRC00	-LPS	-CMH	
Analog Value 316	Supply 3 Flow Manual Position	% Open			
Analog Value 317	Supply 4 Flow Manual Position	% Open			
Analog Value 318	Supply 1 Temp Manual Position	% Open			
Analog Value 319	Supply 2 Temp Manual Position	% Open			
Analog Value 320	Supply 3 Temp Manual Position	% Open			
Analog Value 321	Supply 4 Temp Manual Position	% Open			
Analog Value 322	Exhaust 1 Flow Manual Position	% Open			
Analog Value 323	Exhaust 2 Flow Manual Position	% Open			
Analog Value 324	Supply 5 Flow Manual Position	% Open			
Analog Value 325	Supply 6 Flow Manual Position	% Open			
Analog Value 326	Supply 1 Balancer Flow	CFM	LPS	CMH	
Analog Value 327	Supply 2 Balancer Flow	CFM	LPS	CMH	
Analog Value 328	Supply 3 Balancer Flow	CFM	LPS	CMH	
Analog Value 329	Supply 4 Balancer Flow	CFM	LPS	CMH	
Analog Value 330	Exhaust 1 Balancer Flow	CFM	LPS	CMH	
Analog Value 331	Exhaust 2 Balancer Flow	CFM	LPS	CMH	
Analog Value 332	Supply 1 High DAT Alarm	°F	°C	°C	
Analog Value 333	Supply 2 High DAT Alarm	°F	°C	°C	
Analog Value 334	Supply 3 High DAT Alarm	°F	°C	°C	
Analog Value 335	Supply 4 High DAT Alarm	°F	°C	°C	
Analog Value 336	Minimum Offset Alarm	CFM	LPS	CMH	
Analog Value 337	Maximum Offset Alarm	CFM	LPS	CMH	
Analog Value 338	Supply 1 Flow Input Number				DO NOT OVERWRITE
Analog Value 339	Supply 1 DAT Input Number				DO NOT OVERWRITE
Analog Value 340	Supply 1 Room Temp Input Number				DO NOT OVERWRITE
Analog Value 341	Supply 1 Room Temp Adj Input Number				DO NOT OVERWRITE
Analog Value 342	Supply 1 Occupancy Input Number				DO NOT OVERWRITE
Analog Value 343	Supply 2 Flow Input Number				DO NOT OVERWRITE
Analog Value 344	Supply 2 DAT Input Number				DO NOT OVERWRITE
Analog Value 345	Supply 2 Room Temp Input Number				DO NOT OVERWRITE
Analog Value 346	Supply 2 Room Temp Adj Input Number				DO NOT OVERWRITE
Analog Value 347	Supply 2 Occupancy Input Number				DO NOT OVERWRITE
Analog Value 348	Supply 3 Flow Input Number				DO NOT OVERWRITE
Analog Value 349	Supply 3 DAT Input Number				DO NOT OVERWRITE
Analog Value 350	Supply 3 Room Temp Input Number				DO NOT OVERWRITE
Analog Value 351	Supply 3 Room Temp Adj Input Number				DO NOT OVERWRITE
Analog Value 352	Supply 3 Occupancy Input Number				DO NOT OVERWRITE
Analog Value 353	Supply 4 Flow Input Number				DO NOT OVERWRITE
Analog Value 354	Supply 4 DAT Input Number				DO NOT OVERWRITE
Analog Value 355	Supply 4 Room Temp Input Number				DO NOT OVERWRITE
Analog Value 356	Supply 4 Room Temp Adj Input Number				DO NOT OVERWRITE
Analog Value 357	Supply 4 Occupancy Input Number				DO NOT OVERWRITE
Analog Value 358	Exhaust 1 Flow Input Number				DO NOT OVERWRITE
Analog Value 359	Exhaust 2 Flow Input Number				DO NOT OVERWRITE
Analog Value 360	Room Pressure Input Number				DO NOT OVERWRITE
Analog Value 361	Relative Humidity Input Number				DO NOT OVERWRITE

BACnet Object Set	Description	Units			Notes
		LRC00	-LPS	-CMH	
Analog Value 362	Door Switch Input Number				DO NOT OVERWRITE
Analog Value 363	Emergency Input Number				DO NOT OVERWRITE
Analog Value 364	Shutdown Input Number				DO NOT OVERWRITE
Analog Value 365	Hood 1 Flow Input Number				DO NOT OVERWRITE
Analog Value 366	Hood 2 Flow Input Number				DO NOT OVERWRITE
Analog Value 367	Hood 3 Flow Input Number				DO NOT OVERWRITE
Analog Value 368	Hood 4 Flow Input Number				DO NOT OVERWRITE
Analog Value 369	Hood 5 Flow Input Number				DO NOT OVERWRITE
Analog Value 370	Hood 6 Flow Input Number				DO NOT OVERWRITE
Analog Value 371	Hood 7 Flow Input Number				DO NOT OVERWRITE
Analog Value 372	Supply 1 Flow Change	CFM	LPS	CMH	
Analog Value 373	Supply 2 Flow Change	CFM	LPS	CMH	
Analog Value 374	Supply 3 Flow Change	CFM	LPS	CMH	
Analog Value 375	Supply 4 Flow Change	CFM	LPS	CMH	
Analog Value 376	Supply 1 Reheat/Cooling Delay	SECONDS			
Analog Value 377	Supply 2 Reheat/Cooling Delay	SECONDS			
Analog Value 378	Supply 3 Reheat/Cooling Delay	SECONDS			
Analog Value 379	Supply 4 Reheat/Cooling Delay	SECONDS			
Analog Value 384	Not applicable				
Analog Value 385					
Analog Value 386					
Analog Value 387					
Analog Value 388					
Analog Value 389					
Analog Value 390					
Analog Value 391					
Analog Value 392	Supply 5 Temp Manual Position	% Open			
Analog Value 393	Supply 6 Temp Manual Position	% Open			
Analog Value 395	Current Alarm Delay	SECONDS			DO NOT OVERWRITE
Analog Value 396	Current Offset	CFM	LPS	CMH	DO NOT OVERWRITE
Analog Value 398	Current Supply 1 Minimum Flow	CFM	LPS	CMH	DO NOT OVERWRITE
Analog Value 399	Current Supply 1 Cooling Flow	CFM	LPS	CMH	DO NOT OVERWRITE
Analog Value 400	Current Supply 1 Heating Flow	CFM	LPS	CMH	DO NOT OVERWRITE
Analog Value 401	Current Supply 1 Maximum Flow	CFM	LPS	CMH	DO NOT OVERWRITE
Analog Value 402	Current Supply 2 Minimum Flow	CFM	LPS	CMH	DO NOT OVERWRITE
Analog Value 403	Current Supply 2 Cooling Flow	CFM	LPS	CMH	DO NOT OVERWRITE
Analog Value 404	Current Supply 2 Heating Flow	CFM	LPS	CMH	DO NOT OVERWRITE
Analog Value 405	Current Supply 2 Maximum Flow	CFM	LPS	CMH	DO NOT OVERWRITE
Analog Value 406	Current Supply 3 Minimum Flow	CFM	LPS	CMH	DO NOT OVERWRITE
Analog Value 407	Current Supply 3 Cooling Flow	CFM	LPS	CMH	DO NOT OVERWRITE
Analog Value 408	Current Supply 3 Heating Flow	CFM	LPS	CMH	DO NOT OVERWRITE
Analog Value 409	Current Supply 3 Maximum Flow	CFM	LPS	CMH	DO NOT OVERWRITE
Analog Value 410	Current Supply 4 Minimum Flow	CFM	LPS	CMH	DO NOT OVERWRITE
Analog Value 411	Current Supply 4 Cooling Flow	CFM	LPS	CMH	DO NOT OVERWRITE
Analog Value 412	Current Supply 4 Heating Flow	CFM	LPS	CMH	DO NOT OVERWRITE
Analog Value 413	Current Supply 4 Maximum Flow	CFM	LPS	CMH	DO NOT OVERWRITE

BACnet Object Set	Description	Units			Notes
		LRC00	-LPS	-CMH	
Analog Value 414	Current Supply 1 Heat Setpoint	°F	°C	°C	DO NOT OVERWRITE
Analog Value 415	Current Supply 1 Cool Setpoint	°F	°C	°C	DO NOT OVERWRITE
Analog Value 416	Current Supply 2 Heat Setpoint	°F	°C	°C	DO NOT OVERWRITE
Analog Value 417	Current Supply 2 Cool Setpoint	°F	°C	°C	DO NOT OVERWRITE
Analog Value 418	Current Supply 3 Heat Setpoint	°F	°C	°C	DO NOT OVERWRITE
Analog Value 419	Current Supply 3 Cool Setpoint	°F	°C	°C	DO NOT OVERWRITE
Analog Value 420	Current Supply 4 Heat Setpoint	°F	°C	°C	DO NOT OVERWRITE
Analog Value 421	Current Supply 4 Cool Setpoint	°F	°C	°C	DO NOT OVERWRITE
Analog Value 422	Current Room Pressure Setpoint	in. W.C.	Pa	Pa	DO NOT OVERWRITE
Analog Value 423	Current Supply 1 Low Flow Alarm	CFM	LPS	CMH	DO NOT OVERWRITE
Analog Value 424	Current Supply 1 High Flow Alarm	CFM	LPS	CMH	DO NOT OVERWRITE
Analog Value 425	Current Supply 2 Low Flow Alarm	CFM	LPS	CMH	DO NOT OVERWRITE
Analog Value 426	Current Supply 2 High Flow Alarm	CFM	LPS	CMH	DO NOT OVERWRITE
Analog Value 427	Current Supply 3 Low Flow Alarm	CFM	LPS	CMH	DO NOT OVERWRITE
Analog Value 428	Current Supply 3 High Flow Alarm	CFM	LPS	CMH	DO NOT OVERWRITE
Analog Value 429	Current Supply 4 Low Flow Alarm	CFM	LPS	CMH	DO NOT OVERWRITE
Analog Value 430	Current Supply 4 High Flow Alarm	CFM	LPS	CMH	DO NOT OVERWRITE
Analog Value 431	Current Low Pressure Alarm	in. W.C.	Pa	Pa	DO NOT OVERWRITE
Analog Value 432	Current High Pressure Alarm	in. W.C.	Pa	Pa	DO NOT OVERWRITE
Analog Value 433	Current Supply 1 Low Temperature Alarm	°F	°C	°C	DO NOT OVERWRITE
Analog Value 434	Current Supply 1 High Temperature Alarm	°F	°C	°C	DO NOT OVERWRITE
Analog Value 435	Current Supply 2 Low Temperature Alarm	°F	°C	°C	DO NOT OVERWRITE
Analog Value 436	Current Supply 2 High Temperature Alarm	°F	°C	°C	DO NOT OVERWRITE
Analog Value 437	Current Supply 3 Low Temperature Alarm	°F	°C	°C	DO NOT OVERWRITE
Analog Value 438	Current Supply 3 High Temperature Alarm	°F	°C	°C	DO NOT OVERWRITE
Analog Value 439	Current Supply 4 Low Temperature Alarm	°F	°C	°C	DO NOT OVERWRITE
Analog Value 440	Current Supply 4 High Temperature Alarm	°F	°C	°C	DO NOT OVERWRITE
Analog Value 441	Hood 1 Venturi Minimum Flow	CFM	LPS	CMH	
Analog Value 442	Hood 1 Venturi Maximum Flow	CFM	LPS	CMH	
Analog Value 443	Hood 1 Flow K factor				
Analog Value 445	Hood 1 Venturi LOM ESC Time	SECONDS			
Analog Value 446	Hood 1 Linear Duct Area	FT <sup>2</sup>	M <sup>2</sup>	M <sup>2</sup>	
Analog Value 448	Hood 1 Linear Top Velocity	FT/MIN	M/S	M/S	
Analog Value 449	Hood 1 Linear Signal Minimum	VOLTS			
Analog Value 450	Hood 1 Linear Signal Maximum	VOLTS			
Analog Value 451	Hood 1 Pitot Sensor Zero	VOLTS			DO NOT OVERWRITE
Analog Value 452	Hood 1 Transducer Signal Minimum	VOLTS			
Analog Value 453	Hood 1 Transducer Signal Maximum	VOLTS			
Analog Value 454	Hood 1 Pitot Duct Area	FT <sup>2</sup>	M <sup>2</sup>	M <sup>2</sup>	
Analog Value 456	Hood 1 Transducer Sensor Maximum	in. W.C.	Pa	Pa	
Analog Value 459	Hood 1 Pitot Low Cal Flow	CFM	LPS	CMH	
Analog Value 460	Hood 1 Pitot High Cal Flow	CFM	LPS	CMH	
Analog Value 461	Hood 1 Pitot Low Cal Voltage	VOLTS			DO NOT OVERWRITE
Analog Value 462	Hood 1 Pitot High Cal Voltage	VOLTS			DO NOT OVERWRITE
Analog Value 463	Hood 1 TP Min Flow	CFM	LPS	CMH	
Analog Value 464	Hood 1 TP Max Flow	CFM	LPS	CMH	

BACnet Object Set	Description	Units			Notes
		LRC00	-LPS	-CMH	
Analog Value 465	Hood 2 Venturi Minimum Flow	CFM	LPS	CMH	
Analog Value 466	Hood 2 Venturi Maximum Flow	CFM	LPS	CMH	
Analog Value 467	Hood 2 Flow K factor				
Analog Value 469	Hood 2 Venturi LOM ESC Time	SECONDS			
Analog Value 470	Hood 2 Linear Duct Area	FT <sup>2</sup>	M <sup>2</sup>	M <sup>2</sup>	
Analog Value 472	Hood 2 Linear Top Velocity	FT/MIN	M/S	M/S	
Analog Value 473	Hood 2 Linear Signal Minimum	VOLTS			
Analog Value 474	Hood 2 Linear Signal Maximum	VOLTS			
Analog Value 475	Hood 2 Pitot Sensor Zero	VOLTS			DO NOT OVERWRITE
Analog Value 476	Hood 2 Transducer Signal Minimum	VOLTS			
Analog Value 477	Hood 2 Transducer Signal Maximum	VOLTS			
Analog Value 478	Hood 2 Pitot Duct Area	FT <sup>2</sup>	M <sup>2</sup>	M <sup>2</sup>	
Analog Value 480	Hood 2 Transducer Sensor Maximum	in. W.C.	Pa	Pa	
Analog Value 483	Hood 2 Pitot Low Cal Flow	CFM	LPS	CMH	
Analog Value 484	Hood 2 Pitot High Cal Flow	CFM	LPS	CMH	
Analog Value 485	Hood 2 Pitot Low Cal Voltage	VOLTS			DO NOT OVERWRITE
Analog Value 486	Hood 2 Pitot High Cal Voltage	VOLTS			DO NOT OVERWRITE
Analog Value 487	Hood 2 TP Min Flow	CFM	LPS	CMH	
Analog Value 488	Hood 2 TP Max Flow	CFM	LPS	CMH	
Analog Value 489	Hood 3 Venturi Minimum Flow	CFM	LPS	CMH	
Analog Value 490	Hood 3 Venturi Maximum Flow	CFM	LPS	CMH	
Analog Value 491	Hood 3 Flow K factor				
Analog Value 493	Hood 3 Venturi LOM ESC Time	SECONDS			
Analog Value 494	Hood 3 Linear Duct Area	FT <sup>2</sup>	M <sup>2</sup>	M <sup>2</sup>	
Analog Value 496	Hood 3 Linear Top Velocity	FT/MIN	M/S	M/S	
Analog Value 497	Hood 3 Linear Signal Minimum	VOLTS			
Analog Value 498	Hood 3 Linear Signal Maximum	VOLTS			
Analog Value 499	Hood 3 Pitot Sensor Zero	VOLTS			DO NOT OVERWRITE
Analog Value 500	Hood 3 Transducer Signal Minimum	VOLTS			
Analog Value 501	Hood 3 Transducer Signal Maximum	VOLTS			
Analog Value 502	Hood 3 Pitot Duct Area	FT <sup>2</sup>	M <sup>2</sup>	M <sup>2</sup>	
Analog Value 504	Hood 3 Transducer Sensor Maximum	in. W.C.	Pa	Pa	
Analog Value 507	Hood 3 Pitot Low Cal Flow	CFM	LPS	CMH	
Analog Value 508	Hood 3 Pitot High Cal Flow	CFM	LPS	CMH	
Analog Value 509	Hood 3 Pitot Low Cal Voltage	VOLTS			DO NOT OVERWRITE
Analog Value 510	Hood 3 Pitot High Cal Voltage	VOLTS			DO NOT OVERWRITE
Analog Value 511	Hood 3 TP Min Flow	CFM	LPS	CMH	
Analog Value 512	Hood 3 TP Max Flow	CFM	LPS	CMH	
Analog Value 513	Hood 4 Venturi Minimum Flow	CFM	LPS	CMH	
Analog Value 514	Hood 4 Venturi Maximum Flow	CFM	LPS	CMH	
Analog Value 515	Hood 4 Flow K factor				
Analog Value 517	Hood 4 Venturi LOM ESC Time	SECONDS			
Analog Value 518	Hood 4 Linear Duct Area	FT <sup>2</sup>	M <sup>2</sup>	M <sup>2</sup>	
Analog Value 520	Hood 4 Linear Top Velocity	FT/MIN	M/S	M/S	
Analog Value 521	Hood 4 Linear Signal Minimum	VOLTS			
Analog Value 522	Hood 4 Linear Signal Maximum	VOLTS			

BACnet Object Set	Object	Description	Units			Notes
			LRC00	-LPS	-CMH	
Analog Value 523	Hood 4 Pitot Sensor Zero	VOLTS				DO NOT OVERWRITE
Analog Value 524	Hood 4 Transducer Signal Minimum	VOLTS				
Analog Value 525	Hood 4 Transducer Signal Maximum	VOLTS				
Analog Value 526	Hood 4 Pitot Duct Area	FT <sup>2</sup>	M <sup>2</sup>	M <sup>2</sup>		
Analog Value 528	Hood 4 Transducer Sensor Maximum	in. W.C.	Pa	Pa		
Analog Value 531	Hood 4 Pitot Low Cal Flow	CFM	LPS	CMH		
Analog Value 532	Hood 4 Pitot High Cal Flow	CFM	LPS	CMH		
Analog Value 533	Hood 4 Pitot Low Cal Voltage	VOLTS				DO NOT OVERWRITE
Analog Value 534	Hood 4 Pitot High Cal Voltage	VOLTS				DO NOT OVERWRITE
Analog Value 535	Hood 4 TP Min Flow	CFM	LPS	CMH		
Analog Value 536	Hood 4 TP Max Flow	CFM	LPS	CMH		
Analog Value 537	Hood 5 Venturi Minimum Flow	CFM	LPS	CMH		
Analog Value 538	Hood 5 Venturi Maximum Flow	CFM	LPS	CMH		
Analog Value 539	Hood 5 Flow K factor					
Analog Value 541	Hood 5 Venturi LOM ESC Time	SECONDS				
Analog Value 542	Hood 5 Linear Duct Area	FT <sup>2</sup>	M <sup>2</sup>	M <sup>2</sup>		
Analog Value 544	Hood 5 Linear Top Velocity	FT/MIN	M/S	M/S		
Analog Value 545	Hood 5 Linear Signal Minimum	VOLTS				
Analog Value 546	Hood 5 Linear Signal Maximum	VOLTS				
Analog Value 547	Hood 5 Pitot Sensor Zero	VOLTS				DO NOT OVERWRITE
Analog Value 548	Hood 5 Transducer Signal Minimum	VOLTS				
Analog Value 549	Hood 5 Transducer Signal Maximum	VOLTS				
Analog Value 550	Hood 5 Pitot Duct Area	FT <sup>2</sup>	M <sup>2</sup>	M <sup>2</sup>		
Analog Value 552	Hood 5 Transducer Sensor Maximum	in. W.C.	Pa	Pa		
Analog Value 555	Hood 5 Pitot Low Cal Flow	CFM	LPS	CMH		
Analog Value 556	Hood 5 Pitot High Cal Flow	CFM	LPS	CMH		
Analog Value 557	Hood 5 Pitot Low Cal Voltage	VOLTS				DO NOT OVERWRITE
Analog Value 558	Hood 5 Pitot High Cal Voltage	VOLTS				DO NOT OVERWRITE
Analog Value 559	Hood 5 TP Min Flow	CFM	LPS	CMH		
Analog Value 560	Hood 5 TP Max Flow	CFM	LPS	CMH		
Analog Value 561	Hood 6 Venturi Minimum Flow	CFM	LPS	CMH		
Analog Value 562	Hood 6 Venturi Maximum Flow	CFM	LPS	CMH		
Analog Value 563	Hood 6 Flow K factor					
Analog Value 565	Hood 6 Venturi LOM ESC Time	SECONDS				
Analog Value 566	Hood 6 Linear Duct Area	FT <sup>2</sup>	M <sup>2</sup>	M <sup>2</sup>		
Analog Value 568	Hood 6 Linear Top Velocity	FT/MIN	M/S	M/S		
Analog Value 569	Hood 6 Linear Signal Minimum	VOLTS				
Analog Value 570	Hood 6 Linear Signal Maximum	VOLTS				
Analog Value 571	Hood 6 Pitot Sensor Zero	VOLTS				DO NOT OVERWRITE
Analog Value 572	Hood 6 Transducer Signal Minimum	VOLTS				
Analog Value 573	Hood 6 Transducer Signal Maximum	VOLTS				
Analog Value 574	Hood 6 Pitot Duct Area	FT <sup>2</sup>	M <sup>2</sup>	M <sup>2</sup>		
Analog Value 576	Hood 6 Transducer Sensor Maximum	in. W.C.	Pa	Pa		
Analog Value 579	Hood 6 Pitot Low Cal Flow	CFM	LPS	CMH		
Analog Value 580	Hood 6 Pitot High Cal Flow	CFM	LPS	CMH		
Analog Value 581	Hood 6 Pitot Low Cal Voltage	VOLTS				DO NOT OVERWRITE

BACnet Object Set	Description	Units			Notes
		LRC00	-LPS	-CMH	
Analog Value 582	Hood 6 Pitot High Cal Voltage	VOLTS			DO NOT OVERWRITE
Analog Value 583	Hood 6 TP Min Flow	CFM	LPS	CMH	
Analog Value 584	Hood 6 TP Max Flow	CFM	LPS	CMH	
Analog Value 585	Hood 7 Venturi Minimum Flow	CFM	LPS	CMH	
Analog Value 586	Hood 7 Venturi Maximum Flow	CFM	LPS	CMH	
Analog Value 587	Hood 7 Flow K factor				
Analog Value 589	Hood 7 Venturi LOM ESC Time	SECONDS			
Analog Value 590	Hood 7 Linear Duct Area	FT <sup>2</sup>	M <sup>2</sup>	M <sup>2</sup>	
Analog Value 592	Hood 7 Linear Top Velocity	FT/MIN	M/S	M/S	
Analog Value 593	Hood 7 Linear Signal Minimum	VOLTS			
Analog Value 594	Hood 7 Linear Signal Maximum	VOLTS			
Analog Value 595	Hood 7 Pitot Sensor Zero	VOLTS			DO NOT OVERWRITE
Analog Value 596	Hood 7 Transducer Signal Minimum	VOLTS			
Analog Value 597	Hood 7 Transducer Signal Maximum	VOLTS			
Analog Value 598	Hood 7 Pitot Duct Area	FT <sup>2</sup>	M <sup>2</sup>	M <sup>2</sup>	
Analog Value 600	Hood 7 Transducer Sensor Maximum	in. W.C.	Pa	Pa	
Analog Value 603	Hood 7 Pitot Low Cal Flow	CFM	LPS	CMH	
Analog Value 604	Hood 7 Pitot High Cal Flow	CFM	LPS	CMH	
Analog Value 605	Hood 7 Pitot Low Cal Voltage	VOLTS			DO NOT OVERWRITE
Analog Value 606	Hood 7 Pitot High Cal Voltage	VOLTS			DO NOT OVERWRITE
Analog Value 607	Hood 7 TP Min Flow	CFM	LPS	CMH	
Analog Value 608	Hood 7 TP Max Flow	CFM	LPS	CMH	
Analog Value 609	Hood 1 Pitot Uncal Low Cal Flow	CFM	LPS	CMH	DO NOT OVERWRITE
Analog Value 610	Hood 1 Pitot Uncal High Cal Flow	CFM	LPS	CMH	DO NOT OVERWRITE
Analog Value 611	Hood 2 Pitot Uncal Low Cal Flow	CFM	LPS	CMH	DO NOT OVERWRITE
Analog Value 612	Hood 2 Pitot Uncal High Cal Flow	CFM	LPS	CMH	DO NOT OVERWRITE
Analog Value 613	Hood 3 Pitot Uncal Low Cal Flow	CFM	LPS	CMH	DO NOT OVERWRITE
Analog Value 614	Hood 3 Pitot Uncal High Cal Flow	CFM	LPS	CMH	DO NOT OVERWRITE
Analog Value 615	Hood 4 Pitot Uncal Low Cal Flow	CFM	LPS	CMH	DO NOT OVERWRITE
Analog Value 616	Hood 4 Pitot Uncal High Cal Flow	CFM	LPS	CMH	DO NOT OVERWRITE
Analog Value 617	Hood 5 Pitot Uncal Low Cal Flow	CFM	LPS	CMH	DO NOT OVERWRITE
Analog Value 618	Hood 5 Pitot Uncal High Cal Flow	CFM	LPS	CMH	DO NOT OVERWRITE
Analog Value 619	Hood 6 Pitot Uncal Low Cal Flow	CFM	LPS	CMH	DO NOT OVERWRITE
Analog Value 620	Hood 6 Pitot Uncal High Cal Flow	CFM	LPS	CMH	DO NOT OVERWRITE
Analog Value 621	Hood 7 Pitot Uncal Low Cal Flow	CFM	LPS	CMH	DO NOT OVERWRITE
Analog Value 622	Hood 7 Pitot Uncal High Cal Flow	CFM	LPS	CMH	DO NOT OVERWRITE
Analog Value 623	TTW Sensor UnSpanned Velocity	FT/MIN	M/S	M/S	DO NOT OVERWRITE
Analog Value 624	TTW Sensor Spanned Velocity	FT/MIN	M/S	M/S	DO NOT OVERWRITE
Analog Value 625	Supply 1 Pitot Low Cal Voltage	VOLTS			DO NOT OVERWRITE
Analog Value 626	Supply 1 Pitot High Cal Voltage	VOLTS			DO NOT OVERWRITE
Analog Value 627	Supply 2 Pitot Low Cal Voltage	VOLTS			DO NOT OVERWRITE
Analog Value 628	Supply 2 Pitot High Cal Voltage	VOLTS			DO NOT OVERWRITE
Analog Value 629	Supply 3 Pitot Low Cal Voltage	VOLTS			DO NOT OVERWRITE
Analog Value 630	Supply 3 Pitot High Cal Voltage	VOLTS			DO NOT OVERWRITE
Analog Value 631	Supply 4 Pitot Low Cal Voltage	VOLTS			DO NOT OVERWRITE
Analog Value 632	Supply 4 Pitot High Cal Voltage	VOLTS			DO NOT OVERWRITE



BACnet Object Set	Object	Description	Units			Notes
			LRC00	-LPS	-CMH	
Analog Value 633		Exhaust 1 Pitot Low Cal Voltage	VOLTS			DO NOT OVERWRITE
Analog Value 634		Exhaust 1 Pitot High Cal Voltage	VOLTS			DO NOT OVERWRITE
Analog Value 635		Exhaust 2 Pitot Low Cal Voltage	VOLTS			DO NOT OVERWRITE
Analog Value 636		Exhaust 2 Pitot High Cal Voltage	VOLTS			DO NOT OVERWRITE
Analog Value 653		Supply 5 Balancer Flow	CFM	LPS	CMH	
Analog Value 654		Supply 6 Balancer Flow	CFM	LPS	CMH	
Analog Value 655		Current Supply 1 Minimum Flow Setpoint	CFM	LPS	CMH	DO NOT OVERWRITE
Analog Value 656		Current Supply 2 Minimum Flow Setpoint	CFM	LPS	CMH	DO NOT OVERWRITE
Analog Value 657		Current Supply 3 Minimum Flow Setpoint	CFM	LPS	CMH	DO NOT OVERWRITE
Analog Value 658		Current Supply 4 Minimum Flow Setpoint	CFM	LPS	CMH	DO NOT OVERWRITE
Analog Value 659		Offset Setpoint	CFM	LPS	CMH	DO NOT OVERWRITE
Analog Value 660		Current Total Supply Flow	CFM	LPS	CMH	DO NOT OVERWRITE
Analog Value 661		Current Total Exhaust Flow	CFM	LPS	CMH	DO NOT OVERWRITE
Analog Value 662		Supply 1 Flow	CFM	LPS	CMH	DO NOT OVERWRITE
Analog Value 663		Supply 2 Flow	CFM	LPS	CMH	DO NOT OVERWRITE
Analog Value 664		Supply 3 Flow	CFM	LPS	CMH	DO NOT OVERWRITE
Analog Value 665		Supply 4 Flow	CFM	LPS	CMH	DO NOT OVERWRITE
Analog Value 666		Exhaust 1 Flow	CFM	LPS	CMH	DO NOT OVERWRITE
Analog Value 667		Exhaust 2 Flow	CFM	LPS	CMH	DO NOT OVERWRITE
Analog Value 668		Hood 1 Flow	CFM	LPS	CMH	DO NOT OVERWRITE
Analog Value 669		Hood 2 Flow	CFM	LPS	CMH	DO NOT OVERWRITE
Analog Value 670		Hood 3 Flow	CFM	LPS	CMH	DO NOT OVERWRITE
Analog Value 671		Hood 4 Flow	CFM	LPS	CMH	DO NOT OVERWRITE
Analog Value 672		Hood 5 Flow	CFM	LPS	CMH	DO NOT OVERWRITE
Analog Value 673		Hood 6 Flow	CFM	LPS	CMH	DO NOT OVERWRITE
Analog Value 674		Hood 7 Flow	CFM	LPS	CMH	DO NOT OVERWRITE
Analog Value 675		Current Supply 1 Temperature Control Position	% Open			DO NOT OVERWRITE
Analog Value 676		Current Supply 1 Flow Control Position	% Open			DO NOT OVERWRITE
Analog Value 677		Current Supply 2 Temperature Control Position	% Open			DO NOT OVERWRITE
Analog Value 678		Current Supply 2 Flow Control Position	% Open			DO NOT OVERWRITE
Analog Value 679		Current Supply 3 Temperature Control Position	% Open			DO NOT OVERWRITE
Analog Value 680		Current Supply 3 Flow Control Position	% Open			DO NOT OVERWRITE
Analog Value 681		Current Supply 4 Temperature Control Position	% Open			DO NOT OVERWRITE
Analog Value 682		Current Supply 4 Flow Control Position	% Open			DO NOT OVERWRITE
Analog Value 683		Current Exhaust 1 Flow Control Position	% Open			DO NOT OVERWRITE
Analog Value 684		Current Exhaust 2 Flow Control Position	% Open			DO NOT OVERWRITE
Analog Value 685		Supply 1 DAT	°F	°C	°C	DO NOT OVERWRITE
Analog Value 686		Supply 2 DAT	°F	°C	°C	DO NOT OVERWRITE
Analog Value 687		Supply 3 DAT	°F	°C	°C	DO NOT OVERWRITE
Analog Value 688		Supply 4 DAT	°F	°C	°C	DO NOT OVERWRITE
Analog Value 689		Supply 1 Room Temp	°F	°C	°C	DO NOT OVERWRITE
Analog Value 690		Supply 2 Room Temp	°F	°C	°C	DO NOT OVERWRITE
Analog Value 691		Supply 3 Room Temp	°F	°C	°C	DO NOT OVERWRITE

BACnet Object Set	Description	Units			Notes
		LRC00	-LPS	-CMH	
Analog Value 692	Supply 4 Room Temp	°F	°C	°C	DO NOT OVERWRITE
Analog Value 693	Supply 1 Room Temp Adj	°F	°C	°C	DO NOT OVERWRITE
Analog Value 694	Supply 2 Room Temp Adj	°F	°C	°C	DO NOT OVERWRITE
Analog Value 695	Supply 3 Room Temp Adj	°F	°C	°C	DO NOT OVERWRITE
Analog Value 696	Supply 4 Room Temp Adj	°F	°C	°C	DO NOT OVERWRITE
Analog Value 697	Room Pressure	in. W.C.	Pa	Pa	DO NOT OVERWRITE
Analog Value 698	Relative Humidity	% RH			DO NOT OVERWRITE
Analog Value 699	Hood 8 Flow Input Number				DO NOT OVERWRITE
Analog Value 700	Hood 9 Flow Input Number				DO NOT OVERWRITE
Analog Value 701	Hood 10 Flow Input Number				DO NOT OVERWRITE
Analog Value 702	Hood 11 Flow Input Number				DO NOT OVERWRITE
Analog Value 703	Hood 12 Flow Input Number				DO NOT OVERWRITE
Analog Value 704	Hood 13 Flow Input Number				DO NOT OVERWRITE
Analog Value 705	Hood 14 Flow Input Number				DO NOT OVERWRITE
Analog Value 706	Hood 15 Flow Input Number				DO NOT OVERWRITE
Analog Value 707	Hood 16 Flow Input Number				DO NOT OVERWRITE
Analog Value 708	Hood 17 Flow Input Number				DO NOT OVERWRITE
Analog Value 709	Hood 18 Flow Input Number				DO NOT OVERWRITE
Analog Value 710	Hood 19 Flow Input Number				DO NOT OVERWRITE
Analog Value 711	Hood 20 Flow Input Number				DO NOT OVERWRITE
Analog Value 713	Supply 1 Flow Voltage	VOLTS			DO NOT OVERWRITE
Analog Value 714	Supply 2 Flow Voltage	VOLTS			DO NOT OVERWRITE
Analog Value 715	Supply 3 Flow Voltage	VOLTS			DO NOT OVERWRITE
Analog Value 716	Supply 4 Flow Voltage	VOLTS			DO NOT OVERWRITE
Analog Value 717	Exhaust 1 Flow Voltage	VOLTS			DO NOT OVERWRITE
Analog Value 718	Exhaust 2 Flow Voltage	VOLTS			DO NOT OVERWRITE
Analog Value 719	Hood 1 Flow Voltage	VOLTS			DO NOT OVERWRITE
Analog Value 720	Hood 2 Flow Voltage	VOLTS			DO NOT OVERWRITE
Analog Value 721	Hood 3 Flow Voltage	VOLTS			DO NOT OVERWRITE
Analog Value 722	Hood 4 Flow Voltage	VOLTS			DO NOT OVERWRITE
Analog Value 723	Hood 5 Flow Voltage	VOLTS			DO NOT OVERWRITE
Analog Value 724	Hood 6 Flow Voltage	VOLTS			DO NOT OVERWRITE
Analog Value 725	Hood 7 Flow Voltage	VOLTS			DO NOT OVERWRITE
Analog Value 726	Supply 1 DAT Voltage	VOLTS			DO NOT OVERWRITE
Analog Value 727	Supply 2 DAT Voltage	VOLTS			DO NOT OVERWRITE
Analog Value 728	Supply 3 DAT Voltage	VOLTS			DO NOT OVERWRITE
Analog Value 729	Supply 4 DAT Voltage	VOLTS			DO NOT OVERWRITE
Analog Value 730	Room Pressure Voltage	VOLTS			DO NOT OVERWRITE
Analog Value 731	Relative Humidity Voltage	VOLTS			DO NOT OVERWRITE
Analog Value 732	Supply 1 Room Temp Adjustment Voltage	VOLTS			DO NOT OVERWRITE
Analog Value 733	Supply 2 Room Temp Adjustment Voltage	VOLTS			DO NOT OVERWRITE
Analog Value 734	Supply 3 Room Temp Adjustment Voltage	VOLTS			DO NOT OVERWRITE
Analog Value 735	Supply 4 Room Temp Adjustment Voltage	VOLTS			DO NOT OVERWRITE
Analog Value 736	Supply 1 Flow Proportional Gain				
Analog Value 737	Supply 2 Flow Proportional Gain				
Analog Value 738	Supply 3 Flow Proportional Gain				

BACnet Object Set	Description	Units			Notes
		LRC00	-LPS	-CMH	
Analog Value 739	Supply 4 Flow Proportional Gain				
Analog Value 740	Exhaust 1 Flow Proportional Gain				
Analog Value 741	Exhaust 2 Flow Proportional Gain				
Analog Value 742	Supply 1 Flow Integral Time				
Analog Value 743	Supply 2 Flow Integral Time				
Analog Value 744	Supply 3 Flow Integral Time				
Analog Value 745	Supply 4 Flow Integral Time				
Analog Value 746	Exhaust 1 Flow Integral Time				
Analog Value 747	Exhaust 2 Flow Integral Time				
Analog Value 748	Pressure Control Gain				
Analog Value 749	Supply 1 Temp Throttling Range	°F	°C	°C	
Analog Value 750	Supply 2 Temp Throttling Range	°F	°C	°C	
Analog Value 751	Supply 3 Temp Throttling Range	°F	°C	°C	
Analog Value 752	Supply 4 Temp Throttling Range	°F	°C	°C	
Analog Value 753	Supply 1 Temp Integral Time	SECONDS			
Analog Value 754	Supply 2 Temp Integral Time	SECONDS			
Analog Value 755	Supply 3 Temp Integral Time	SECONDS			
Analog Value 756	Supply 4 Temp Integral Time	SECONDS			
Analog Value 757	Supply 1 Flow Speed	%			
Analog Value 758	Supply 2 Flow Speed	%			
Analog Value 759	Supply 3 Flow Speed	%			
Analog Value 760	Supply 4 Flow Speed	%			
Analog Value 761	Exhaust 1 Flow Speed	%			
Analog Value 762	Exhaust 2 Flow Speed	%			
Analog Value 763	Supply 1 Flow Sensitivity	%			
Analog Value 764	Supply 2 Flow Sensitivity	%			
Analog Value 765	Supply 3 Flow Sensitivity	%			
Analog Value 766	Supply 4 Flow Sensitivity	%			
Analog Value 767	Exhaust 1 Flow Sensitivity	%			
Analog Value 768	Exhaust 2 Flow Sensitivity	%			
Analog Value 769	Supply 1 Shutdown Low Flow Alarm	CFM	LPS	CMH	
Analog Value 770	Supply 1 Shutdown High Flow Alarm	CFM	LPS	CMH	
Analog Value 771	Supply 2 Shutdown Low Flow Alarm	CFM	LPS	CMH	
Analog Value 772	Supply 2 Shutdown High Flow Alarm	CFM	LPS	CMH	
Analog Value 773	Supply 3 Shutdown Low Flow Alarm	CFM	LPS	CMH	
Analog Value 774	Supply 3 Shutdown High Flow Alarm	CFM	LPS	CMH	
Analog Value 775	Supply 4 Shutdown Low Flow Alarm	CFM	LPS	CMH	
Analog Value 776	Supply 4 Shutdown High Flow Alarm	CFM	LPS	CMH	
Analog Value 777	Exhaust 1 Shutdown Low Flow Alarm	CFM	LPS	CMH	
Analog Value 778	Exhaust 1 Shutdown High Flow Alarm	CFM	LPS	CMH	
Analog Value 779	Exhaust 2 Shutdown Low Flow Alarm	CFM	LPS	CMH	
Analog Value 780	Exhaust 2 Shutdown High Flow Alarm	CFM	LPS	CMH	
Analog Value 781	Exhaust 1 Unocc Low Flow Alarm	CFM	LPS	CMH	
Analog Value 782	Exhaust 1 Unocc High Flow Alarm	CFM	LPS	CMH	
Analog Value 783	Exhaust 2 Unocc Low Flow Alarm	CFM	LPS	CMH	
Analog Value 784	Exhaust 2 Unocc High Flow Alarm	CFM	LPS	CMH	

BACnet Object Set	Description	Units			Notes
		LRC00	-LPS	-CMH	
Analog Value 785	Current Exhaust 1 Low Flow Alarm	CFM	LPS	CMH	
Analog Value 786	Current Exhaust 1 High Flow Alarm	CFM	LPS	CMH	
Analog Value 787	Current Exhaust 2 Low Flow Alarm	CFM	LPS	CMH	
Analog Value 788	Current Exhaust 2 High Flow Alarm	CFM	LPS	CMH	
Analog Value 789	Hood 8 Flow	CFM	LPS	CMH	
Analog Value 790	Hood 9 Flow	CFM	LPS	CMH	
Analog Value 791	Hood 10 Flow	CFM	LPS	CMH	
Analog Value 792	Hood 11 Flow	CFM	LPS	CMH	
Analog Value 793	Hood 12 Flow	CFM	LPS	CMH	
Analog Value 794	Hood 13 Flow	CFM	LPS	CMH	
Analog Value 795	Hood 14 Flow	CFM	LPS	CMH	
Analog Value 796	Hood 15 Flow	CFM	LPS	CMH	
Analog Value 797	Hood 16 Flow	CFM	LPS	CMH	
Analog Value 798	Hood 17 Flow	CFM	LPS	CMH	
Analog Value 799	Hood 18 Flow	CFM	LPS	CMH	
Analog Value 800	Hood 19 Flow	CFM	LPS	CMH	
Analog Value 801	Hood 20 Flow	CFM	LPS	CMH	
Analog Value 802	Hood 8 Flow Voltage	VOLTS			DO NOT OVERWRITE
Analog Value 803	Hood 9 Flow Voltage	VOLTS			DO NOT OVERWRITE
Analog Value 804	Hood 10 Flow Voltage	VOLTS			DO NOT OVERWRITE
Analog Value 805	Hood 11 Flow Voltage	VOLTS			DO NOT OVERWRITE
Analog Value 806	Hood 12 Flow Voltage	VOLTS			DO NOT OVERWRITE
Analog Value 807	Hood 13 Flow Voltage	VOLTS			DO NOT OVERWRITE
Analog Value 808	Hood 14 Flow Voltage	VOLTS			DO NOT OVERWRITE
Analog Value 809	Hood 15 Flow Voltage	VOLTS			DO NOT OVERWRITE
Analog Value 810	Hood 16 Flow Voltage	VOLTS			DO NOT OVERWRITE
Analog Value 811	Hood 17 Flow Voltage	VOLTS			DO NOT OVERWRITE
Analog Value 812	Hood 18 Flow Voltage	VOLTS			DO NOT OVERWRITE
Analog Value 813	Hood 19 Flow Voltage	VOLTS			DO NOT OVERWRITE
Analog Value 814	Hood 20 Flow Voltage	VOLTS			DO NOT OVERWRITE
Analog Value 815	Hood 8 Venturi Minimum Flow	CFM	LPS	CMH	
Analog Value 816	Hood 8 Venturi Maximum Flow	CFM	LPS	CMH	
Analog Value 817	Hood 8 Venturi LOM ESC Time	SECONDS			
Analog Value 818	Hood 8 Linear Duct Area	FT <sup>2</sup>	M <sup>2</sup>	M <sup>2</sup>	
Analog Value 819	Hood 8 Linear Top Velocity	FT/MIN	M/S	M/S	
Analog Value 820	Hood 8 Linear Signal Minimum	VOLTS			
Analog Value 821	Hood 8 Linear Signal Maximum	VOLTS			
Analog Value 822	Hood 8 Pitot Sensor Zero	VOLTS			DO NOT OVERWRITE
Analog Value 823	Hood 8 Transducer Signal Minimum	VOLTS			
Analog Value 824	Hood 8 Transducer Signal Maximum	VOLTS			
Analog Value 825	Hood 8 Pitot Duct Area	FT <sup>2</sup>	M <sup>2</sup>	M <sup>2</sup>	
Analog Value 826	Hood 8 Transducer Sensor Maximum	in. W.C.	Pa	Pa	
Analog Value 827	Hood 8 Pitot Low Cal Flow	CFM	LPS	CMH	
Analog Value 828	Hood 8 Pitot High Cal Flow	CFM	LPS	CMH	
Analog Value 829	Hood 8 Pitot Low Cal Voltage	VOLTS			DO NOT OVERWRITE
Analog Value 830	Hood 8 Pitot High Cal Voltage	VOLTS			DO NOT OVERWRITE

BACnet Object Set	Object	Description	Units			Notes
			LRC00	-LPS	-CMH	
Analog Value 831	Hood 8 TP Min Flow	CFM	LPS	CMH		
Analog Value 832	Hood 8 TP Max Flow	CFM	LPS	CMH		
Analog Value 833	Hood 9 Venturi Minimum Flow	CFM	LPS	CMH		
Analog Value 834	Hood 9 Venturi Maximum Flow	CFM	LPS	CMH		
Analog Value 835	Hood 9 Venturi LOM ESC Time	SECONDS				
Analog Value 836	Hood 9 Linear Duct Area	FT <sup>2</sup>	M <sup>2</sup>	M <sup>2</sup>		
Analog Value 837	Hood 9 Linear Top Velocity	FT/MIN	M/S	M/S		
Analog Value 838	Hood 9 Linear Signal Minimum	VOLTS				
Analog Value 839	Hood 9 Linear Signal Maximum	VOLTS				
Analog Value 840	Hood 9 Pitot Sensor Zero	VOLTS			DO NOT OVERWRITE	
Analog Value 841	Hood 9 Transducer Signal Minimum	VOLTS				
Analog Value 842	Hood 9 Transducer Signal Maximum	VOLTS				
Analog Value 843	Hood 9 Pitot Duct Area	FT <sup>2</sup>	M <sup>2</sup>	M <sup>2</sup>		
Analog Value 844	Hood 9 Transducer Sensor Maximum	in. W.C.	Pa	Pa		
Analog Value 845	Hood 9 Pitot Low Cal Flow	CFM	LPS	CMH		
Analog Value 846	Hood 9 Pitot High Cal Flow	CFM	LPS	CMH		
Analog Value 847	Hood 9 Pitot Low Cal Voltage	VOLTS			DO NOT OVERWRITE	
Analog Value 848	Hood 9 Pitot High Cal Voltage	VOLTS			DO NOT OVERWRITE	
Analog Value 849	Hood 9 TP Min Flow	CFM	LPS	CMH		
Analog Value 850	Hood 9 TP Max Flow	CFM	LPS	CMH		
Analog Value 851	Hood 10 Venturi Minimum Flow	CFM	LPS	CMH		
Analog Value 852	Hood 10 Venturi Maximum Flow	CFM	LPS	CMH		
Analog Value 853	Hood 10 Venturi LOM ESC Time	SECONDS				
Analog Value 854	Hood 10 Linear Duct Area	FT <sup>2</sup>	M <sup>2</sup>	M <sup>2</sup>		
Analog Value 855	Hood 10 Linear Top Velocity	FT/MIN	M/S	M/S		
Analog Value 856	Hood 10 Linear Signal Minimum	VOLTS				
Analog Value 857	Hood 10 Linear Signal Maximum	VOLTS				
Analog Value 858	Hood 10 Pitot Sensor Zero	VOLTS			DO NOT OVERWRITE	
Analog Value 859	Hood 10 Transducer Signal Minimum	VOLTS				
Analog Value 860	Hood 10 Transducer Signal Maximum	VOLTS				
Analog Value 861	Hood 10 Pitot Duct Area	FT <sup>2</sup>	M <sup>2</sup>	M <sup>2</sup>		
Analog Value 862	Hood 10 Transducer Sensor Maximum	in. W.C.	Pa	Pa		
Analog Value 863	Hood 10 Pitot Low Cal Flow	CFM	LPS	CMH		
Analog Value 864	Hood 10 Pitot High Cal Flow	CFM	LPS	CMH		
Analog Value 865	Hood 10 Pitot Low Cal Voltage	VOLTS			DO NOT OVERWRITE	
Analog Value 866	Hood 10 Pitot High Cal Voltage	VOLTS			DO NOT OVERWRITE	
Analog Value 867	Hood 10 TP Min Flow	CFM	LPS	CMH		
Analog Value 868	Hood 10 TP Max Flow	CFM	LPS	CMH		
Analog Value 869	Hood 11 Venturi Minimum Flow	CFM	LPS	CMH		
Analog Value 870	Hood 11 Venturi Maximum Flow	CFM	LPS	CMH		
Analog Value 871	Hood 11 Venturi LOM ESC Time	SECONDS				
Analog Value 872	Hood 11 Linear Duct Area	FT <sup>2</sup>	M <sup>2</sup>	M <sup>2</sup>		
Analog Value 873	Hood 11 Linear Top Velocity	FT/MIN	M/S	M/S		
Analog Value 874	Hood 11 Linear Signal Minimum	VOLTS				
Analog Value 875	Hood 11 Linear Signal Maximum	VOLTS				
Analog Value 876	Hood 11 Pitot Sensor Zero	VOLTS			DO NOT OVERWRITE	

BACnet Object Set	Description	Units			Notes
		LRC00	-LPS	-CMH	
Analog Value 877	Hood 11 Transducer Signal Minimum	VOLTS			
Analog Value 878	Hood 11 Transducer Signal Maximum	VOLTS			
Analog Value 879	Hood 11 Pitot Duct Area	FT <sup>2</sup>	M <sup>2</sup>	M <sup>2</sup>	
Analog Value 880	Hood 11 Transducer Sensor Maximum	in. W.C.	Pa	Pa	
Analog Value 881	Hood 11 Pitot Low Cal Flow	CFM	LPS	CMH	
Analog Value 882	Hood 11 Pitot High Cal Flow	CFM	LPS	CMH	
Analog Value 883	Hood 11 Pitot Low Cal Voltage	VOLTS			DO NOT OVERWRITE
Analog Value 884	Hood 11 Pitot High Cal Voltage	VOLTS			DO NOT OVERWRITE
Analog Value 885	Hood 11 TP Min Flow	CFM	LPS	CMH	
Analog Value 886	Hood 11 TP Max Flow	CFM	LPS	CMH	
Analog Value 887	Hood 12 Venturi Minimum Flow	CFM	LPS	CMH	
Analog Value 888	Hood 12 Venturi Maximum Flow	CFM	LPS	CMH	
Analog Value 889	Hood 12 Venturi LOM ESC Time	SECONDS			
Analog Value 890	Hood 12 Linear Duct Area	FT <sup>2</sup>	M <sup>2</sup>	M <sup>2</sup>	
Analog Value 891	Hood 12 Linear Top Velocity	FT/MIN	M/S	M/S	
Analog Value 892	Hood 12 Linear Signal Minimum	VOLTS			
Analog Value 893	Hood 12 Linear Signal Maximum	VOLTS			
Analog Value 894	Hood 12 Pitot Sensor Zero	VOLTS			DO NOT OVERWRITE
Analog Value 895	Hood 12 Transducer Signal Minimum	VOLTS			
Analog Value 896	Hood 12 Transducer Signal Maximum	VOLTS			
Analog Value 897	Hood 12 Pitot Duct Area	FT <sup>2</sup>	M <sup>2</sup>	M <sup>2</sup>	
Analog Value 898	Hood 12 Transducer Sensor Maximum	in. W.C.	Pa	Pa	
Analog Value 899	Hood 12 Pitot Low Cal Flow	CFM	LPS	CMH	
Analog Value 900	Hood 12 Pitot High Cal Flow	CFM	LPS	CMH	
Analog Value 901	Hood 12 Pitot Low Cal Voltage	VOLTS			DO NOT OVERWRITE
Analog Value 902	Hood 12 Pitot High Cal Voltage	VOLTS			DO NOT OVERWRITE
Analog Value 903	Hood 12 TP Min Flow	CFM	LPS	CMH	
Analog Value 904	Hood 12 TP Max Flow	CFM	LPS	CMH	
Analog Value 905	Hood 13 Venturi Minimum Flow	CFM	LPS	CMH	
Analog Value 906	Hood 13 Venturi Maximum Flow	CFM	LPS	CMH	
Analog Value 907	Hood 13 Venturi LOM ESC Time	SECONDS			
Analog Value 908	Hood 13 Linear Duct Area	FT <sup>2</sup>	M <sup>2</sup>	M <sup>2</sup>	
Analog Value 909	Hood 13 Linear Top Velocity	FT/MIN	M/S	M/S	
Analog Value 910	Hood 13 Linear Signal Minimum	VOLTS			
Analog Value 911	Hood 13 Linear Signal Maximum	VOLTS			
Analog Value 912	Hood 13 Pitot Sensor Zero	VOLTS			DO NOT OVERWRITE
Analog Value 913	Hood 13 Transducer Signal Minimum	VOLTS			
Analog Value 914	Hood 13 Transducer Signal Maximum	VOLTS			
Analog Value 915	Hood 13 Pitot Duct Area	FT <sup>2</sup>	M <sup>2</sup>	M <sup>2</sup>	
Analog Value 916	Hood 13 Transducer Sensor Maximum	in. W.C.	Pa	Pa	
Analog Value 917	Hood 13 Pitot Low Cal Flow	CFM	LPS	CMH	
Analog Value 918	Hood 13 Pitot High Cal Flow	CFM	LPS	CMH	
Analog Value 919	Hood 13 Pitot Low Cal Voltage	VOLTS			DO NOT OVERWRITE
Analog Value 920	Hood 13 Pitot High Cal Voltage	VOLTS			DO NOT OVERWRITE
Analog Value 921	Hood 13 TP Min Flow	CFM	LPS	CMH	
Analog Value 922	Hood 13 TP Max Flow	CFM	LPS	CMH	

BACnet Object Set	Description	Units			Notes
		LRC00	-LPS	-CMH	
Analog Value 923	Hood 14 Venturi Minimum Flow	CFM	LPS	CMH	
Analog Value 924	Hood 14 Venturi Maximum Flow	CFM	LPS	CMH	
Analog Value 925	Hood 14 Venturi LOM ESC Time	SECONDS			
Analog Value 926	Hood 14 Linear Duct Area	FT <sup>2</sup>	M <sup>2</sup>	M <sup>2</sup>	
Analog Value 927	Hood 14 Linear Top Velocity	FT/MIN	M/S	M/S	
Analog Value 928	Hood 14 Linear Signal Minimum	VOLTS			
Analog Value 929	Hood 14 Linear Signal Maximum	VOLTS			
Analog Value 930	Hood 14 Pitot Sensor Zero	VOLTS			DO NOT OVERWRITE
Analog Value 931	Hood 14 Transducer Signal Minimum	VOLTS			
Analog Value 932	Hood 14 Transducer Signal Maximum	VOLTS			
Analog Value 933	Hood 14 Pitot Duct Area	FT <sup>2</sup>	M <sup>2</sup>	M <sup>2</sup>	
Analog Value 934	Hood 14 Transducer Sensor Maximum	in. W.C.	Pa	Pa	
Analog Value 935	Hood 14 Pitot Low Cal Flow	CFM	LPS	CMH	
Analog Value 936	Hood 14 Pitot High Cal Flow	CFM	LPS	CMH	
Analog Value 937	Hood 14 Pitot Low Cal Voltage	VOLTS			DO NOT OVERWRITE
Analog Value 938	Hood 14 Pitot High Cal Voltage	VOLTS			DO NOT OVERWRITE
Analog Value 939	Hood 14 TP Min Flow	CFM	LPS	CMH	
Analog Value 940	Hood 14 TP Max Flow	CFM	LPS	CMH	
Analog Value 941	Hood 15 Venturi Minimum Flow	CFM	LPS	CMH	
Analog Value 942	Hood 15 Venturi Maximum Flow	CFM	LPS	CMH	
Analog Value 943	Hood 15 Venturi LOM ESC Time	SECONDS			
Analog Value 944	Hood 15 Linear Duct Area	FT <sup>2</sup>	M <sup>2</sup>	M <sup>2</sup>	
Analog Value 945	Hood 15 Linear Top Velocity	FT/MIN	M/S	M/S	
Analog Value 946	Hood 15 Linear Signal Minimum	VOLTS			
Analog Value 947	Hood 15 Linear Signal Maximum	VOLTS			
Analog Value 948	Hood 15 Pitot Sensor Zero	VOLTS			DO NOT OVERWRITE
Analog Value 949	Hood 15 Transducer Signal Minimum	VOLTS			
Analog Value 950	Hood 15 Transducer Signal Maximum	VOLTS			
Analog Value 951	Hood 15 Pitot Duct Area	FT <sup>2</sup>	M <sup>2</sup>	M <sup>2</sup>	
Analog Value 952	Hood 15 Transducer Sensor Maximum	in. W.C.	Pa	Pa	
Analog Value 953	Hood 15 Pitot Low Cal Flow	CFM	LPS	CMH	
Analog Value 954	Hood 15 Pitot High Cal Flow	CFM	LPS	CMH	
Analog Value 955	Hood 15 Pitot Low Cal Voltage	VOLTS			DO NOT OVERWRITE
Analog Value 956	Hood 15 Pitot High Cal Voltage	VOLTS			DO NOT OVERWRITE
Analog Value 957	Hood 15 TP Min Flow	CFM	LPS	CMH	
Analog Value 958	Hood 15 TP Max Flow	CFM	LPS	CMH	
Analog Value 959	Hood 16 Venturi Minimum Flow	CFM	LPS	CMH	
Analog Value 960	Hood 16 Venturi Maximum Flow	CFM	LPS	CMH	
Analog Value 961	Hood 16 Venturi LOM ESC Time	SECONDS			
Analog Value 962	Hood 16 Linear Duct Area	FT <sup>2</sup>	M <sup>2</sup>	M <sup>2</sup>	
Analog Value 963	Hood 16 Linear Top Velocity	FT/MIN	M/S	M/S	
Analog Value 964	Hood 16 Linear Signal Minimum	VOLTS			
Analog Value 965	Hood 16 Linear Signal Maximum	VOLTS			
Analog Value 966	Hood 16 Pitot Sensor Zero	VOLTS			DO NOT OVERWRITE
Analog Value 967	Hood 16 Transducer Signal Minimum	VOLTS			
Analog Value 968	Hood 16 Transducer Signal Maximum	VOLTS			

BACnet Object Set	Description	Units			Notes
		LRC00	-LPS	-CMH	
Analog Value 969	Hood 16 Pitot Duct Area	FT <sup>2</sup>	M <sup>2</sup>	M <sup>2</sup>	
Analog Value 970	Hood 16 Transducer Sensor Maximum	in. W.C.	Pa	Pa	
Analog Value 971	Hood 16 Pitot Low Cal Flow	CFM	LPS	CMH	
Analog Value 972	Hood 16 Pitot High Cal Flow	CFM	LPS	CMH	
Analog Value 973	Hood 16 Pitot Low Cal Voltage	VOLTS			DO NOT OVERWRITE
Analog Value 974	Hood 16 Pitot High Cal Voltage	VOLTS			DO NOT OVERWRITE
Analog Value 975	Hood 16 TP Min Flow	CFM	LPS	CMH	
Analog Value 976	Hood 16 TP Max Flow	CFM	LPS	CMH	
Analog Value 977	Hood 17 Venturi Minimum Flow	CFM	LPS	CMH	
Analog Value 978	Hood 17 Venturi Maximum Flow	CFM	LPS	CMH	
Analog Value 979	Hood 17 Venturi LOM ESC Time	SECONDS			
Analog Value 980	Hood 17 Linear Duct Area	FT <sup>2</sup>	M <sup>2</sup>	M <sup>2</sup>	
Analog Value 981	Hood 17 Linear Top Velocity	FT/MIN	M/S	M/S	
Analog Value 982	Hood 17 Linear Signal Minimum	VOLTS			
Analog Value 983	Hood 17 Linear Signal Maximum	VOLTS			
Analog Value 984	Hood 17 Pitot Sensor Zero	VOLTS			DO NOT OVERWRITE
Analog Value 985	Hood 17 Transducer Signal Minimum	VOLTS			
Analog Value 986	Hood 17 Transducer Signal Maximum	VOLTS			
Analog Value 987	Hood 17 Pitot Duct Area	FT <sup>2</sup>	M <sup>2</sup>	M <sup>2</sup>	
Analog Value 988	Hood 17 Transducer Sensor Maximum	in. W.C.	Pa	Pa	
Analog Value 989	Hood 17 Pitot Low Cal Flow	CFM	LPS	CMH	
Analog Value 990	Hood 17 Pitot High Cal Flow	CFM	LPS	CMH	
Analog Value 991	Hood 17 Pitot Low Cal Voltage	VOLTS			DO NOT OVERWRITE
Analog Value 992	Hood 17 Pitot High Cal Voltage	VOLTS			DO NOT OVERWRITE
Analog Value 993	Hood 17 TP Min Flow	CFM	LPS	CMH	
Analog Value 994	Hood 17 TP Max Flow	CFM	LPS	CMH	
Analog Value 995	Hood 18 Venturi Minimum Flow	CFM	LPS	CMH	
Analog Value 996	Hood 18 Venturi Maximum Flow	CFM	LPS	CMH	
Analog Value 997	Hood 18 Venturi LOM ESC Time	SECONDS			
Analog Value 998	Hood 18 Linear Duct Area	FT <sup>2</sup>	M <sup>2</sup>	M <sup>2</sup>	
Analog Value 999	Hood 18 Linear Top Velocity	FT/MIN	M/S	M/S	
Analog Value 1000	Hood 18 Linear Signal Minimum	VOLTS			
Analog Value 1001	Hood 18 Linear Signal Maximum	VOLTS			
Analog Value 1002	Hood 18 Pitot Sensor Zero	VOLTS			DO NOT OVERWRITE
Analog Value 1003	Hood 18 Transducer Signal Minimum	VOLTS			
Analog Value 1004	Hood 18 Transducer Signal Maximum	VOLTS			
Analog Value 1005	Hood 18 Pitot Duct Area	FT <sup>2</sup>	M <sup>2</sup>	M <sup>2</sup>	
Analog Value 1006	Hood 18 Transducer Sensor Maximum	in. W.C.	Pa	Pa	
Analog Value 1007	Hood 18 Pitot Low Cal Flow	CFM	LPS	CMH	
Analog Value 1008	Hood 18 Pitot High Cal Flow	CFM	LPS	CMH	
Analog Value 1009	Hood 18 Pitot Low Cal Voltage	VOLTS			DO NOT OVERWRITE
Analog Value 1010	Hood 18 Pitot High Cal Voltage	VOLTS			DO NOT OVERWRITE
Analog Value 1011	Hood 18 TP Min Flow	CFM	LPS	CMH	
Analog Value 1012	Hood 18 TP Max Flow	CFM	LPS	CMH	
Analog Value 1013	Hood 19 Venturi Minimum Flow	CFM	LPS	CMH	
Analog Value 1014	Hood 19 Venturi Maximum Flow	CFM	LPS	CMH	



BACnet Object Set	Object	Description	Units			Notes
			LRC00	-LPS	-CMH	
Analog Value 1015	Hood 19 Venturi LOM ESC Time	SECONDS				
Analog Value 1016	Hood 19 Linear Duct Area	FT <sup>2</sup>	M <sup>2</sup>	M <sup>2</sup>		
Analog Value 1017	Hood 19 Linear Top Velocity	FT/MIN	M/S	M/S		
Analog Value 1018	Hood 19 Linear Signal Minimum	VOLTS				
Analog Value 1019	Hood 19 Linear Signal Maximum	VOLTS				
Analog Value 1020	Hood 19 Pitot Sensor Zero	VOLTS			DO NOT OVERWRITE	
Analog Value 1021	Hood 19 Transducer Signal Minimum	VOLTS				
Analog Value 1022	Hood 19 Transducer Signal Maximum	VOLTS				
Analog Value 1023	Hood 19 Pitot Duct Area	FT <sup>2</sup>	M <sup>2</sup>	M <sup>2</sup>		
Analog Value 1024	Hood 19 Transducer Sensor Maximum	in. W.C.	Pa	Pa		
Analog Value 1025	Hood 19 Pitot Low Cal Flow	CFM	LPS	CMH		
Analog Value 1026	Hood 19 Pitot High Cal Flow	CFM	LPS	CMH		
Analog Value 1027	Hood 19 Pitot Low Cal Voltage	VOLTS			DO NOT OVERWRITE	
Analog Value 1028	Hood 19 Pitot High Cal Voltage	VOLTS			DO NOT OVERWRITE	
Analog Value 1029	Hood 19 TP Min Flow	CFM	LPS	CMH		
Analog Value 1030	Hood 19 TP Max Flow	CFM	LPS	CMH		
Analog Value 1031	Hood 20 Venturi Minimum Flow	CFM	LPS	CMH		
Analog Value 1032	Hood 20 Venturi Maximum Flow	CFM	LPS	CMH		
Analog Value 1033	Hood 20 Venturi LOM ESC Time	SECONDS				
Analog Value 1034	Hood 20 Linear Duct Area	FT <sup>2</sup>	M <sup>2</sup>	M <sup>2</sup>		
Analog Value 1035	Hood 20 Linear Top Velocity	FT/MIN	M/S	M/S		
Analog Value 1036	Hood 20 Linear Signal Minimum	VOLTS				
Analog Value 1037	Hood 20 Linear Signal Maximum	VOLTS				
Analog Value 1038	Hood 20 Pitot Sensor Zero	VOLTS			DO NOT OVERWRITE	
Analog Value 1039	Hood 20 Transducer Signal Minimum	VOLTS				
Analog Value 1040	Hood 20 Transducer Signal Maximum	VOLTS				
Analog Value 1041	Hood 20 Pitot Duct Area	FT <sup>2</sup>	M <sup>2</sup>	M <sup>2</sup>		
Analog Value 1042	Hood 20 Transducer Sensor Maximum	in. W.C.	Pa	Pa		
Analog Value 1043	Hood 20 Pitot Low Cal Flow	CFM	LPS	CMH		
Analog Value 1044	Hood 20 Pitot High Cal Flow	CFM	LPS	CMH		
Analog Value 1045	Hood 20 Pitot Low Cal Voltage	VOLTS			DO NOT OVERWRITE	
Analog Value 1046	Hood 20 Pitot High Cal Voltage	VOLTS			DO NOT OVERWRITE	
Analog Value 1047	Hood 20 TP Min Flow	CFM	LPS	CMH		
Analog Value 1048	Hood 20 TP Max Flow	CFM	LPS	CMH		
Analog Value 1049	Hood 8 Pitot Uncal Low Cal Flow	CFM	LPS	CMH	DO NOT OVERWRITE	
Analog Value 1050	Hood 8 Pitot Uncal High Cal Flow	CFM	LPS	CMH	DO NOT OVERWRITE	
Analog Value 1051	Hood 9 Pitot Uncal Low Cal Flow	CFM	LPS	CMH	DO NOT OVERWRITE	
Analog Value 1052	Hood 9 Pitot Uncal High Cal Flow	CFM	LPS	CMH	DO NOT OVERWRITE	
Analog Value 1053	Hood 10 Pitot Uncal Low Cal Flow	CFM	LPS	CMH	DO NOT OVERWRITE	
Analog Value 1054	Hood 10 Pitot Uncal High Cal Flow	CFM	LPS	CMH	DO NOT OVERWRITE	
Analog Value 1055	Hood 11 Pitot Uncal Low Cal Flow	CFM	LPS	CMH	DO NOT OVERWRITE	
Analog Value 1056	Hood 11 Pitot Uncal High Cal Flow	CFM	LPS	CMH	DO NOT OVERWRITE	
Analog Value 1057	Hood 12 Pitot Uncal Low Cal Flow	CFM	LPS	CMH	DO NOT OVERWRITE	
Analog Value 1058	Hood 12 Pitot Uncal High Cal Flow	CFM	LPS	CMH	DO NOT OVERWRITE	
Analog Value 1059	Hood 13 Pitot Uncal Low Cal Flow	CFM	LPS	CMH	DO NOT OVERWRITE	
Analog Value 1060	Hood 13 Pitot Uncal High Cal Flow	CFM	LPS	CMH	DO NOT OVERWRITE	

BACnet Object Set	Description	Units			Notes
		LRC00	-LPS	-CMH	
Analog Value 1061	Hood 14 Pitot Uncal Low Cal Flow	CFM	LPS	CMH	DO NOT OVERWRITE
Analog Value 1062	Hood 14 Pitot Uncal High Cal Flow	CFM	LPS	CMH	DO NOT OVERWRITE
Analog Value 1063	Hood 15 Pitot Uncal Low Cal Flow	CFM	LPS	CMH	DO NOT OVERWRITE
Analog Value 1064	Hood 15 Pitot Uncal High Cal Flow	CFM	LPS	CMH	DO NOT OVERWRITE
Analog Value 1065	Hood 16 Pitot Uncal Low Cal Flow	CFM	LPS	CMH	DO NOT OVERWRITE
Analog Value 1066	Hood 16 Pitot Uncal High Cal Flow	CFM	LPS	CMH	DO NOT OVERWRITE
Analog Value 1067	Hood 17 Pitot Uncal Low Cal Flow	CFM	LPS	CMH	DO NOT OVERWRITE
Analog Value 1068	Hood 17 Pitot Uncal High Cal Flow	CFM	LPS	CMH	DO NOT OVERWRITE
Analog Value 1069	Hood 18 Pitot Uncal Low Cal Flow	CFM	LPS	CMH	DO NOT OVERWRITE
Analog Value 1070	Hood 18 Pitot Uncal High Cal Flow	CFM	LPS	CMH	DO NOT OVERWRITE
Analog Value 1071	Hood 19 Pitot Uncal Low Cal Flow	CFM	LPS	CMH	DO NOT OVERWRITE
Analog Value 1072	Hood 19 Pitot Uncal High Cal Flow	CFM	LPS	CMH	DO NOT OVERWRITE
Analog Value 1073	Hood 20 Pitot Uncal Low Cal Flow	CFM	LPS	CMH	DO NOT OVERWRITE
Analog Value 1074	Hood 20 Pitot Uncal High Cal Flow	CFM	LPS	CMH	DO NOT OVERWRITE
Analog Value 1075	Hood 8 Flow K factor				
Analog Value 1076	Hood 9 Flow K factor				
Analog Value 1077	Hood 10 Flow K factor				
Analog Value 1078	Hood 11 Flow K factor				
Analog Value 1079	Hood 12 Flow K factor				
Analog Value 1080	Hood 13 Flow K factor				
Analog Value 1081	Hood 14 Flow K factor				
Analog Value 1082	Hood 15 Flow K factor				
Analog Value 1083	Hood 16 Flow K factor				
Analog Value 1084	Hood 17 Flow K factor				
Analog Value 1085	Hood 18 Flow K factor				
Analog Value 1086	Hood 19 Flow K factor				
Analog Value 1087	Hood 20 Flow K factor				
Analog Value 1088	Supply 1 Flow Setpoint	CFM	LPS	CMH	DO NOT OVERWRITE
Analog Value 1089	Supply 2 Flow Setpoint	CFM	LPS	CMH	DO NOT OVERWRITE
Analog Value 1090	Supply 3 Flow Setpoint	CFM	LPS	CMH	DO NOT OVERWRITE
Analog Value 1091	Supply 4 Flow Setpoint	CFM	LPS	CMH	DO NOT OVERWRITE
Analog Value 1092	Exhaust 1 Flow Setpoint	CFM	LPS	CMH	DO NOT OVERWRITE
Analog Value 1093	Exhaust 2 Flow Setpoint	CFM	LPS	CMH	DO NOT OVERWRITE
Analog Value 1094	Supply 5 Flow Proportional Gain				
Analog Value 1095	Supply 5 Flow Integral Time	SECONDS			
Analog Value 1096	Supply 5 Flow Speed	%			
Analog Value 1097	Supply 5 Flow Sensitivity	%			
Analog Value 1098	Supply 6 Flow Proportional Gain				
Analog Value 1099	Supply 6 Flow Integral Time	SECONDS			
Analog Value 1100	Supply 6 Flow Speed	%			
Analog Value 1101	Supply 6 Flow Sensitivity	%			
Analog Value 1102	Supply 5 Pitot Uncal Low Cal Flow	CFM	LPS	CMH	DO NOT OVERWRITE
Analog Value 1103	Supply 5 Pitot Uncal High Cal Flow	CFM	LPS	CMH	DO NOT OVERWRITE
Analog Value 1104	Supply 5 Venturi Minimum Flow	CFM	LPS	CMH	DO NOT OVERWRITE
Analog Value 1105	Supply 5 Venturi Minimum Flow	CFM	LPS	CMH	DO NOT OVERWRITE
Analog Value 1106	Supply 5 Flow K Factor				

BACnet Object Set	Object	Description	Units			Notes
			LRC00	-LPS	-CMH	
Analog Value 1107		Supply 5 Venturi Setup Position	%			
Analog Value 1108		Supply 5 Venturi LOM Esc Time	SECONDS			
Analog Value 1109		Supply 5 Linear Duct Area	FT <sup>2</sup>	M <sup>2</sup>	M <sup>2</sup>	
Analog Value 1110		Supply 5 Linear Top Velocity	FT/MIN	M/S	M/S	
Analog Value 1111		Supply 5 Linear Signal Minimum	VOLTS			
Analog Value 1112		Supply 5 Linear Signal Maximum	VOLTS			
Analog Value 1113		Supply 5 Pitot Sensor Zero	VOLTS			
Analog Value 1114		Supply 5 Pitot Low Cal Pos	%			
Analog Value 1115		Supply 5 Transducer Signal Minimum	VOLTS			
Analog Value 1116		Supply 5 Pitot High Cal Pos	%			
Analog Value 1117		Supply 5 Transducer Signal Maximum	VOLTS			
Analog Value 1118		Supply 5 Pitot Low Cal Flow	CFM	LPS	CMH	DO NOT OVERWRITE
Analog Value 1119		Supply 5 Pitot Duct Area	FT <sup>2</sup>	M <sup>2</sup>	M <sup>2</sup>	
Analog Value 1120		Supply 5 Pitot High Cal Flow	CFM	LPS	CMH	DO NOT OVERWRITE
Analog Value 1121		Supply 5 Transducer Sensor Maximum	in. W.C.	Pa	Pa	
Analog Value 1122		Supply 6 Pitot Uncal Low Cal Flow	CFM	LPS	CMH	DO NOT OVERWRITE
Analog Value 1123		Supply 6 Pitot Uncal High Cal Flow	CFM	LPS	CMH	DO NOT OVERWRITE
Analog Value 1124		Supply 6 Venturi Minimum Flow	CFM	LPS	CMH	DO NOT OVERWRITE
Analog Value 1125		Supply 6 Venturi Maximum Flow	CFM	LPS	CMH	DO NOT OVERWRITE
Analog Value 1126		Supply 6 Flow K Factor				
Analog Value 1127		Supply 6 Venturi Setup Position	%			
Analog Value 1128		Supply 6 Venturi LOM Esc Time	SECONDS			
Analog Value 1129		Supply 6 Linear Duct Area	FT <sup>2</sup>	M <sup>2</sup>	M <sup>2</sup>	
Analog Value 1130		Supply 6 Linear Top Velocity				
Analog Value 1131		Supply 6 Linear Signal Minimum	VOLTS			
Analog Value 1132		Supply 6 Linear Signal Maximum	VOLTS			
Analog Value 1133		Supply 6 Pitot Sensor Zero	VOLTS			
Analog Value 1134		Supply 6 Pitot Low Cal Pos	%			
Analog Value 1135		Supply 6 Transducer Signal Minimum	VOLTS			
Analog Value 1136		Supply 6 Pitot High Cal Pos	%			
Analog Value 1137		Supply 6 Transducer Signal Maximum	VOLTS			
Analog Value 1138		Supply 6 Pitot Low Cal Flow	CFM	LPS	CMH	DO NOT OVERWRITE
Analog Value 1139		Supply 6 Pitot Duct Area	FT <sup>2</sup>	M <sup>2</sup>	M <sup>2</sup>	
Analog Value 1140		Supply 6 Pitot High Cal Flow	CFM	LPS	CMH	DO NOT OVERWRITE
Analog Value 1141		Supply 6 Transducer Sensor Maximum	in. W.C.	Pa	Pa	
Analog Value 1142		Supply 5 Room Temp Offset	°F	°C	°C	
Analog Value 1143		Supply 6 Room Temp Offset	°F	°C	°C	
Analog Value 1144		Supply 5 Room Temp Adj Signal Minimum	VOLTS			
Analog Value 1145		Supply 5 Room Temp Adj Signal Maximum	VOLTS			
Analog Value 1146		Supply 5 Room Temp Adj Sensor Minimum	°F	°C	°C	
Analog Value 1147		Supply 5 Room Temp Adj Sensor Maximum	°F	°C	°C	
Analog Value 1148		Supply 6 Room Temp Adj Signal Minimum	VOLTS			
Analog Value 1149		Supply 6 Room Temp Adj Signal Maximum	VOLTS			
Analog Value 1150		Supply 6 Room Temp Adj Sensor Minimum	°F	°C	°C	
Analog Value 1151		Supply 6 Room Temp Adj Sensor Maximum	°F	°C	°C	
Analog Value 1152		Supply 5 Reheat/Cooling Delay	SECONDS			

BACnet Object Set	Object	Description	Units			Notes
			LRC00	-LPS	-CMH	
Analog Value 1153		Supply 6 Reheat/Cooling Delay	SECONDS			
Analog Value 1154		Supply 5 Room Temp Signal Minimum	VOLTS			
Analog Value 1155		Supply 5 Room Temp Signal Maximum	VOLTS			
Analog Value 1156		Supply 5 Room Temp Sensor Minimum	°F	°C	°C	
Analog Value 1157		Supply 5 Room Temp Sensor Maximum	°F	°C	°C	
Analog Value 1158		Supply 6 Room Temp Signal Minimum	VOLTS			
Analog Value 1159		Supply 6 Room Temp Signal Maximum	VOLTS			
Analog Value 1160		Supply 6 Room Temp Sensor Minimum	°F	°C	°C	
Analog Value 1161		Supply 6 Room Temp Sensor Maximum	°F	°C	°C	
Analog Value 1162		Supply 5 Temp Throttling Range	°F	°C	°C	
Analog Value 1163		Supply 6 Temp Throttling Range	°F	°C	°C	
Analog Value 1164		Supply 5 Temp Integral Time	SECONDS			
Analog Value 1165		Supply 6 Temp Integral Time	SECONDS			
Analog Value 1166		Current Supply 5 Minimum Flow Setpoint	CFM	LPS	CMH	DO NOT OVERWRITE
Analog Value 1167		Current Supply 5 Minimum Flow	CFM	LPS	CMH	DO NOT OVERWRITE
Analog Value 1168		Current Supply 5 Cooling Flow	CFM	LPS	CMH	DO NOT OVERWRITE
Analog Value 1169		Current Supply 5 Heating Flow	CFM	LPS	CMH	DO NOT OVERWRITE
Analog Value 1170		Current Supply 5 Maximum Flow	CFM	LPS	CMH	DO NOT OVERWRITE
Analog Value 1171		Current Supply 6 Minimum Flow Setpoint	CFM	LPS	CMH	DO NOT OVERWRITE
Analog Value 1172		Current Supply 6 Minimum Flow	CFM	LPS	CMH	DO NOT OVERWRITE
Analog Value 1173		Current Supply 6 Cooling Flow	CFM	LPS	CMH	DO NOT OVERWRITE
Analog Value 1174		Current Supply 6 Heating Flow	CFM	LPS	CMH	DO NOT OVERWRITE
Analog Value 1175		Current Supply 6 Maximum Flow	CFM	LPS	CMH	DO NOT OVERWRITE
Analog Value 1176		Current Supply 5 Heat Setpoint	°F	°C	°C	DO NOT OVERWRITE
Analog Value 1177		Current Supply 5 Cool Setpoint	°F	°C	°C	DO NOT OVERWRITE
Analog Value 1178		Current Supply 6 Heat Setpoint	°F	°C	°C	DO NOT OVERWRITE
Analog Value 1179		Current Supply 6 Cool Setpoint	°F	°C	°C	DO NOT OVERWRITE
Analog Value 1180		Supply 5 Flow	CFM	LPS	CMH	DO NOT OVERWRITE
Analog Value 1181		Supply 6 Flow	CFM	LPS	CMH	DO NOT OVERWRITE
Analog Value 1182		Current Supply 5 Temperature Control Position	%			DO NOT OVERWRITE
Analog Value 1183		Current Supply 5 Flow Control Position	%			DO NOT OVERWRITE
Analog Value 1184		Current Supply 6 Temperature Control Position	%			DO NOT OVERWRITE
Analog Value 1185		Current Supply 6 Flow Control Position	%			DO NOT OVERWRITE
Analog Value 1186		Supply 5 Room Temp	°F	°C	°C	DO NOT OVERWRITE
Analog Value 1187		Supply 6 Room Temp	°F	°C	°C	DO NOT OVERWRITE
Analog Value 1188		Supply 5 Room Temp Adj	°F	°C	°C	DO NOT OVERWRITE
Analog Value 1189		Supply 6 Room Temp Adj	°F	°C	°C	DO NOT OVERWRITE
Analog Value 1190		Supply 5 Flow Voltage	VOLTS			DO NOT OVERWRITE
Analog Value 1191		Supply 6 Flow Voltage	VOLTS			DO NOT OVERWRITE
Analog Value 1192		Supply 5 Room Temp Voltage	VOLTS			DO NOT OVERWRITE
Analog Value 1193		Supply 6 Room Temp Voltage	VOLTS			DO NOT OVERWRITE
Analog Value 1194		Supply 5 Room Temp Adjustment Voltage	VOLTS			DO NOT OVERWRITE
Analog Value 1195		Supply 6 Room Temp Adjustment Voltage	VOLTS			DO NOT OVERWRITE
Analog Value 1196		Supply 5 Flow Setpoint	CFM	LPS	CMH	
Analog Value 1197		Supply 6 Flow Setpoint	CFM	LPS	CMH	

BACnet Object Set	Object	Description	Units			Notes
			LRC00	-LPS	-CMH	
Analog Value 1198	Supply 5 Minimum Flow	CFM	LPS	CMH		
Analog Value 1199	Supply 5 Cooling Flow	CFM	LPS	CMH		
Analog Value 1200	Supply 5 Heating Flow	CFM	LPS	CMH		
Analog Value 1201	Supply 5 Maximum Flow	CFM	LPS	CMH		
Analog Value 1202	Supply 5 Minimum Position	%				
Analog Value 1203	Supply 5 Maximum Position	%				
Analog Value 1204	Supply 5 Emergency Flow	CFM	LPS	CMH		
Analog Value 1205	Supply 5 Shutdown Flow	CFM	LPS	CMH		
Analog Value 1206	Supply 6 Minimum Flow	CFM	LPS	CMH		
Analog Value 1207	Supply 6 Cooling Flow	CFM	LPS	CMH		
Analog Value 1208	Supply 6 Heating Flow	CFM	LPS	CMH		
Analog Value 1209	Supply 6 Maximum Flow	CFM	LPS	CMH		
Analog Value 1210	Supply 6 Minimum Position	%				
Analog Value 1211	Supply 6 Maximum Position	%				
Analog Value 1212	Supply 6 Emergency Flow	CFM	LPS	CMH		
Analog Value 1213	Supply 6 Shutdown Flow	CFM	LPS	CMH		
Analog Value 1214	Supply 5 Heat Setpoint	°F	°C	°C		
Analog Value 1215	Supply 5 Cool Setpoint	°F	°C	°C		
Analog Value 1216	Supply 6 Heat Setpoint	°F	°C	°C		
Analog Value 1217	Supply 6 Cool Setpoint	°F	°C	°C		
Analog Value 1218	Supply 5 Low Flow Alarm	CFM	LPS	CMH		
Analog Value 1219	Supply 5 High Flow Alarm	CFM	LPS	CMH		
Analog Value 1220	Supply 6 Low Flow Alarm	CFM	LPS	CMH		
Analog Value 1221	Supply 6 High Flow Alarm	CFM	LPS	CMH		
Analog Value 1222	Supply 5 Low Temperature Alarm	°F	°C	°C		
Analog Value 1223	Supply 5 High Temperature Alarm	°F	°C	°C		
Analog Value 1224	Supply 6 Low Temperature Alarm	°F	°C	°C		
Analog Value 1225	Supply 6 High Temperature Alarm	°F	°C	°C		
Analog Value 1226	Supply 5 Shutdown Low Flow Alarm	CFM	LPS	CMH		
Analog Value 1227	Supply 5 Shutdown High Flow Alarm	CFM	LPS	CMH		
Analog Value 1228	Supply 6 Shutdown Low Flow Alarm	CFM	LPS	CMH		
Analog Value 1229	Supply 6 Shutdown High Flow Alarm	CFM	LPS	CMH		
Analog Value 1230	Supply 5 Flow Change	CFM	LPS	CMH		
Analog Value 1231	Supply 6 Flow Change	CFM	LPS	CMH		
Analog Value 1232	Supply 5 Flow Input Number				DO NOT OVERWRITE	
Analog Value 1233	Supply 5 Room Temp Input Number				DO NOT OVERWRITE	
Analog Value 1234	Supply 5 Room Temp Adj Input Number				DO NOT OVERWRITE	
Analog Value 1235	Supply 6 Flow Input Number				DO NOT OVERWRITE	
Analog Value 1236	Supply 6 Room Temp Input Number				DO NOT OVERWRITE	
Analog Value 1237	Supply 6 Room Temp Adj Input Number				DO NOT OVERWRITE	
Analog Value 1238	Current Supply 5 Low Flow Alarm	CFM	LPS	CMH	DO NOT OVERWRITE	
Analog Value 1239	Current Supply 5 High Flow Alarm	CFM	LPS	CMH	DO NOT OVERWRITE	
Analog Value 1240	Current Supply 6 Low Flow Alarm	CFM	LPS	CMH	DO NOT OVERWRITE	
Analog Value 1241	Current Supply 6 High Flow Alarm	CFM	LPS	CMH	DO NOT OVERWRITE	
Analog Value 1242	Current Supply 5 Low Temperature Alarm	°F	°C	°C	DO NOT OVERWRITE	
Analog Value 1243	Current Supply 5 High Temperature Alarm	°F	°C	°C	DO NOT OVERWRITE	

BACnet Object Set	Description	Units			Notes
		LRC00	-LPS	-CMH	
Analog Value 1244	Current Supply 6 Low Temperature Alarm	°F	°C	°C	DO NOT OVERWRITE
Analog Value 1245	Current Supply 6 High Temperature Alarm	°F	°C	°C	DO NOT OVERWRITE
Analog Value 1246	Supply 5 Pitot Low Cal Voltage	VOLTS			DO NOT OVERWRITE
Analog Value 1247	Supply 5 Pitot High Cal Voltage	VOLTS			DO NOT OVERWRITE
Analog Value 1248	Supply 6 Pitot Low Cal Voltage	VOLTS			DO NOT OVERWRITE
Analog Value 1249	Supply 6 Pitot High Cal Voltage	VOLTS			DO NOT OVERWRITE
Analog Value 1250	Supply 5 DAT Offset	°F	°C	°C	
Analog Value 1251	Supply 6 DAT Offset	°F	°C	°C	
Analog Value 1252	Supply 5 Unocc Minimum Flow	CFM	LPS	CMH	
Analog Value 1253	Supply 5 Unocc Cooling Flow	CFM	LPS	CMH	
Analog Value 1254	Supply 5 Unocc Heating Flow	CFM	LPS	CMH	
Analog Value 1255	Supply 5 Unocc Maximum Flow	CFM	LPS	CMH	
Analog Value 1256	Supply 6 Unocc Minimum Flow	CFM	LPS	CMH	
Analog Value 1257	Supply 6 Unocc Cooling Flow	CFM	LPS	CMH	
Analog Value 1258	Supply 6 Unocc Heating Flow	CFM	LPS	CMH	
Analog Value 1259	Supply 6 Unocc Maximum Flow	CFM	LPS	CMH	
Analog Value 1260	Supply 5 Unocc Heat Setpoint	°F	°C	°C	
Analog Value 1261	Supply 5 Unocc Cool Setpoint	°F	°C	°C	
Analog Value 1262	Supply 5 DAT Delta	°F	°C	°C	
Analog Value 1263	Supply 6 Unocc Heat Setpoint	°F	°C	°C	
Analog Value 1264	Supply 6 Unocc Cool Setpoint	°F	°C	°C	
Analog Value 1265	Supply 6 DAT Delta	°F	°C	°C	
Analog Value 1266	Supply 5 Unocc Low Flow Alarm	CFM	LPS	CMH	
Analog Value 1267	Supply 5 Unocc High Flow Alarm	CFM	LPS	CMH	
Analog Value 1268	Supply 6 Unocc Low Flow Alarm	CFM	LPS	CMH	
Analog Value 1269	Supply 6 Unocc High Flow Alarm	CFM	LPS	CMH	
Analog Value 1270	Supply 5 Unocc Low Temperature Alarm	°F	°C	°C	
Analog Value 1271	Supply 5 Unocc High Temperature Alarm	°F	°C	°C	
Analog Value 1272	Supply 6 Unocc Low Temperature Alarm	°F	°C	°C	
Analog Value 1273	Supply 6 Unocc High Temperature Alarm	°F	°C	°C	
Analog Value 1274	Supply 5 High DAT Alarm	°F	°C	°C	
Analog Value 1275	Supply 6 High DAT Alarm	°F	°C	°C	
Analog Value 1276	Supply 5 DAT Signal Minimum	VOLTS			
Analog Value 1277	Supply 5 DAT Signal Maximum	VOLTS			
Analog Value 1278	Supply 5 DAT Sensor Minimum	°F	°C	°C	
Analog Value 1279	Supply 5 DAT Sensor Maximum	°F	°C	°C	
Analog Value 1280	Supply 6 DAT Signal Minimum	VOLTS			
Analog Value 1281	Supply 6 DAT Signal Maximum	VOLTS			
Analog Value 1282	Supply 6 DAT Sensor Minimum	°F	°C	°C	
Analog Value 1283	Supply 6 DAT Sensor Maximum	°F	°C	°C	
Analog Value 1284	Supply 5 DAT Input Number				DO NOT OVERWRITE
Analog Value 1285	Supply 5 Occupancy Input Number				DO NOT OVERWRITE
Analog Value 1286	Supply 6 DAT Input Number				DO NOT OVERWRITE
Analog Value 1287	Supply 6 Occupancy Input Number				DO NOT OVERWRITE
Analog Value 1288	Supply 5 DAT	°F	°C	°C	DO NOT OVERWRITE
Analog Value 1289	Supply 6 DAT	°F	°C	°C	DO NOT OVERWRITE

BACnet Object Set	Description	Units			Notes
		LRC00	-LPS	-CMH	
Analog Value 1290	Supply 5 DAT Voltage	VOLTS			DO NOT OVERWRITE
Analog Value 1291	Supply 6 DAT Voltage	VOLTS			DO NOT OVERWRITE

Object	Description	Value	
Binary Value 1	Reset Variables	0: No 1: Yes	
Binary Value 2	Reset Control	0: No 1: Yes	
Binary Value 3	Supply 1 Flow Control Mode	0: Auto 1: Manual	
Binary Value 4	Supply 2 Flow Control Mode		
Binary Value 5	Supply 3 Flow Control Mode		
Binary Value 6	Supply 4 Flow Control Mode		
Binary Value 7	Supply 1 Temp Control Mode		
Binary Value 8	Supply 2 Temp Control Mode		
Binary Value 9	Supply 3 Temp Control Mode		
Binary Value 10	Supply 4 Temp Control Mode		
Binary Value 11	Exhaust 1 Flow Control Mode		
Binary Value 12	Exhaust 2 Flow Control Mode		
Binary Value 13	Not applicable		Not applicable
Binary Value 14	Not applicable		Not applicable
Binary Value 15	Supply 1 Balancer Mode	0: Off 1: On	
Binary Value 16	Supply 2 Balancer Mode		
Binary Value 17	Supply 3 Balancer Mode		
Binary Value 18	Supply 4 Balancer Mode		
Binary Value 19	Exhaust 1 Balancer Mode		
Binary Value 20	Exhaust 2 Balancer Mode		
Binary Value 21	Door Mode	0: Closed 1: Open	
Binary Value 22	Emergency Mode	0: Inactive 1: Active	
Binary Value 23	Shutdown Mode	0: Inactive 1: Active	
Binary Value 24	Supply 1 Occupancy Mode	0: Occupied 1: Unoccupied	
Binary Value 25	Supply 2 Occupancy Mode		
Binary Value 26	Supply 3 Occupancy Mode		
Binary Value 27	Supply 4 Occupancy Mode		
Binary Value 28	Supply 1 Venturi Visible	Not applicable	
Binary Value 29	Supply 1 Linear Visible	Not applicable	
Binary Value 30	Supply 1 Pitot Visible	Not applicable	
Binary Value 31	Supply 2 Venturi Visible	Not applicable	
Binary Value 32	Supply 2 Linear Visible	Not applicable	
Binary Value 33	Supply 2 Pitot Visible	Not applicable	
Binary Value 34	Supply 3 Venturi Visible	Not applicable	
Binary Value 35	Supply 3 Linear Visible	Not applicable	
Binary Value 36	Supply 3 Pitot Visible	Not applicable	
Binary Value 37	Supply 4 Venturi Visible	Not applicable	
Binary Value 38	Supply 4 Linear Visible	Not applicable	
Binary Value 39	Supply 4 Pitot Visible	Not applicable	

<b>Object</b>	<b>Description</b>	<b>Value</b>
Binary Value 40	Exhaust 1 Venturi Visible	Not applicable
Binary Value 41	Exhaust 1 Linear Visible	Not applicable
Binary Value 42	Exhaust 1 Pitot Visible	Not applicable
Binary Value 43	Exhaust 2 Venturi Visible	Not applicable
Binary Value 44	Exhaust 2 Linear Visible	Not applicable
Binary Value 45	Exhaust 2 Pitot Visible	Not applicable
Binary Value 46	Supply 1 DAT RTD Visible	Not applicable
Binary Value 47	Supply 1 DAT Voltage Visible	Not applicable
Binary Value 48	Supply 2 DAT RTD Visible	Not applicable
Binary Value 49	Supply 2 DAT Voltage Visible	Not applicable
Binary Value 50	Supply 3 DAT RTD Visible	Not applicable
Binary Value 51	Supply 3 DAT Voltage Visible	Not applicable
Binary Value 52	Supply 4 DAT RTD Visible	Not applicable
Binary Value 53	Supply 4 DAT Voltage Visible	Not applicable
Binary Value 54	Room Pressure TTW Visible	Not applicable
Binary Value 55	Room Pressure Transducer Visible	Not applicable
Binary Value 56	Hood 1 Venturi Visible	Not applicable
Binary Value 57	Hood 1 Linear Visible	Not applicable
Binary Value 58	Hood 1 Pitot Visible	Not applicable
Binary Value 59	Hood 1 Two Position Visible	Not applicable
Binary Value 60	Hood 2 Venturi Visible	Not applicable
Binary Value 61	Hood 2 Linear Visible	Not applicable
Binary Value 62	Hood 2 Pitot Visible	Not applicable
Binary Value 63	Hood 2 Two Position Visible	Not applicable
Binary Value 64	Hood 3 Venturi Visible	Not applicable
Binary Value 65	Hood 3 Linear Visible	Not applicable
Binary Value 66	Hood 3 Pitot Visible	Not applicable
Binary Value 67	Hood 3 Two Position Visible	Not applicable
Binary Value 68	Hood 4 Venturi Visible	Not applicable
Binary Value 69	Hood 4 Linear Visible	Not applicable
Binary Value 70	Hood 4 Pitot Visible	Not applicable
Binary Value 71	Hood 4 Two Position Visible	Not applicable
Binary Value 72	Hood 5 Venturi Visible	Not applicable
Binary Value 73	Hood 5 Linear Visible	Not applicable
Binary Value 74	Hood 5 Pitot Visible	Not applicable
Binary Value 75	Hood 5 Two Position Visible	Not applicable
Binary Value 76	Hood 6 Venturi Visible	Not applicable
Binary Value 77	Hood 6 Linear Visible	Not applicable
Binary Value 78	Hood 6 Pitot Visible	Not applicable
Binary Value 79	Hood 6 Two Position Visible	Not applicable
Binary Value 80	Hood 7 Venturi Visible	Not applicable
Binary Value 81	Hood 7 Linear Visible	Not applicable
Binary Value 82	Hood 7 Pitot Visible	Not applicable
Binary Value 83	Hood 7 Two Position Visible	Not applicable



Object	Description	Value
Binary Value 84	Door Switch Direction	0: Direct 1: Reverse
Binary Value 85	Emergency Switch Direction	
Binary Value 86	Shutdown Switch Direction	
Binary Value 87	Supply 1 Occupancy Direction	
Binary Value 88	Supply 2 Occupancy Direction	
Binary Value 89	Supply 3 Occupancy Direction	
Binary Value 90	Supply 4 Occupancy Direction	
Binary Value 91	Supply 1 Reheat Mode	Not applicable
Binary Value 92	Supply 2 Reheat Mode	Not applicable
Binary Value 93	Supply 3 Reheat Mode	Not applicable
Binary Value 94	Supply 1 PID Control Mode	Not applicable
Binary Value 95	Supply 2 PID Control Mode	Not applicable
Binary Value 96	Supply 3 PID Control Mode	Not applicable
Binary Value 97	Supply 4 PID Control Mode	Not applicable
Binary Value 98	Exhaust 1 PID Control Mode	Not applicable
Binary Value 99	Exhaust 2 PID Control Mode	Not applicable
Binary Value 100	Hood 8 Venturi Visible	Not applicable
Binary Value 101	Hood 8 Linear Visible	Not applicable
Binary Value 102	Hood 8 Pitot Visible	Not applicable
Binary Value 103	Hood 8 Two Position Visible	Not applicable
Binary Value 104	Hood 9 Venturi Visible	Not applicable
Binary Value 105	Hood 9 Linear Visible	Not applicable
Binary Value 106	Hood 9 Pitot Visible	Not applicable
Binary Value 107	Hood 9 Two Position Visible	Not applicable
Binary Value 108	Hood 10 Venturi Visible	Not applicable
Binary Value 109	Hood 10 Linear Visible	Not applicable
Binary Value 110	Hood 10 Pitot Visible	Not applicable
Binary Value 111	Hood 10 Two Position Visible	Not applicable
Binary Value 112	Hood 11 Venturi Visible	Not applicable
Binary Value 113	Hood 11 Linear Visible	Not applicable
Binary Value 114	Hood 11 Pitot Visible	Not applicable
Binary Value 115	Hood 11 Two Position Visible	Not applicable
Binary Value 116	Hood 12 Venturi Visible	Not applicable
Binary Value 117	Hood 12 Linear Visible	Not applicable
Binary Value 118	Hood 12 Pitot Visible	Not applicable
Binary Value 119	Hood 12 Two Position Visible	Not applicable
Binary Value 120	Hood 13 Venturi Visible	Not applicable
Binary Value 121	Hood 13 Linear Visible	Not applicable
Binary Value 122	Hood 13 Pitot Visible	Not applicable
Binary Value 123	Hood 13 Two Position Visible	Not applicable
Binary Value 124	Hood 14 Venturi Visible	Not applicable
Binary Value 125	Hood 14 Linear Visible	Not applicable
Binary Value 126	Hood 14 Pitot Visible	Not applicable
Binary Value 127	Hood 14 Two Position Visible	Not applicable

<b>Object</b>	<b>Description</b>	<b>Value</b>
Binary Value 128	Hood 15 Venturi Visible	Not applicable
Binary Value 129	Hood 15 Linear Visible	Not applicable
Binary Value 130	Hood 15 Pitot Visible	Not applicable
Binary Value 131	Hood 15 Two Position Visible	Not applicable
Binary Value 132	Hood 16 Venturi Visible	Not applicable
Binary Value 133	Hood 16 Linear Visible	Not applicable
Binary Value 134	Hood 16 Pitot Visible	Not applicable
Binary Value 135	Hood 16 Two Position Visible	Not applicable
Binary Value 136	Hood 17 Venturi Visible	Not applicable
Binary Value 137	Hood 17 Linear Visible	Not applicable
Binary Value 138	Hood 17 Pitot Visible	Not applicable
Binary Value 139	Hood 17 Two Position Visible	Not applicable
Binary Value 140	Hood 18 Venturi Visible	Not applicable
Binary Value 141	Hood 18 Linear Visible	Not applicable
Binary Value 142	Hood 18 Pitot Visible	Not applicable
Binary Value 143	Hood 18 Two Position Visible	Not applicable
Binary Value 144	Hood 19 Venturi Visible	Not applicable
Binary Value 145	Hood 19 Linear Visible	Not applicable
Binary Value 146	Hood 19 Pitot Visible	Not applicable
Binary Value 147	Hood 19 Two Position Visible	Not applicable
Binary Value 148	Hood 20 Venturi Visible	Not applicable
Binary Value 149	Hood 20 Linear Visible	Not applicable
Binary Value 150	Hood 20 Pitot Visible	Not applicable
Binary Value 151	Hood 20 Two Position Visible	Not applicable
Binary Value 152	Supply 4 Reheat Mode	Not applicable
Binary Value 153	Hood 1 TP Max Flow Signal	0: Open 1: Closed
Binary Value 154	Hood 2 TP Max Flow Signal	
Binary Value 155	Hood 3 TP Max Flow Signal	
Binary Value 156	Hood 4 TP Max Flow Signal	
Binary Value 157	Hood 5 TP Max Flow Signal	
Binary Value 158	Hood 6 TP Max Flow Signal	
Binary Value 159	Hood 7 TP Max Flow Signal	
Binary Value 160	Hood 8 TP Max Flow Signal	
Binary Value 161	Hood 9 TP Max Flow Signal	
Binary Value 162	Hood 10 TP Max Flow Signal	

Object	Description	Value
Binary Value 163	Hood 11 TP Max Flow Signal	0: Open 1: Closed
Binary Value 164	Hood 12 TP Max Flow Signal	
Binary Value 165	Hood 13 TP Max Flow Signal	
Binary Value 166	Hood 14 TP Max Flow Signal	
Binary Value 167	Hood 15 TP Max Flow Signal	
Binary Value 168	Hood 16 TP Max Flow Signal	
Binary Value 169	Hood 17 TP Max Flow Signal	
Binary Value 170	Hood 18 TP Max Flow Signal	
Binary Value 171	Hood 19 TP Max Flow Signal	
Binary Value 172	Hood 20 TP Max Flow Signal	
Binary Value 173	Supply 1 Flow Control Direction	0: Reverse 1: Direct
Binary Value 174	Supply 2 Flow Control Direction	
Binary Value 175	Supply 3 Flow Control Direction	
Binary Value 176	Supply 4 Flow Control Direction	
Binary Value 177	Exhaust 1 Flow Control Direction	
Binary Value 178	Exhaust 2 Flow Control Direction	
Binary Value 179	Supply 1 Temp Control Direction	
Binary Value 180	Supply 2 Temp Control Direction	
Binary Value 181	Supply 3 Temp Control Direction	Not applicable
Binary Value 182	Supply 4 Temp Control Direction	
Binary Value 183	Supply 1 Flow Control Active	
Binary Value 184	Supply 2 Flow Control Active	
Binary Value 185	Supply 3 Flow Control Active	
Binary Value 186	Supply 4 Flow Control Active	
Binary Value 187	Exhaust 1 Flow Control Active	
Binary Value 188	Exhaust 2 Flow Control Active	
Binary Value 189	Supply 1 Temp Control Active	
Binary Value 190	Supply 2 Temp Control Active	
Binary Value 191	Supply 3 Temp Control Active	
Binary Value 192	Supply 4 Temp Control Active	
Binary Value 193	Reset Output Selection	
Binary Value 194	Reconfigure Outputs	
Binary Value 195	Supply 1 Flow Input Active	
Binary Value 196	Supply 1 DAT Input Active	
Binary Value 197	Supply 1 Room Temp Input Active	
Binary Value 198	Supply 1 Temp Setp Input Active	
Binary Value 199	Supply 1 Occupancy Input Active	
Binary Value 200	Supply 2 Flow Input Active	
Binary Value 201	Supply 2 DAT Input Active	
Binary Value 202	Supply 2 Room Temp Input Active	
Binary Value 203	Supply 2 Temp Setp Input Active	
Binary Value 204	Supply 2 Occupancy Input Active	
Binary Value 205	Supply 3 Flow Input Active	
Binary Value 206	Supply 3 DAT Input Active	

<b>Object</b>	<b>Description</b>	<b>Value</b>
Binary Value 207	Supply 3 Room Temp Input Active	Not applicable
Binary Value 208	Supply 3 Temp Setp Input Active	Not applicable
Binary Value 209	Supply 3 Occupancy Input Active	Not applicable
Binary Value 210	Supply 4 Flow Input Active	Not applicable
Binary Value 211	Supply 4 DAT Input Active	Not applicable
Binary Value 212	Supply 4 Room Temp Input Active	Not applicable
Binary Value 213	Supply 4 Temp Setp Input Active	Not applicable
Binary Value 214	Supply 4 Occupancy Input Active	Not applicable
Binary Value 215	Exhaust 1 Flow Input Active	Not applicable
Binary Value 216	Exhaust 2 Flow Input Active	Not applicable
Binary Value 217	Hood 1 Flow Input Active	Not applicable
Binary Value 218	Hood 2 Flow Input Active	Not applicable
Binary Value 219	Hood 3 Flow Input Active	Not applicable
Binary Value 220	Hood 4 Flow Input Active	Not applicable
Binary Value 221	Hood 5 Flow Input Active	Not applicable
Binary Value 222	Hood 6 Flow Input Active	Not applicable
Binary Value 223	Hood 7 Flow Input Active	Not applicable
Binary Value 224	Room Pressure Input Active	Not applicable
Binary Value 225	Relative Humidity Input Active	Not applicable
Binary Value 226	Door Switch Input Active	Not applicable
Binary Value 227	Emergency Switch Input Active	Not applicable
Binary Value 228	Shutdown Switch Input Active	Not applicable
Binary Value 229	Hood 8 Flow Input Active	Not applicable
Binary Value 230	Hood 9 Flow Input Active	Not applicable
Binary Value 231	Hood 10 Flow Input Active	Not applicable
Binary Value 232	Hood 11 Flow Input Active	Not applicable
Binary Value 233	Hood 12 Flow Input Active	Not applicable
Binary Value 234	Hood 13 Flow Input Active	Not applicable
Binary Value 235	Hood 14 Flow Input Active	Not applicable
Binary Value 236	Hood 15 Flow Input Active	Not applicable
Binary Value 237	Hood 16 Flow Input Active	Not applicable
Binary Value 238	Hood 17 Flow Input Active	Not applicable
Binary Value 239	Hood 18 Flow Input Active	Not applicable
Binary Value 240	Hood 19 Flow Input Active	Not applicable
Binary Value 241	Hood 20 Flow Input Active	Not applicable
Binary Value 242	Supply 1 DAT Delta Active	Not applicable
Binary Value 243	Supply 2 DAT Delta Active	Not applicable
Binary Value 244	Supply 3 DAT Delta Active	Not applicable
Binary Value 245	Supply 4 DAT Delta Active	Not applicable
Binary Value 246	Exhaust Configuration	0: Unganged 1: Ganged

Object	Description	Value
Binary Value 247	Reset Supply 1 Flow Tuning	0: No 1: Yes
Binary Value 248	Reset Supply 2 Flow Tuning	
Binary Value 249	Reset Supply 3 Flow Tuning	
Binary Value 250	Reset Supply 4 Flow Tuning	
Binary Value 251	Reset Exhaust 1 Flow Tuning	
Binary Value 252	Reset Exhaust 2 Flow Tuning	
Binary Value 253	Supply 1 Room Temp RTD Visible	0: No 1: Yes
Binary Value 254	Supply 1 Room Temp Voltage Visible	
Binary Value 255	Supply 2 Room Temp RTD Visible	
Binary Value 256	Supply 2 Room Temp Voltage Visible	
Binary Value 257	Supply 3 Room Temp RTD Visible	
Binary Value 258	Supply 3 Room Temp Voltage Visible	
Binary Value 259	Supply 4 Room Temp RTD Visible	
Binary Value 260	Supply 4 Room Temp Voltage Visible	
Binary Value 261	Reset Supply 5 Flow Tuning	
Binary Value 262	Reset Supply 6 Flow Tuning	
Binary Value 263	Supply 5 Flow Control Mode	0: Auto 1: Manual
Binary Value 264	Supply 6 Flow Control Mode	0: Auto 1: Manual
Binary Value 265	Supply 5 Temp Control Mode	0: Auto 1: Manual
Binary Value 266	Supply 6 Temp Control Mode	0: Auto 1: Manual
Binary Value 267	Supply 5 Balancer Mode	0: Off 1: On
Binary Value 268	Supply 6 Balancer Mode	0: Off 1: On
Binary Value 269	Supply 5 Flow Control Direction	0: Reverse 1: Direct
Binary Value 270	Supply 6 Flow Control Direction	0: Reverse 1: Direct
Binary Value 271	Supply 5 Temp Control Direction	0: Reverse 1: Direct
Binary Value 272	Supply 6 Temp Control Direction	0: Reverse 1: Direct
Binary Value 273	Supply 5 Venturi Visible	Not applicable
Binary Value 274	Supply 5 Linear Visible	Not applicable
Binary Value 275	Supply 5 Pitot Visible	Not applicable
Binary Value 276	Supply 6 Venturi Visible	Not applicable
Binary Value 277	Supply 6 Linear Visible	Not applicable
Binary Value 278	Supply 6 Pitot Visible	Not applicable
Binary Value 279	Supply 5 Room Temp Voltage Visible	Not applicable
Binary Value 280	Supply 6 Room Temp Voltage Visible	Not applicable
Binary Value 281	Supply 5 Flow Control Active	Not applicable
Binary Value 282	Supply 6 Flow Control Active	Not applicable
Binary Value 283	Supply 5 Temp Control Active	Not applicable
Binary Value 284	Supply 6 Temp Control Active	Not applicable
Binary Value 285	Supply 5 Flow Input Active	Not applicable
Binary Value 286	Supply 5 Room Temp Input Active	Not applicable
Binary Value 287	Supply 5 Room Temp Adj Input Active	Not applicable
Binary Value 288	Supply 6 Flow Input Active	Not applicable
Binary Value 289	Supply 6 Room Temp Input Active	Not applicable
Binary Value 290	Supply 6 Room Temp Adj Input Active	Not applicable

<b>Object</b>	<b>Description</b>	<b>Value</b>
Binary Value 291	Supply 5 Room Temp RTD Visible	Not applicable
Binary Value 292	Supply 6 Room Temp RTD Visible	Not applicable
Binary Value 293	Supply 5 Reheat Mode	Not applicable
Binary Value 294	Supply 6 Reheat Mode	Not applicable
Binary Value 295	Supply 5 PID Control Mode	Not applicable
Binary Value 296	Supply 6 PID Control Mode	Not applicable
Binary Value 297	Supply 5 Occupancy Mode	0: Occupied 1: Unoccupied
Binary Value 298	Supply 6 Occupancy Mode	0: Occupied 1: Unoccupied
Binary Value 299	Supply 5 Occupancy Direction	0: Reverse 1: Direct
Binary Value 300	Supply 6 Occupancy Direction	0: Reverse 1: Direct
Binary Value 301	Supply 5 DAT Voltage Visible	Not applicable
Binary Value 302	Supply 6 DAT Voltage Visible	Not applicable
Binary Value 303	Supply 5 DAT Input Active	Not applicable
Binary Value 304	Supply 5 Occupancy Input Active	Not applicable
Binary Value 305	Supply 6 DAT Input Active	Not applicable
Binary Value 306	Supply 6 Occupancy Input Active	Not applicable
Binary Value 307	Supply 5 DAT Delta Active	Not applicable
Binary Value 308	Supply 6 DAT Delta Active	Not applicable
Binary Value 309	Supply 5 DAT RTD Visible	Not applicable
Binary Value 310	Supply 6 DAT RTD Visible	Not applicable

*(continued on next page)*

Object	Description	Value	Notes
Multi State Value 1	Input 1 Input Type	1: Unconfigured	
Multi State Value 2	Input 2 Input Type	2: Supply 1 Flow	
Multi State Value 3	Input 3 Input Type	3: Supply 1 DAT	
Multi State Value 4	Input 4 Input Type	4: Supply 1 Room Temp	
Multi State Value 5	Input 5 Input Type	5: Supply 1 Temp Adjustment	
Multi State Value 6	Input 6 Input Type	6: Supply 1 Occupancy	
Multi State Value 7	Input 7 Input Type	7: Supply 2 Flow	
Multi State Value 8	Input 8 Input Type	8: Supply 2 DAT	
Multi State Value 9	Input 9 Input Type	9: Supply 2 Room Temp	
Multi State Value 10	Input 10 Input Type	10: Supply 2 Temp Adjustment	
Multi State Value 11	Input 11 Input Type	11: Supply 2 Occupancy	
Multi State Value 12	Input 12 Input Type	12: Supply 3 Flow	
Multi State Value 13	Input 13 Input Type	13: Supply 3 DAT	
Multi State Value 14	Input 14 Input Type	14: Supply 3 Room Temp	
Multi State Value 15	Input 15 Input Type	15: Supply 3 Temp Adjustment	
Multi State Value 16	Input 16 Input Type	16: Supply 3 Occupancy	
Multi State Value 17	Input 17 Input Type	17: Supply 4 Flow	
Multi State Value 18	Input 18 Input Type	18: Supply 4 DAT	
Multi State Value 19	Input 19 Input Type	19: Supply 4 Room Temp	
Multi State Value 20	Input 20 Input Type	20: Supply 4 Temp Adjustment	
Multi State Value 21	Input 21 Input Type	21: Supply 4 Occupancy	
Multi State Value 22	Input 22 Input Type	22: Exhaust 1 Flow	
Multi State Value 23	Input 23 Input Type	23: Exhaust 2 Flow	
Multi State Value 24	Input 24 Input Type	24: Hood 1 Flow	
Multi State Value 25	Input 25 Input Type	25: Hood 2 Flow	
Multi State Value 26	Input 26 Input Type	26: Hood 3 Flow	
Multi State Value 27	Input 27 Input Type	27: Hood 4 Flow	
Multi State Value 28	Input 28 Input Type	28: Hood 5 Flow	
Multi State Value 29	Input 29 Input Type	29: Hood 6 Flow	
Multi State Value 30	Input 30 Input Type	30: Hood 7 Flow	
Multi State Value 31	Input 31 Input Type	31: Room Pressure	
		32: Relative Humidity	
		33: Door Switch	
		34: Emergency Switch	
		35: Shutdown Switch	
		36: Hood 8 Flow	
		37: Hood 9 Flow	
		38: Hood 10 Flow	
		39: Hood 11 Flow	
		40: Hood 12 Flow	
		41: Hood 13 Flow	
		42: Hood 14 Flow	
		43: Hood 15 Flow	
		44: Hood 16 Flow	
		45: Hood 17 Flow	
		46: Hood 18 Flow	
		47: Hood 19 Flow	
		48: Hood 20 Flow	
Multi State Value 32	Input 32 Input Type		

Object	Description	Value	Notes
Multi State Value 33	Output 1 Output Type	1: Unconfigured 2: Supply 1 Temp 3: Supply 1 Flow 4: Supply 2 Temp 5: Supply 2 Flow 6: Supply 3 Temp 7: Supply 3 Flow 8: Supply 4 Temp 9: Supply 4 Flow 10: Exhaust 1 Flow 11: Exhaust 2 Flow	
Multi State Value 34	Output 2 Output Type		
Multi State Value 35	Output 3 Output Type		
Multi State Value 36	Output 4 Output Type		
Multi State Value 37	Output 5 Output Type		
Multi State Value 38	Output 6 Output Type		
Multi State Value 39	Output 7 Output Type		
Multi State Value 40	Output 8 Output Type		
Multi State Value 41	Output 9 Output Type		
Multi State Value 42	Output 10 Output Type		
Multi State Value 43	Output 11 Output Type		
Multi State Value 44	Output 12 Output Type		
Multi State Value 45	Supply 1 Flow Type	1: Unconfigured 2: Venturi 3: Linear 4: Pitot	
Multi State Value 46	Supply 2 Flow Type		
Multi State Value 47	Supply 3 Flow Type		
Multi State Value 48	Supply 4 Flow Type		
Multi State Value 49	Exhaust 1 Flow Type		
Multi State Value 50	Exhaust 2 Flow Type		
Multi State Value 51	Hood 1 Flow Type	1: Unconfigured 2: Venturi 3: Linear 4: Pitot 5: Two Position	
Multi State Value 52	Hood 2 Flow Type		
Multi State Value 53	Hood 3 Flow Type		
Multi State Value 54	Hood 4 Flow Type		
Multi State Value 55	Hood 5 Flow Type		
Multi State Value 56	Hood 6 Flow Type		
Multi State Value 57	Hood 7 Flow Type		
Multi State Value 58	Supply 1 DAT Type	1: Unconfigured 2: 0 to 10V 3: RTD	
Multi State Value 59	Supply 2 DAT Type		
Multi State Value 60	Supply 3 DAT Type		
Multi State Value 61	Supply 4 DAT Type		
Multi State Value 62	Room Pressure Type	1: Unconfigured 2: TTW Sensor 3: Pressure Transducer	
Multi State Value 63	Supply 1 Pitot Cal mode	1: Save 2: Low Cal Mode 3: High Cal Mode 4: Sensor Zero	
Multi State Value 64	Supply 2 Pitot Cal mode		
Multi State Value 65	Supply 3 Pitot Cal mode		
Multi State Value 66	Supply 4 Pitot Cal mode		
Multi State Value 67	Exhaust 1 Pitot Cal mode		
Multi State Value 68	Exhaust 2 Pitot Cal mode		
Multi State Value 69	Hood 1 Pitot Cal mode		
Multi State Value 70	Hood 2 Pitot Cal mode		
Multi State Value 71	Hood 3 Pitot Cal mode		
Multi State Value 72	Hood 4 Pitot Cal mode		
Multi State Value 73	Hood 5 Pitot Cal mode		
Multi State Value 74	Hood 6 Pitot Cal mode		
Multi State Value 75	Hood 7 Pitot Cal mode		



Object	Description	Value	Notes
Multi State Value 76	Current Supply 1 Flow Alarm Status	1: Normal 2: Low Alarm 3: High Alarm	DO NOT OVERWRITE
Multi State Value 77	Current Supply 2 Flow Alarm Status		DO NOT OVERWRITE
Multi State Value 78	Current Supply 3 Flow Alarm Status		DO NOT OVERWRITE
Multi State Value 79	Current Supply 4 Flow Alarm Status		DO NOT OVERWRITE
Multi State Value 80	Current Exhaust 1 Flow Alarm Status		DO NOT OVERWRITE
Multi State Value 81	Current Exhaust 2 Flow Alarm Status		DO NOT OVERWRITE
Multi State Value 82	Current Supply 1 Temp Alarm Status		DO NOT OVERWRITE
Multi State Value 83	Current Supply 2 Temp Alarm Status		DO NOT OVERWRITE
Multi State Value 84	Current Supply 3 Temp Alarm Status		DO NOT OVERWRITE
Multi State Value 85	Current Supply 4 Temp Alarm Status		DO NOT OVERWRITE
Multi State Value 86	Current Room Pressure Alarm Status		DO NOT OVERWRITE
Multi State Value 87	Current Supply 1 DAT Alarm Status		DO NOT OVERWRITE
Multi State Value 88	Current Supply 2 DAT Alarm Status		DO NOT OVERWRITE
Multi State Value 89	Current Supply 3 DAT Alarm Status		DO NOT OVERWRITE
Multi State Value 90	Current Supply 4 DAT Alarm Status		DO NOT OVERWRITE
Multi State Value 91	Current Controller Flow Mode	1: Standard 2: Emergency 3: Shutdown 4: Balancer	DO NOT OVERWRITE
Multi State Value 92	Current Controller Pressure Mode	1: Normal 2: Door Open	DO NOT OVERWRITE
Multi State Value 93	Current Supply 1 No Flow Alarm Status	1: Normal 2: No Flow Alarm	DO NOT OVERWRITE
Multi State Value 94	Current Supply 2 No Flow Alarm Status		DO NOT OVERWRITE
Multi State Value 95	Current Supply 3 No Flow Alarm Status		DO NOT OVERWRITE
Multi State Value 96	Current Supply 4 No Flow Alarm Status		DO NOT OVERWRITE
Multi State Value 97	Current Supply 1 Feedback Alarm Status	1: Normal 2: Feedback Alarm	DO NOT OVERWRITE
Multi State Value 98	Current Supply 2 Feedback Alarm Status		DO NOT OVERWRITE
Multi State Value 99	Current Supply 3 Feedback Alarm Status		DO NOT OVERWRITE
Multi State Value 100	Current Supply 4 Feedback Alarm Status		DO NOT OVERWRITE
Multi State Value 101	Current Exhaust 1 No Flow Alarm Status	1: Normal 2: No Flow Alarm	DO NOT OVERWRITE
Multi State Value 102	Current Exhaust 2 No Flow Alarm Status		DO NOT OVERWRITE
Multi State Value 103	Current Exhaust 1 Feedback Alarm Status	1: Normal 2: Feedback Alarm	DO NOT OVERWRITE
Multi State Value 104	Current Exhaust 2 Feedback Alarm Status		DO NOT OVERWRITE
Multi State Value 105	Current Hood 1 No Flow Alarm Status	1: Normal 2: No Flow Alarm	DO NOT OVERWRITE
Multi State Value 106	Current Hood 2 No Flow Alarm Status		DO NOT OVERWRITE
Multi State Value 107	Current Hood 3 No Flow Alarm Status		DO NOT OVERWRITE
Multi State Value 108	Current Hood 4 No Flow Alarm Status		DO NOT OVERWRITE
Multi State Value 109	Current Hood 5 No Flow Alarm Status		DO NOT OVERWRITE
Multi State Value 110	Current Hood 6 No Flow Alarm Status		DO NOT OVERWRITE
Multi State Value 111	Current Hood 7 No Flow Alarm Status		DO NOT OVERWRITE
Multi State Value 112	Current Hood 1 Feedback Alarm Status		DO NOT OVERWRITE
Multi State Value 113	Current Hood 2 Feedback Alarm Status	1: Normal 2: Feedback Alarm	DO NOT OVERWRITE
Multi State Value 114	Current Hood 3 Feedback Alarm Status		DO NOT OVERWRITE
Multi State Value 115	Current Hood 4 Feedback Alarm Status		DO NOT OVERWRITE
Multi State Value 116	Current Hood 5 Feedback Alarm Status		DO NOT OVERWRITE
Multi State Value 117	Current Hood 6 Feedback Alarm Status		DO NOT OVERWRITE
Multi State Value 118	Current Hood 7 Feedback Alarm Status		DO NOT OVERWRITE

Object	Description	Value	Notes
Multi State Value 119	Room Pressure Cal Mode	1: Save 2: Sensor Zero	
Multi State Value 120	Current Offset Alarm Status	1: Normal 2: Minimum Offset Alarm 3: Maximum Offset Alarm	DO NOT OVERWRITE
Multi State Value 121	Hood 8 Flow Type	1: Normal 2: Feedback Alarm	
Multi State Value 122	Hood 9 Flow Type		
Multi State Value 123	Hood 10 Flow Type		
Multi State Value 124	Hood 11 Flow Type		
Multi State Value 125	Hood 12 Flow Type		
Multi State Value 126	Hood 13 Flow Type		
Multi State Value 127	Hood 14 Flow Type		
Multi State Value 128	Hood 15 Flow Type		
Multi State Value 129	Hood 16 Flow Type		
Multi State Value 130	Hood 17 Flow Type		
Multi State Value 131	Hood 18 Flow Type		
Multi State Value 132	Hood 19 Flow Type		
Multi State Value 133	Hood 20 Flow Type		
Multi State Value 134	Hood 8 Pitot Cal mode		1: Save 2: Low Cal Mode 3: High Cal Mode 4: Sensor Zero
Multi State Value 135	Hood 9 Pitot Cal mode		
Multi State Value 136	Hood 10 Pitot Cal mode		
Multi State Value 137	Hood 11 Pitot Cal mode		
Multi State Value 138	Hood 12 Pitot Cal mode		
Multi State Value 139	Hood 13 Pitot Cal mode		
Multi State Value 140	Hood 14 Pitot Cal mode		
Multi State Value 141	Hood 15 Pitot Cal mode		
Multi State Value 142	Hood 16 Pitot Cal mode		
Multi State Value 143	Hood 17 Pitot Cal mode		
Multi State Value 144	Hood 18 Pitot Cal mode		
Multi State Value 145	Hood 19 Pitot Cal mode		
Multi State Value 146	Hood 20 Pitot Cal mode		
Multi State Value 147	Current Hood 8 No Flow Alarm Status	1: Normal 2: No Flow Alarm	DO NOT OVERWRITE
Multi State Value 148	Current Hood 9 No Flow Alarm Status		DO NOT OVERWRITE
Multi State Value 149	Current Hood 10 No Flow Alarm Status		DO NOT OVERWRITE
Multi State Value 150	Current Hood 11 No Flow Alarm Status		DO NOT OVERWRITE
Multi State Value 151	Current Hood 12 No Flow Alarm Status		DO NOT OVERWRITE
Multi State Value 152	Current Hood 13 No Flow Alarm Status		DO NOT OVERWRITE
Multi State Value 153	Current Hood 14 No Flow Alarm Status		DO NOT OVERWRITE
Multi State Value 154	Current Hood 15 No Flow Alarm Status		DO NOT OVERWRITE
Multi State Value 155	Current Hood 16 No Flow Alarm Status		DO NOT OVERWRITE
Multi State Value 156	Current Hood 17 No Flow Alarm Status		DO NOT OVERWRITE
Multi State Value 157	Current Hood 18 No Flow Alarm Status		DO NOT OVERWRITE
Multi State Value 158	Current Hood 19 No Flow Alarm Status		DO NOT OVERWRITE
Multi State Value 159	Current Hood 20 No Flow Alarm Status	DO NOT OVERWRITE	

Object	Description	Value	Notes
Multi State Value 160	Current Hood 8 Feedback Alarm Status	1: Normal 2: Feedback Alarm	DO NOT OVERWRITE
Multi State Value 161	Current Hood 9 Feedback Alarm Status		DO NOT OVERWRITE
Multi State Value 162	Current Hood 10 Feedback Alarm Status		DO NOT OVERWRITE
Multi State Value 163	Current Hood 11 Feedback Alarm Status		DO NOT OVERWRITE
Multi State Value 164	Current Hood 12 Feedback Alarm Status		DO NOT OVERWRITE
Multi State Value 165	Current Hood 13 Feedback Alarm Status		DO NOT OVERWRITE
Multi State Value 166	Current Hood 14 Feedback Alarm Status		DO NOT OVERWRITE
Multi State Value 167	Current Hood 15 Feedback Alarm Status		DO NOT OVERWRITE
Multi State Value 168	Current Hood 16 Feedback Alarm Status		DO NOT OVERWRITE
Multi State Value 169	Current Hood 17 Feedback Alarm Status		DO NOT OVERWRITE
Multi State Value 170	Current Hood 18 Feedback Alarm Status		DO NOT OVERWRITE
Multi State Value 171	Current Hood 19 Feedback Alarm Status		DO NOT OVERWRITE
Multi State Value 172	Current Hood 20 Feedback Alarm Status		DO NOT OVERWRITE
Multi State Value 173	Supply 1 Room Temp Type		1: Unconfigured 2: 0 to 10V 3: RTD
Multi State Value 174	Supply 2 Room Temp Type		
Multi State Value 175	Supply 3 Room Temp Type		
Multi State Value 176	Supply 4 Room Temp Type		
Multi State Value 177	Supply 5 Flow Type	1: Unconfigured 2: Venturi 3: Linear 4: Pitot	
Multi State Value 178	Supply 6 Flow Type		
Multi State Value 179	Supply 5 Room Temp Type	1: Unconfigured 2: 0 to 10V 3: RTD	
Multi State Value 180	Supply 6 Room Temp Type		
Multi State Value 181	Supply 5 Pitot Cal mode	1: Save 2: Low Cal Mode 3: High Cal Mode 4: Sensor Zero	
Multi State Value 182	Supply 6 Pitot Cal mode		
Multi State Value 183	Current Supply 5 Temp Alarm Status	1: Normal 2: Low Alarm 3: High Alarm	DO NOT OVERWRITE
Multi State Value 184	Current Supply 6 Temp Alarm Status		DO NOT OVERWRITE
Multi State Value 185	Current Supply 5 Flow Alarm Status		DO NOT OVERWRITE
Multi State Value 186	Current Supply 6 Flow Alarm Status		DO NOT OVERWRITE
Multi State Value 187	Current Supply 5 No Flow Alarm Status		DO NOT OVERWRITE
Multi State Value 188	Current Supply 6 No Flow Alarm Status		DO NOT OVERWRITE
Multi State Value 189	Current Supply 5 Feedback Alarm Status		DO NOT OVERWRITE
Multi State Value 190	Current Supply 6 Feedback Alarm Status		DO NOT OVERWRITE
Multi State Value 191	Supply 5 DAT Type	1: Unconfigured 2: 0 to 10V 3: RTD	
Multi State Value 192	Supply 6 DAT Type		
Multi State Value 193	Current Supply 5 DAT Alarm Status	1: Normal 2: Low Alarm 3: High Alarm	DO NOT OVERWRITE
Multi State Value 194	Current Supply 6 DAT Alarm Status		DO NOT OVERWRITE





UNDERSTANDING, ACCELERATED

**TSI Incorporated**—Visit our website [www.tsi.com](http://www.tsi.com) for more information.

<b>USA</b>	<b>Tel:</b> +1 800 680 1220	<b>India</b>	<b>Tel:</b> +91 80 67877200
<b>UK</b>	<b>Tel:</b> +44 149 4 459200	<b>China</b>	<b>Tel:</b> +86 10 8219 7688
<b>France</b>	<b>Tel:</b> +33 1 41 19 21 99	<b>Singapore</b>	<b>Tel:</b> +65 6595 6388
<b>Germany</b>	<b>Tel:</b> +49 241 523030		

P/N 6013156 Rev. E

©2021 TSI Incorporated

Printed in U.S.A.

