

CHEMICAL GAUGE GUARDS

WITH UNBREAKABLE STAINLESS STEEL INSTRUMENT CONNECTION



- Stainless steel hex insert eliminates breakage due to overtightening.
- No exposed top metal fasteners
- Highest pressure rating.
- Offers an inexpensive initial investment.
- Reduces instrument failures.
- Reduces system down time.
- Eliminates the expense and extended delivery of special alloy instruments.
- Offers a choice of select plastic materials to assure maximum chemical and temperature compatibility.
- ½" NPT pipe connection x ¼" stainless steel instrument connection or ½" all-plastic connection.
- Metric spigots and other connections available.
- Also offered with all-plastic housing (no stainless instrument connections).

APPLICATIONS:

These chemical gauge guards should be utilized to isolate and protect pressure or vacuum instruments used on ultra-pure or highly corrosive fluid lines. They can be confidently used with liquids such as demineralized water, sulphuric acid, hydrochloric acid, and caustics. Use caution with chlorine applications and consult factory for recommendations. Plast-O-Matic gauge guards offer the added advantage of protection against clogging of instruments caused by suspended solids or highly viscous fluids. Plast-O-Matic gauge guards are available with or without gauges.

MATERIALS OF CONSTRUCTION:

Gauge Guard housings are molded of Grade 1, Type 1, Geon® PVC, Corzan® CPVC, Natural Polypropylene, Glass-filled Polypropylene, or Kynar® PVDF. All materials are available with optional acrylic shields. PTFE diaphragms are standard with all assemblies using gauges of 0-30 PSI and greater. For 0-15 PSI and vacuum gauges FKM elastomer diaphragms are used.

Non-wetted parts: O-ring seals are buna-N, fasteners and ¼" instrument connections are stainless steel. ½" instrument connections are direct to upper housing material.

Standard Plast-O-Matic gauges have 304 stainless steel cases. Dials are aluminum with black markings on white backgrounds.

Threaded connections are stainless steel, pointers aluminum, and lenses heavy flat glass. Sensing elements are stainless steel bourdon tubes.

Liquid used to solidly fill all Plast-O-Matic gauge guards and instruments is a highly refined temperature stable mineral oil that complies with FDA regulations 21 CFR 172.878, 178.3620, and 573.680 or deionized water.

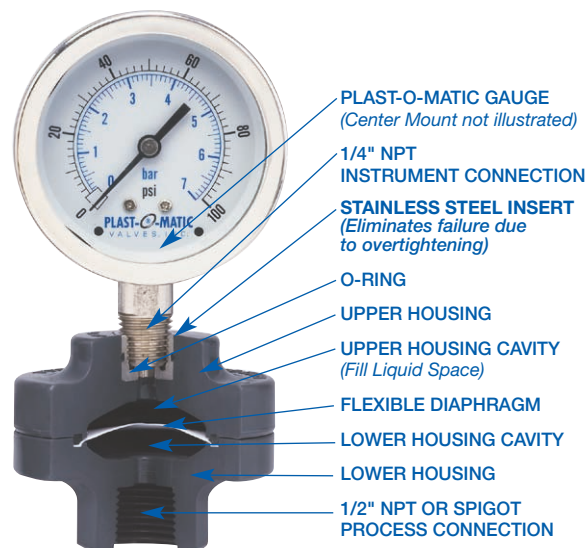

- PLAST-O-MATIC GAUGE
(Center Mount not illustrated)
- 1/4" NPT INSTRUMENT CONNECTION
- STAINLESS STEEL INSERT
(Eliminates failure due to overtightening)
- O-RING
- UPPER HOUSING
- UPPER HOUSING CAVITY
(Fill Liquid Space)
- FLEXIBLE DIAPHRAGM
- LOWER HOUSING CAVITY
- LOWER HOUSING
- 1/2" NPT OR SPIGOT PROCESS CONNECTION

OPERATION:

A Plast-O-Matic gauge guard assembled with a pressure or vacuum instrument must be solidly filled with a suitable fill liquid. The gauge guard diaphragm is a flexible barrier that prevents the process fluid from entering the instrument. Pressure on the process side of the diaphragm flexes it against the fill liquid transmitting the pressure to the instrument. Conversely, vacuum causes the diaphragm to flex in the opposite direction creating an equal vacuum in the fill liquid which actuates the instrument.

DESIGN:

Each Plast-O-Matic gauge guard features a durable and flexible diaphragm which serves as a protective barrier between the process fluid and instrument. The internal space on the instrument side of the diaphragm must be solidly filled with a suitable liquid in order to accurately transmit the process pressure to the instrument. Excellent flexing characteristics and a large sensing area (2.07 square inches) result in exceptional diaphragm response to low changes in pressure or vacuum. While PTFE diaphragms are standard, elastomer diaphragms are also available. This latter type is more sensitive and is used for vacuum or low pressure (0-15 PSI) applications. Another design feature is the volumetric capacity (1.03 Cu. In.) of the fill liquid side of diaphragm. This capacity, combined with flexible diaphragm, enables gauge guard to tolerate minor filling errors and minute air bubbles without loss of measuring accuracy. These chemical gauge guards are designed for a maximum working pressure of 250 PSI in most configurations. Additionally, if an instrument were to fracture or be accidentally removed from the upper housing and cause the loss of fill liquid, the diaphragm is strong enough to prevent leakage for a short time, of the process fluid up to the diaphragm's rupture point of approximately 400 PSI. If this situation should occur, immediately remove all process pressure from the gauge guard and replace the diaphragm as it has been exposed to abnormal stretching. Caution: If this safety feature is important (as with dangerous fluids such as acids) then a minimum of a 4 time safety factor should be adhered to and the process fluid pressure kept to 100 PSI or lower.

A design is also available whereby the upper assembly consisting of the instrument, fill liquid, and upper housing may be removed as a unit for the purpose of cleaning the process fluid side of the diaphragm and lower housing cavity without having to refill or recalibrate the instrument. See "Removable Housing Design" section for details.

INSTALLATION:

When Plast-O-Matic gauge guards are purchased with a gauge, install the assembly by simply connecting it to the process piping with a 1/2" NPT



plastic nipple using Teflon® tape or other acceptable pipe sealant to effect a seal. The assembly need only be made hand-tight followed by a one-quarter turn more with a strap wrench. Do not overtighten or breakage will result. Do not use pipe wrenches and do not install with a metal pipe nipple which could cut into the plastic and cause a fracture. For spigot or socket welding, follow system manufacturer's instructions. When purchased without a gauge, consult the "Filling Information" section first. When assembling a gauge or other instrument make sure to only tighten the 1/4" NPT connection until it is snug against the O-ring seal, DO NOT exceed 30 in. lbs., and follow the installation method in the previous paragraph.

In applications where it is necessary to remotely mount the gauge guard from the instrument, a capillary tube must be used. If the tube's inside diameter is 1/4" or larger and is not longer than 5 feet, it may be filled with the instrument as an assembly. Please consult "Filling Information" section. If the tube's inside diameter is smaller than 1/4" or if its length is greater than 5 feet, consult factory for filling instructions.

REMOVABLE HOUSING DESIGN:

The optional Plast-O-Matic removable housing design is recommended for applications where it is desirable to periodically clean the diaphragm of particulate or chemicals that might clog and prevent proper operation. It allows cleaning of the diaphragm and bottom housing without refilling or recalibrating the protected gauge or instrument. The cleaning process is possible only when there is no pressure or vacuum in the process line. While this removable housing design may be utilized with either lower or center back mounted gauges, it is not available with gauge shields. The gauge or instrument, fill liquid, diaphragm, and the upper housing to which they are attached can be removed without disconnecting the bottom housing from the process piping. This is achieved by loosening the 6 fasteners that hold the assembly together. Then remove the top housing by simply pulling it away from the lower housing. Since the 6 screws are threaded into the center retaining ring (A) the diaphragm and fill liquid will remain captured. When replacing the upper housing, care should be taken not to misalign the O-ring seal (B) located in the lower housing, otherwise leakage will result.

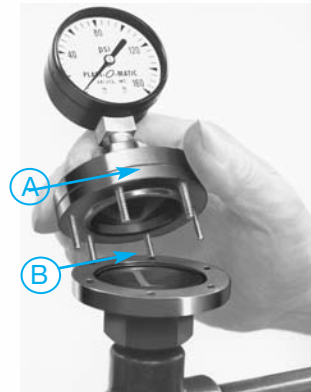

FACTORY-INSTALLED "SNUBBER" INSERT:

A recent Plast-O-Matic innovation is the addition of a "Snubber" insert. This optional feature reduces pressure pulsations, provides more accurate readings and reduces damage from excessive needle fluctuations, thereby extending the life of the gauge.

GAUGE SHIELDS:

Plast-O-Matic gauge guards are also available with transparent airtight and watertight acrylic shields to offer clear visibility while protecting metal gauges against corrosive atmospheres. They can be utilized as a protective shield against gauge damage caused by external shocks. These shields completely enclose metal gauges and fasteners utilizing an O-ring seal. They can only be used with 2" diameter or smaller gauges and they cannot be used with Plast-O-Matic gauge guards with the removable housing design.



GAUGES:

Standard Plast-O-Matic gauges have 2½" 304 stainless steel diameter faces and are available with either lower or center back mountings. Acrylic gauge shields (see gauge shield section) may be ordered if atmospheric corrosion is a concern. Use of the gauge shield requires smaller, optional 2" gauge. In general, the accuracy of standard Plast-O-Matic gauges when mounted to the Plast-O-Matic gauge guard assemblies and solidly filled is approximately 3%. For applications requiring extreme accuracy it is recommended that the assemblies be calibrated before installation to compensate for changes that may occur.



FILLING INFORMATION:

Plast-O-Matic gauge guards purchased with Plast-O-Matic gauges are factory filled. When purchased without a gauge, the installer must ensure that the upper gauge cavity and the gauge or instrument to be used must be solidly filled in order to accurately transmit the process line pressure or vacuum to the instrument. Air left in the fill liquid can give inaccurate readings; however, the volumetric capacity of 1.03 cubic inches, in conjunction with the flexible diaphragm, enables the assembly to tolerate minor filling errors without loss of pressure measurement accuracy.



Excellent flexing characteristics of the Plast-O-Matic diaphragm allows for a simple filling method when the gauge guard is used with a Plast-O-Matic or similar gauge. This is achieved by pouring the fill liquid into the upper housing cavity to the top of the threads. By tilting the housing in several positions the air should be

worked up and out of the housing. The same procedure can be used on the gauge although a small probe may be necessary to help evacuate the air bubbles. Because of the O-ring seal, thread sealant is not required on the instrument connection before it is threaded into the ¼" NPT stainless steel insert in the upper gauge guard housing. The fill liquid that is displaced by the pipe threads during mounting may deflect the diaphragm and thus cause an initial reading on the gauge. If a slight reading is present on the gauge or instrument after assembly it can be zeroed out by simply bleeding off a small amount of the fill liquid. To do this, partially unscrew the instrument and push a blunt rod against the diaphragm. This will cause the fill liquid to bleed out of the threads. Allow only a small amount of bleeding to take place and retighten the instrument. If a very sensitive instrument is to be protected by a Plast-O-Matic chemical gauge guard the instrument should be filled by a vacuum evacuation method. DO NOT fill the gauge guard by evacuation as vacuum will cause too much deflection of the diaphragm creating abnormal stretching.

The instrument should have a small enough orifice to retain the fill liquid when it is faced downward to be threaded into the gauge guard. If not, it may be necessary to tap the instrument's orifice and screw in a reducing bushing with a small orifice. This bushing should be removed before filling the instrument and replaced after filling.

ACCESSORY GAUGE GUARD FILL LIQUID:

Plast-O-Matic accessory fill liquid, available in 4 ounce bottles, is a highly refined mineral oil that complies with FDA regulations 21 CFR 172.878, 178.3620, and 573.680. It is temperature stable throughout our recommended temperature range, thus it will not cause errors in pressure measurement due to temperature differentials. It will remain stable indefinitely, and will not support anaerobic bacterial growth or react with the materials of the gauge guards or instruments. Plast-O-Matic fill liquid is recommended because its stability makes it more suitable than the other liquids for our range of applications, unless the mineral oil would have a dangerous reaction to the system fluid in the event of a diaphragm failure.

Standard gauge guards are designed with ¼" NPT for instrument connection and ½" NPT for the system connection. Other combinations are available optionally.

ALL-PLASTIC HOUSING OPTION:

Series GGS can be ordered without the stainless steel hex insert for applications where all-plastic is required. Consult factory.

OPTIONAL GAUGE FACE FILL:

Factory filled gauges can be filled with an FDA approved mineral oil or USP Food/Pharma grade glycerin. See page 6 for more information.

MAXIMUM GAUGES (PSI) RECOMMENDED AT GIVEN FLUID LINE TEMPERATURES*

LIQUID LINE TEMPERATURES**	77°F 22°C	104°F 40°C	140°F 60°C	158°F 70°C	185°F 85°C	212°F 100°C	239°F 115°C	284°F 140°C
GEON PVC	0-250 PSI	0-177 PSI	0-57 PSI	N/R	N/R	N/R	N/R	N/R
CORZAN® CPVC	0-250 PSI	0-200 PSI	0-140 PSI	0-95 PSI	0-60 PSI	N/R	N/R	N/R
NATURAL POLYPRO	0-160 PSI	0-130 PSI	0-80 PSI	0-65 PSI	0-40 PSI	N/R	N/R	N/R
GLASS-FILLED POLYPROPYLENE	0-160 PSI	0-160 PSI	0-160 PSI	0-100 PSI	0-60 PSI	N/R	N/R	N/R
KYNAR® PVDF	0-250 PSI	0-200 PSI	0-150 PSI	0-130 PSI	0-120 PSI	0-90 PSI	0-50 PSI	0-35 PSI

* Measurements conducted at a maximum ambient temperature of 80°F (26°C).

** If actual fluid line temperature is in between listed ratings, use the next column to the right for maximum recommended gauge.

FOR HDPE DIMENSIONS, SEE PAGE 5

GAUGE GUARDS & MODEL NUMBERS

TYPE OF SERVICE	FIG. NO.	AVAILABLE GAUGE RANGES AS SHOWN BARS		DIAPHRAGM MATERIALS	GAUGE GUARD MODEL NUMBERS
Pressure or Vacuum	1	Without Gauge		PTFE	GGTS1-PV**
Vacuum	1	0 - 30" HG	0 - 1.01 vac.	Viton FKM	GGVS000-PV
Pressure	1	0 - 15 PSI	0 - 1.04	Viton FKM	GGVS015-PV
Pressure	1	0 - 30 PSI	0 - 2.07	PTFE	GGTS030-PV
Pressure	1	0 - 60 PSI	0 - 4.14	PTFE	GGTS060-PV
Pressure	1	0 - 100 PSI	0 - 6.90	PTFE	GGTS100-PV
Pressure	1	0 - 160 PSI	0 - 11.04	PTFE	GGTS160-PV
Pressure	1	0 - 200 PSI	0 - 13.8	PTFE	GGTS200-PV

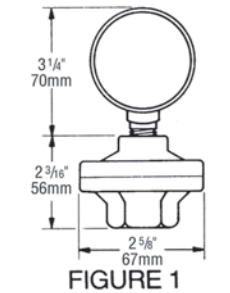

FIGURE 1

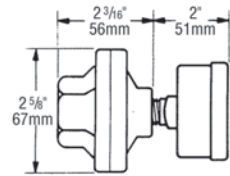

FIGURE 2

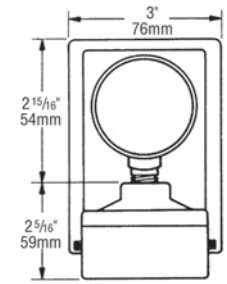

FIGURE 3

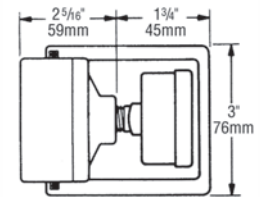

FIGURE 4

Part numbers shown are for Geon PVC. For Corzan CPVC, change suffix -PV to -CP. For Natural Polypro, change suffix -PV to -NP. For Glass-Filled Polypro change suffix -PV to PP. For Kynar PVDF, change suffix -PV to -PF. Example: GGTS1-PF. For spigot connection add SP1 (Asahi) SP2 (GF) or SP3 (IPS) after gauge designation. Example: GGTS160SP1-NP

* For other diaphragm materials, please consult factory.

** Viton FKM diaphragms used for additional sensitivity required on vacuum and low pressure (0-15 PSI) applications. When ordering Viton FKM in place of PTFE simply change the "T" in model number to "V".

ADDITIONAL MODEL NUMBER INFORMATION

If center back mounted gauge is ordered, conclude above model number with "-C" and use dimensional figure #2.

If a removable housing is ordered, conclude above model number with "-R" and add 1/4" to overall height of dimensional figure #1.

If both center back mounted gauge and removable housing are ordered, conclude above model number with "-CR" and add 1/4" to the overall height of dimension figure #2. Not available with Transparent Acrylic gauge shields.

If a Transparent Acrylic gauge shield is ordered, conclude above model number with "-S" and use dimensional figure #3.

If both center back mounted gauge and gauge shield are ordered, conclude above model number with "-CS" and use dimensional figure #4.

If glycerin filled gauge face is ordered, conclude above model number with "-G".

If fill port (see p. 7) is ordered, add "-FP" after material designation. Example: GGTS030-PV-FP

SEE PAGE 5 FOR SPIGOT DIMENSIONS

For Miniature Diaphragm Seal/Gauge Guard, see Catalog GGME. For Ultra-Pure Gauge Guards, see Catalog GGMU



Spigot Process Connection

- Standard spigot connection features Asahi or GF metric spigot for butt or socket fusion. IPS spigot for butt fusion only.
- Available in PVC (shown), CPVC, Natural Polypro, or PVDF. Seal materials are PTFE, EPDM, and FKM. EPDM diaphragms have glycerin or deionized water as fill liquid due to material compatibility.
- Available with or without gauge.

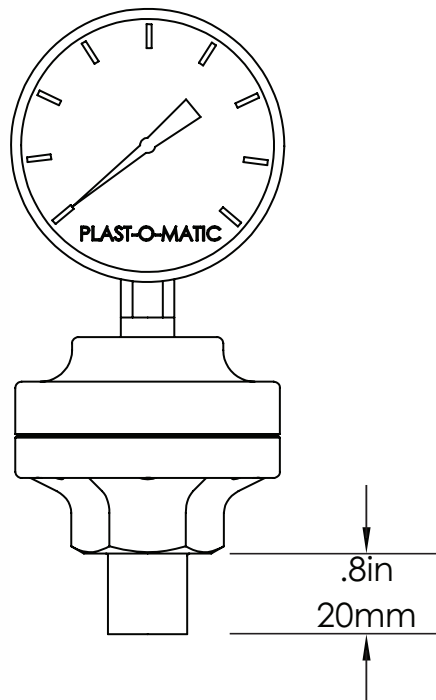

For spigot connection add SP1 (Asahi) SP2 (GF) or SP3 (IPS) after gauge designation. Example: GGTS160SP1-NP. See page 4 for complete part numbering and dimensional information.

Dimension may vary depending on connection type. Consult factory.

LIQUID FILLED GAUGE FACE OPTION



Plast-O-Matic stainless steel pressure & vacuum gauges are now available with a liquid-filled instrument face.

Standard liquid is USP Food/Pharma grade glycerin; add -G to the Series GGTS or GGMU part number. For other liquids, consult factory.

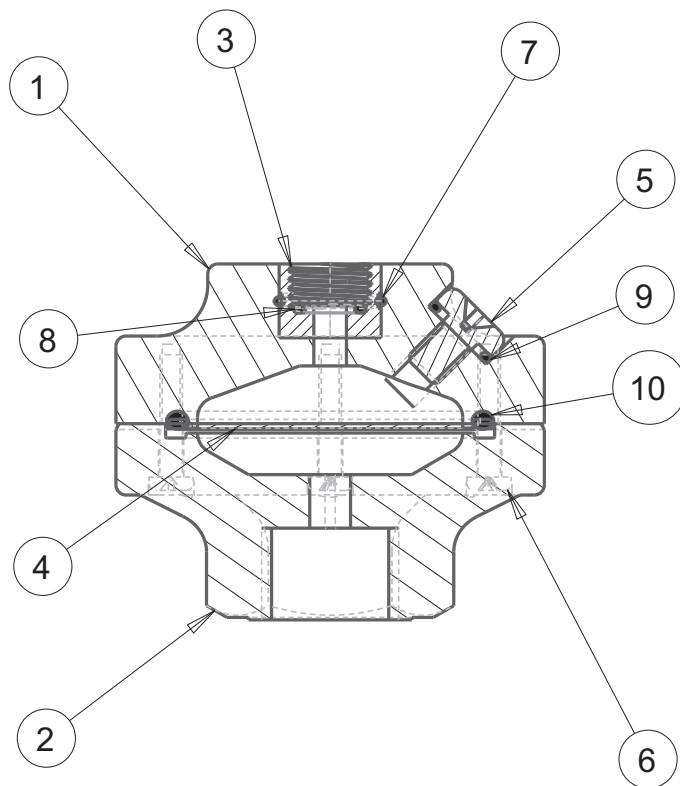

GAUGE GUARD FILL PORT

ITEM	QTY.	DESCRIPTION	MATERIAL
1	1	UPPER HOUSING	PVC
2	1	LOWER HOUSING	PVC
3	1	THREADED INSERT	SS
4	1	DIAPHRAGM	VITON
5	1	PAN HEAD SCREW	SS
6	6	PAN HEAD SCREWS	SS
7	1	O-RING	VITON
8	1	O-RING	VITON
9	1	O-RING	VITON
10	1	O-RING	VITON

For gauge fill port add -FP after material designation.
 Example: GGTS160-PV-FP. See page 4 for complete part numbering and dimensional information.