

**Operating Manual**  
**ALTAIR® 5X PID**  
**Multigas Detector**



Order No.: 10165710/10

Print Spec: 10000005389 (EO)

CR: 800000065121

**⚠ WARNING!**

These instructions must be provided to users before use of the product and retained for ready reference by the user. Read this manual carefully before using or maintaining the device. The device will perform as designed only if it is used and maintained in accordance with the manufacturer's instructions. Otherwise, it could fail to perform as designed, and persons who rely on this device could sustain serious injury or death.

---

The warranties made by MSA with respect to the product are voided if the product is not installed and used in accordance with the instructions in this manual. Please protect yourself and your employees by following the instructions.

Please read and observe the WARNINGS and CAUTIONS inside. For additional information relative to use or repair, call 1-800-MSA-2222 during regular working hours.

For countries of Russian Federation, Republic of Kazakhstan and Republic of Belarus, the gas detector will be delivered with a passport document that includes valid approval information. On the CD with manual instruction attached to the gas detector the user will find the documents "Type Description" and "Test Method" - appendixes to Pattern Approval Certificate of Measuring instrument, valid in the countries of use.

The Declaration of Conformity can be found under the following link: <https://MSAsafety.com/DoC>.

MSA is a registered trademark of MSA Technology, LLC in the US, Europe and other Countries. For all other trademarks visit <https://us.msasafety.com/Trademarks>.

This product incorporates Bluetooth® wireless technology. The Bluetooth word mark and logos are registered trademarks owned by Bluetooth SIG, Inc., and any use of such marks by MSA is under license. Other trademarks and trade names are those of their respective owners. Versions of this product manufactured July 2022 and later may not contain Bluetooth wireless technology. This will be indicated by the front case of the detector not utilizing a Bluetooth logo. All references in this manual to Bluetooth will not pertain to these versions of the device.



*The Safety Company*

1000 Cranberry Woods Drive  
Cranberry Township, PA 16066  
USA  
1-800-MSA-2222  
1-800-967-0398

For your local MSA contacts, please go to our website [www.MSAsafety.com](http://www.MSAsafety.com)

# Contents

<b>1</b>	<b>Calibration Certification and Conformance Statement</b>	<b>5</b>
1.1	Calibration Certification	5
1.2	Conformance Statement	5
<b>2</b>	<b>Safety Regulations</b>	<b>5</b>
2.1	Correct Use	5
2.2	Liability Information	6
2.3	Safety and Precautionary Measures	6
2.4	Warranty	8
<b>3</b>	<b>PID Theory and Definitions</b>	<b>9</b>
<b>4</b>	<b>Description</b>	<b>12</b>
4.1	Overview	12
4.2	Device Hardware Interfaces	13
4.3	Alarms	14
4.4	On-Screen Indicators	15
4.5	Viewing Additional Pages	18
4.6	Sensor Missing Alarm	22
4.7	Monitoring Toxic Gases	22
4.8	Monitoring Oxygen Concentration	23
4.9	Monitoring Combustible Gases	24
4.10	Monitoring VOC Gases	25
4.11	Displaying Current Response Factor	25
4.12	Calibration Certification	26
<b>5</b>	<b>Operation</b>	<b>26</b>
5.1	Environmental Factors	26
5.2	Turning ON and Fresh Air Setup	27
5.3	Special Consideration for Oxygen Sensor	29
5.4	Measurement Mode [Normal Operation]	30
5.5	Device Setup	30
5.6	Bluetooth Operation	38
5.7	MSA Link Operation	39
5.8	Function Tests on the Device	39
5.9	Bump Test	39
5.10	Calibration	41
5.11	Time of Day Testing	44
5.12	Device Shutdown	45
5.13	Manual Gas Check	45
<b>6</b>	<b>Maintenance</b>	<b>46</b>
6.1	Troubleshooting	46
6.2	Verifying Pump Operation	47
6.3	Replacing the Battery	47
6.4	Maintenance Procedure - Replacing or Adding a Sensor	48
6.5	Replacing the Pump Filter	50
6.6	Cleaning the Device Exterior	50
6.7	Storage	50
6.8	Shipment	50
6.9	PID Sensor Cleaning and Maintenance Procedure	51
<b>7</b>	<b>Technical Specifications</b>	<b>56</b>
7.1	Factory-Set Alarm Thresholds and Setpoints	57
7.2	Performance Specification	57
7.3	Calibration Specifications	60
7.4	Combustible Gas Cross Reference Factors for General-Purpose Calibration	61

---

<b>8</b>	<b>XCell Sensor Patents</b> .....	<b>62</b>
<b>9</b>	<b>Ordering Information</b> .....	<b>63</b>
9.1	US .....	63
9.2	Outside US .....	64
9.3	Accessories .....	64
9.4	Replacement Parts .....	66
<b>10</b>	<b>PID Response Factor Table</b> .....	<b>68</b>
<b>11</b>	<b>Flow Chart</b> .....	<b>74</b>
11.1	Basic Operation .....	74
11.2	Bump Test/ Informational Pages .....	75
11.3	Setup .....	77
11.4	Calibrations .....	78
11.5	Calibration Options .....	79
11.6	Alarm Options .....	80
11.7	Sensor Alarm Setup .....	81
11.8	Instrument Options .....	82
11.9	Sensor Setup .....	84
11.10	VOC Gas Setup .....	85
<b>12</b>	<b>Changeable Feature Summary</b> .....	<b>86</b>

## 1 Calibration Certification and Conformance Statement

### 1.1 Calibration Certification

All applicable inspections, testing, and calibrations were performed using NIST traceable equipment, where available, in accordance with MSA's ISO 9001 Certified Quality System. Each material, component, and/or instrument must be installed, operated and maintained in strict accordance with its labels, cautions, warnings, instructions, and within the limitations stated in the supplied instruction manual. Routine calibration checks, equipment inspections, and applicable preventative maintenance measures must be performed to verify that the materials, components, and/or instruments are operating properly. Failure to perform these tasks on a routine basis, or suggested intervals, with specified equipment or methods, may result in inaccurate readings.

### 1.2 Conformance Statement

MSA certifies that the materials, components, and/or instruments delivered in this shipment conform to all applicable specifications. The items delivered have been processed through the appropriate approved document controlled procedures for Receiving, Manufacturing and Inspection. The materials, components, and/or instruments were inspected, tested, and calibrated, as applicable, per the associated drawings, standards requirements, and/or specifications, and were deemed acceptable by appropriate authorized personnel.

## 2 Safety Regulations

### 2.1 Correct Use

The ALTAIR 5X PID Multigas Detector, hereafter also referred to as device, is for use by trained and qualified personnel. The device is designed to be used when performing a hazard assessment to:

- Assess potential worker exposure to combustible and toxic gases and vapors as well as low level of oxygen.
- Determine the appropriate gas and vapor monitoring needed for a workplace.

The ALTAIR 5X PID Multigas Detector can be equipped to detect:

- Combustible gases and certain combustible vapors.
- Volatile organic compounds (VOC).
- Oxygen-deficient or oxygen-rich atmospheres.
- Specific toxic gases for which a sensor is installed.
- CSA only: While the device can detect up to 30 % oxygen in ambient air, it is approved for use only up to 21% oxygen.

Outside the US: Oxygen for monitoring inertization applications. The device is suitable and certified for the measurement of the oxygen concentration in gas mixtures for inertization according to EN 50104 but without alarm function.

#### **WARNING!**

- The sensor in Replacement Kit P/N 10242735 may only be used with firmware revisions v6.00.xx or greater.
- Instruments with firmware revision less than v6.00.xx may not be used with the sensor included in Replacement Kit P/N 10242735.
- Sensor P/N 10165271 may only be used with firmware revisions less than v6.00.xx.
- Instruments with firmware revision v6.00.xx or greater may not be used with the sensor P/N 10165271.
- Perform a blocked flow test before each day's use.
- It is recommended that a Bump Test is performed before each day's use; adjust if necessary.
- For PID sensors manufactured from March 2020 to June 2023, a bump test or manual gas check must be performed each time that the unit is powered on.
- Perform a Bump Test more frequently if exposed to silicone, silicates, lead-containing compounds, hydrogen sulfide, or high contaminant levels.

## 2 Safety Regulations

---

- Recheck calibration if unit is subjected to physical shock.
- Use only to detect gases/vapors for which a sensor is installed.
- Do not use to detect combustible dusts or mists.
- For accurate catalytic combustible readings, make sure adequate oxygen is present (>10 % O<sub>2</sub>).
- Never block pump inlet, except to perform a sampling system safety test. Have a trained and qualified person interpret device readings. Risk of Explosion: Do not remove battery pack or recharge Li Ion battery in a hazardous location. Do not alter or modify device.
- Use only MSA-approved sampling lines.
- Do not use silicone tubing or sampling lines.
- Wait sufficient time for the reading; response times vary based on gas and length of sampling line.
- Properly identify the VOC gas being measured before using VOC response factors or setting alarm values (exposures, STEL, TWA)
- Recognize that the VOC display readings are in increments of 0.1 ppm from 0-999 ppm, then 1 ppm increments from 1000-2000 ppm with a Response Factor of one for the 0-2000 ppm PID sensor.
- Ensure installed PID lamp corresponds to the PID lamp setting on the display shown at startup.

**Failure to follow these warnings can result in serious personal injury or death.**

---

It is imperative that this operating manual be read and observed when using the product. In particular, the safety instructions, as well as the information for the use and operation of the product, must be carefully read and observed. Furthermore, the national regulations applicable in the user's country must be taken into account for safe use.

Alternative use, or use outside this specification will be considered as non-compliance. This also applies especially to unauthorized alterations to the product and to commissioning work that has not been carried out by MSA or authorized persons.

### 2.2 Liability Information

MSA accepts no liability in cases where the product has been used inappropriately or not as intended. The selection and use of this product must be under the direction of a qualified safety professional who has carefully evaluated the specific hazards of the jobsite where it will be used and who is completely familiar with the product and its limitations. The selection and use of this product and its incorporation into the safety scheme of the jobsite is the exclusive responsibility of the employer.

Product liability claims, warranties also as guarantees made by MSA with respect to the product are voided, if it is not used, serviced or maintained in accordance with the instructions in this manual.

### 2.3 Safety and Precautionary Measures

#### **WARNING!**

Carefully review the following safety limitations and precautions before placing this device in service.

**Failure to follow this warning can result in serious personal injury or death.**

---

- Check function ([5.8 Function Tests on the Device](#)) each day before use. MSA recommends carrying out a routine inspection prior to each day's use.
- It is recommended that a Bump Test is performed before each day's use ([5.9 Bump Test](#)) to verify proper device operation. The device must pass the bump test. If it fails the test, perform a calibration ([5.10 Calibration](#)) before using the device.
- For PID sensors manufactured from March 2020 to June 2023, a bump test or manual gas check must be performed each time that the unit is powered on.
- The ALTAIR 5X PID Detector is designed to detect gases and vapors in air only.

- Bluetooth Operation is dependent upon signal availability of the wireless service(s) necessary to maintain the communication link. Loss of wireless signal will prevent communication of alarms and other information to linked devices. Take appropriate precautions in the event a loss of wireless signal occurs.

### **WARNING!**

It is very important to have an understanding of PID basics when changing PID settings. Failure to properly identify the VOC gas being measured and/or failures to select the correct Response Factor alarm values (exposure, STEL, TWA) that match the desired Response Factor and/or the correct lamp will result in erroneous readings or erroneous alarm limits that could cause death or serious personal injury.

- Perform a Bump Test more frequently if the device is subjected to physical shock or high levels of contaminants. Also, check calibration more frequently if the tested atmosphere contains the following materials, which may desensitize the combustible gas sensor and/or VOC sensor (PID) and reduce its readings:
  - Organic silicones
  - Silicates
  - Lead-containing compounds
  - Sulfur compound exposures over 200 ppm or exposures over 50 ppm for one minute
  - High concentration of VOC gas may affect CO sensor performance
- The minimum concentration of a combustible gas in air that can ignite is defined as the Lower Explosive Limit (LEL). A combustible gas reading of **XXX** indicates the atmosphere is above 100 % LEL, and an explosion hazard exists. Move away from hazardous area immediately.
- Do not use the catalytic or electrochemical sensors to test for combustible or toxic gases in the following atmospheres as this may result in erroneous readings:
  - Oxygen-deficient or oxygen-rich atmospheres
  - Reducing atmospheres
  - Furnace stacks
  - Inert environments
  - Atmospheres containing combustible airborne mists/dusts.
- Do not use the catalytic combustible sensor of the ALTAIR 5X PID Multigas Detector to test for combustible gases in atmospheres containing vapors from liquids with a high flash point (above 38 °C, 100 °F) as this may result in erroneously low readings.
- Allow sufficient time for device to display accurate reading. Response times vary based on the type of sensor being utilized ([7.2 Performance Specification](#)). Allow a minimum of 1 second per foot (3 seconds per meter) of sample line to allow the sample to be drawn through the sensors.
- Sampling lines made from 0.062 inch (1.57 mm) inner diameter tubing provide fast transport times to the device; however, they must be limited to 50 feet (15 m) in length.
- Sampling of reactive toxic gases (Cl<sub>2</sub>, ClO<sub>2</sub>, NH<sub>3</sub>) must only be done with the reactive gas sample line and probe kits listed in [9 Ordering Information](#).
- Sampling lines made from 0.125 inch (3 mm) inner diameter tubing must be limited to 100 feet (30 m) in length.
- All device readings and information must be interpreted by someone trained and qualified in interpreting device readings in relation to the specific environment, industrial practice and exposure limitations.

### **Observe Proper Battery Maintenance**

Use only battery chargers made available by MSA for use with this device; other chargers may damage the battery pack and the device. Dispose of in accordance with local health and safety regulations.

## 2 Safety Regulations

### Be Aware of Environmental Conditions

A number of environmental factors may affect the sensor readings, including changes in pressure, humidity and temperature. Pressure and humidity changes also affect the amount of oxygen actually present in the atmosphere.

### Be Aware of the Procedures for Handling Electrostatically Sensitive Electronics

The device contains electrostatically sensitive components. Do not open or repair the device without using appropriate electrostatic discharge (ESD) protection. The warranty does not cover damage caused by electrostatic discharges.



This equipment has been tested and found to comply with the limits for a Class A digital device, pursuant to part 15 of the FCC Rules. These limits are designed to provide reasonable protection against harmful interference when the equipment is operated in a commercial environment. This equipment generates, uses, and can radiate radio frequency energy and, if not installed and used in accordance with the instruction manual, may cause harmful interference to radio communications. Operation of this equipment in a residential area is likely to cause harmful interference in which case the user will be required to correct the interference at his own expense.

This device complies with part 15 of the FCC Rules. Operation is subject to the following conditions: (1) This device may not cause harmful interference, and (2) this device must accept any interference received, including any interference that may cause undesired operation.

### WARNING!

This is a class A product in accordance with CISPR 22. In a domestic environment, this product may cause radio interference, in which case the user may be required to take adequate measures.

**Failure to follow this warning can result in serious personal injury or death.**

This Class A digital apparatus complies with Canadian ICES-003.

### Be Aware of the Warranty Regulations

The warranties made by MSA The Safety Company with respect to the product are voided if the product is not used and maintained in accordance with the instructions in this manual. Please protect yourself and others by following them. We encourage our customers to write or call regarding this equipment prior to use or for any additional information relative to use or service.

### Be Aware of the Product Regulations

Follow all relevant national regulations applicable in the country of use.

## 2.4 Warranty

ITEM	WARRANTY PERIOD*
Chassis and electronics	Three years
XCell COMB EX, O <sub>2</sub> , H <sub>2</sub> S, CO, SO <sub>2</sub> , NO <sub>2</sub> ** , and IR sensors	Three years
XCell Cl <sub>2</sub> , NH <sub>3</sub> sensors	Two years
Series 20 ClO <sub>2</sub> , HCN, NO, NO <sub>2</sub> ***, PH <sub>3</sub> sensors	One year
PID sensors	One year
In-Box Accessories Including Replacements	Two years

\*period begins date of received shipment

\*\*Only available in sensor #2 or #4 position

\*\*\*Only available in sensor #3 position

This warranty does not cover filters, fuses, etc. As the battery pack ages, there will be a reduction in usable device run time. Certain other accessories not specifically listed here may have different warranty periods. This warranty is valid only if the product is maintained and used in accordance with Seller's instructions and/or recommendations.



The Seller shall be released from all obligations under this warranty in the event repairs or modifications are made by persons other than its own or authorized service personnel or if the warranty claim results from physical abuse or misuse of the product. No agent, employee or representative of the Seller has any authority to bind the Seller to any affirmation, representation or warranty concerning this product. Seller makes no warranty concerning components or accessories not manufactured by the Seller, but will pass on to the Purchaser all warranties of manufacturers of such components.

**THIS WARRANTY IS IN LIEU OF ALL OTHER WARRANTIES, EXPRESSED, IMPLIED OR STATUTORY, AND IS STRICTLY LIMITED TO THE TERMS HEREOF. SELLER SPECIFICALLY DISCLAIMS ANY WARRANTY OF MERCHANTABILITY OR OF FITNESS FOR A PARTICULAR PURPOSE.**

#### **Exclusive Remedy**

It is expressly agreed that Purchaser's sole and exclusive remedy for breach of the above warranty, for any tortious conduct of Seller, or for any other cause of action, shall be the replacement at Seller's option, of any equipment or parts thereof, which after examination by Seller is proven to be defective.

Replacement equipment and/or parts will be provided at no cost to Purchaser, F.O.B. Seller's Plant. Failure of Seller to successfully replace any nonconforming equipment or parts shall not cause the remedy established hereby to fail of its essential purpose.

#### **Exclusion of Consequential Damage**

Purchaser specifically understands and agrees that under no circumstances will seller be liable to purchaser for economic, special, incidental or consequential damages or losses of any kind whatsoever, including but not limited to, loss of anticipated profits and any other loss caused by reason of non-operation of the goods. This exclusion is applicable to claims for breach of warranty, tortious conduct or any other cause of action against seller.

### **3 PID Theory and Definitions**

To support the safe and effective operation of the ALTAIR 5X PID, MSA believes operators should have a working knowledge of how the device functions, not just how to make it work. The information presented in this section supplements the hands-on operational instruction provided in the rest of the manual for the PID.

#### **PID Theory**

A photoionization detector (PID) uses an ultraviolet lamp to ionize the compound of interest. A current is produced in proportion to the concentration of the VOC present, and the concentration of the compound is shown on the device display.

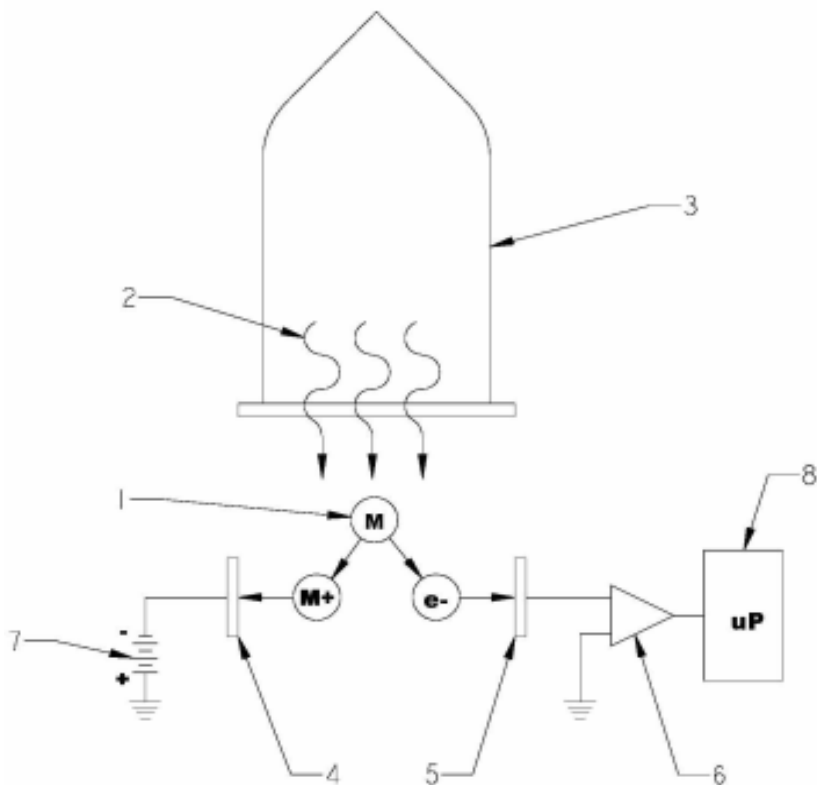

Figure 1 Typical photoionization sensor design

- |                                                   |                  |
|---------------------------------------------------|------------------|
| 1 Molecules of Interest                           | 5 Electrodes     |
| 2 High energy Vacuum Ultra Violet (VUV) radiation | 6 Amplifier      |
| 3 UV lamp                                         | 7 DC Source      |
| 4 Electrodes                                      | 8 Microprocessor |

#### Zero Gas

Zero gas is a reference gas used during calibration to zero the device. When a zero gas with no hydrocarbon content is introduced to the device, the detector will still respond with a small signal. This signal is a result of secondary background processes. During calibration, zero gas is applied to quantify the background ionization current. When only measuring concentration changes relative to a reference ambient environment, fresh air can be used as the zero gas. When background hydrocarbon vapors are present, MSA recommends using zero gas air.

#### Span Gas

Span gas is a reference gas used during calibration to determine the slope (response per unit concentration) of the calibrated response curve.

For the 0-2000 ppm PID sensor the only allowable calibration gas is 100 ppm isobutylene.

See [5.10 Calibration](#) for calibration instructions.

#### Response Factors

When a compound is ionized by photoionization, the ionized molecules are collected and converted to a current. This response is a characteristic property of the specific compound which is influenced by its molecular structure. The slope of the response curve (defined in picoamperes per ppm) is different for different chemicals. To properly report the concentration for a given sample gas, the ALTAIR 5X PID uses response factors. See [10 PID Response Factor Table](#), for instructions on using the pre-programmed list of response factors.

**⚠ WARNING!**

It is very important to have an understanding of PID basics when changing PID settings. Failure to properly identify the VOC gas being measured and/or failures to select the correct Response Factor alarm values (exposure, STEL, TWA) that match the desired Response Factor and/or the correct lamp will result in erroneous readings or erroneous alarm limits that could cause death or serious personal injury.

The response factor is defined as the ratio of the detector response for isobutylene to the detector response for the sample gas. Response factors for a wide range of substances have been determined experimentally. These response factors are programmed into the device. Note that the calibrated response curve, and all programmed response factors are relative to isobutylene. Isobutylene has a response factor of one.

The response factor is a multiplier that compensates for the difference between the response of the sample gas and the response of isobutylene at 100ppm. Whenever the device detects the presence of a VOC, it uses the response factor for the user-assigned target gas to convert the signal to the correct, concentration. This is done by multiplying the equivalent isobutylene response by the response factor for the set sample gas. The isobutylene response curve is calculated at every calibration.

If the response factor is known, a device calibrated with isobutylene can be used to calculate the actual concentration of a target gas.

**Calculating a Response Factor**

To determine a response factor for a target chemical, perform the following simple procedure:

1. Calibrate the ALTAIR 5X PID using isobutylene as the span gas.
2. On the device, set the sample gas name to isobutylene.
3. Apply a known concentration of the target chemical to the device and note the concentration reported in the display.

The response factor for the target chemical relative to isobutylene:

$$RF_{\text{target gas}} = \frac{\text{Actual known concentration}}{\text{Concentration reported by device}}$$

**For example:**

An operator is using a device that has been calibrated on isobutylene. The sample gas is set to isobutylene. While using this device to sample for hexane, the display reads 100 ppm. Since the response factor for hexane is 4.5, the actual concentration of hexane is:

$$\text{Actual hexane concentration} = 4.5 \times 100 \text{ ppm} = 450 \text{ ppm.}$$

**For example:**

A device is calibrated on isobutylene, and has isobutylene defined as the sample gas. When sampling 106 ppm of benzene in air, the device reports a concentration of 200 ppm. In this example, the response factor for benzene relative to isobutylene would be:

$$RF_{\text{benzene}} = \frac{106 \text{ ppm known concentration benzene}}{200 \text{ ppm reported}} = 0.53$$

When surveying, if benzene is selected as the sample gas in the Response Factor page, 0.53 will be used by the device as a response factor. The device will use this response factor to automatically correct the displayed concentration into PPM benzene. A target gas with a response factor between zero and one implies that the device has a higher detector response for that gas when compared to isobutylene. If the response factor is greater than one, the device has a lower detector response for this gas when compared to isobutylene.

**⚠ WARNING!**

It is very important to select the correct lamp setting during PID setup since PID response factors for a target chemical relative to isobutylene are different depending on what energy PID lamp is installed. See [5.5 Device Setup](#) for setup instructions.

**Failure to follow this warning can result in inaccurate readings that could lead to serious injury or death.**

## 4 Description

### 4.1 Overview



Figure 2 Device view

#### LEDs

- |   |                                                    |    |                         |
|---|----------------------------------------------------|----|-------------------------|
| 1 | 2 red "Alarm", 1 green "Safe" and 1 yellow "Fault" | 8  | IRDA communication port |
| 2 | Horn                                               | 9  | Pump inlet              |
| 3 | Display                                            | 10 | Filter                  |
| 4 | ▲ Button                                           | 11 | RFID tag                |
| 5 | ⏻ Button                                           | 12 | Charging port           |
| 6 | ▼ Button                                           | 13 | Charge Status LED       |
| 7 | Bluetooth Status LED                               |    |                         |

The device monitors gases in ambient air and in the workplace.

The ALTAIR 5X PID is available with a maximum of five sensors, which can display readings for six separate gases (one Two-Tox Sensor provides both CO and H<sub>2</sub>S or CO and NO<sub>2</sub> sensing capabilities in a single package).

The alarm levels for the individual gases are factory-set and can be changed through the Instrument Setup Menu. These changes can also be made through MSA Link Software. Ensure that the latest version of the MSA Link software has been downloaded from MSA's website [www.msasafety.com](http://www.msasafety.com).

It is recommended that after making changes using MSA Link software, the device should be turned OFF and ON.







While the device can detect up to 30% oxygen in ambient air, it is approved for use only up to 21% oxygen.



## 4.2 Device Hardware Interfaces

Device operation is dialog driven from the display with the aid of the three function buttons ( [Figure 2](#) ).

The device has three buttons for user operation. Each button can function as a "soft key," as defined on the display directly above the button.

### Button Definitions

Button	Description
	The  button is used to turn the device ON or OFF and to confirm user action selections.
	The  button is used to page down through data screens or to decrease the values in setup mode. This button is also used to initiate a Bump Test for the installed sensors, directly from the MEASURING page. If the user is granted access to the MotionAlert setting feature, this button can be used to activate the InstantAlert™ alarm.  See <a href="#">5.5 Device Setup</a> for the means to allow/disallow user access.
	The  button is used to reset Peak, STEL, TWA and alarms (where possible) or perform calibration in measuring mode. It is also used as page up or to increase the values in setup mode.

When the  button and the  button are pressed simultaneously while in normal measure mode, the Setup mode can be entered after the password is confirmed.





### LED Definitions

LED	Description
<b>RED</b> (Alarm)	The red alarm LEDs are visual indications of an alarm condition or any type of error in the device.
<b>GREEN</b> (Safe)	The Safe LED flashes once every 15 seconds to notify the user that the device is ON and operating under the conditions defined below: <ul style="list-style-type: none"> <li>• The green SAFE LED is enabled</li> <li>• Combustible reading is 0 % LEL or 0 % Vol</li> <li>• Oxygen (O<sub>2</sub>) reading is 20.8 %</li> <li>• All other sensor readings are 0 ppm</li> <li>• No gas alarms are present (low or high)</li> <li>• Device is not in Low Battery warning or alarm</li> <li>• STEL and TWA readings are 0 ppm</li> </ul> This option can be turned OFF through the MSA Link software.
<b>YELLOW</b> (Fault)	The Fault LED activates if any of several fault conditions are detected during device operation. This includes: <ul style="list-style-type: none"> <li>• A device memory error</li> <li>• A sensor determined to be missing or inoperative</li> <li>• A pump fault</li> </ul> These faults are also indicated by activation of device alarm LEDs, horn, and vibrating alarm.
<b>BLUE</b> (Bluetooth Status)	The blue LED is a visual indication of the Bluetooth connection status. <ul style="list-style-type: none"> <li>• Off = Bluetooth board OFF or Undiscoverable</li> <li>• Fast Flash = Discoverable Mode</li> <li>• Slow Flash = Connected</li> </ul>

## 4 Description

### 4.3 Alarms

The device is equipped with multiple alarms for increased user safety:

Icon	Alarm	
	Vibrating Alarm	The device vibrates when any alarm condition is active. This can be turned OFF through the SETUP- ALARM OPTIONS menu (→ Device Setup).
	Horn	The device is equipped with an audible alarm.  The horn can be turned OFF through the SETUP- ALARM OPTIONS menu (→Device Setup).
	InstantAlert™ Alarm	The InstantAlert exclusive feature allows the user to manually activate an audible alarm to alert those nearby to potentially dangerous situations. Holding the ▼ button for approximately 5 seconds while in Normal Measure Mode activates the InstantAlert alarm. Access to this feature may be restricted by user settings. See <a href="#">5.5 Device Setup</a> for means to allow/disallow user access.
	MotionAlert™ Alarm	If MotionAlert is turned ON (→ <a href="#">5.5 Device Setup</a> ), the device activates a "Man Down" alarm if motion is not detected within 30 seconds. The Alarm LEDs flash, and the horn activates with an increasing audible frequency. MotionAlert is always turned OFF when the device is turned OFF.  Access to this feature may be restricted by user settings. See <a href="#">5.5 Device Setup</a> for means to allow/disallow user access.
	Stealth Mode	Stealth Mode disables the visual, audible and vibrating alarms. MSA recommends that this feature be left in its default "OFF" state. Stealth mode can be turned ON through the SETUP - INSTRUMENT OPTIONS menu (→ Device Setup). On the display, all three alarm icons are shown as OFF.
	Sensor Life Alarm	The device evaluates the condition of the sensors during Calibration.  As the end of a sensor's life approaches, a warning is provided. While the sensor is still fully functional, the warning gives the user time to plan for a replacement sensor to minimize downtime. The Sensor Life indicator ♥ displays during ongoing operations as a reminder of a sensor's pending end of life.  When a sensor's end-of-life is reached, sensor calibration will not be successful, and the user is then alerted by a Sensor Life Alarm. A flashing Sensor Life indicator ♥ displays during ongoing operations until the sensor is replaced and/or successfully calibrated.  On the display, each displayed gas will have its own Sensor Life indicator. If a sensor is in end-of-life warning, its indicator will be an orange ♥. If a sensor has reached end-of-life, it is in alarm and its Sensor Life indicator will be a ♥.  See <a href="#">5.10 Calibration</a> for additional details on Sensor Life determination and indication.
	Backlight	The backlight automatically activates when any front panel button is pressed and remains ON for the duration of user-selected timeout.  This duration can be changed using the SETUP - INSTRUMENT SETUP (→ Device Setup) or through MSA Link software.
	Operating Beep	This operating beep activates every 30 seconds by momentarily beeping the horn and flashing the alarm LEDs under the following conditions: <ul style="list-style-type: none"> <li>• Operating beep is enabled</li> <li>• Device is on normal Measure Gases page</li> <li>• Device is not in battery warning</li> </ul>

Icon	Alarm	
		<ul style="list-style-type: none"> <li>• Device is not in gas alarm.</li> </ul> <p>The Operating Beep can be disabled using the SETUP - INSTRUMENT OPTIONS (→<a href="#">5.5 Device Setup</a>) or through MSA Link software.</p>

#### 4.4 On-Screen Indicators

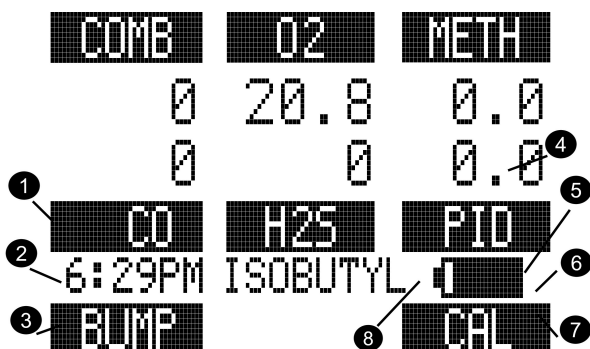

Figure 3 Monochrome Display

- |                          |                                               |                          |
|--------------------------|-----------------------------------------------|--------------------------|
| 1 Gas Type               | 5 Battery Condition                           | 8 + MotionAlert (+ = ON) |
| 2 Current Time           | 6 Successful Bump Test/ Calibration Indicator | ♥ Sensor Life Indicator  |
| 3 "Soft Key" ▼ Indicator | 7 "Soft Key" ▲ Indicator                      | ✱ Bluetooth On/Off       |
| 4 Gas Reading            |                                               |                          |

On a monochrome display, a message appears every 30 seconds if the Vibration, Horn, or LED alarms are turned OFF.

## 4 Description

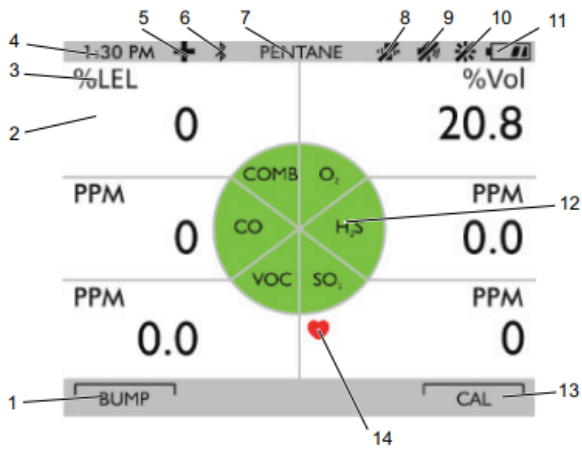

Figure 4 Color Display

1	"Soft Key" ▼ Indicator	8	Vibration Alarm OFF
2	Gas Reading	9	Horn OFF or successful Bump Test / Calibration Indicator
3	Gas Concentration Units	10	LED OFF
4	Current Time	11	Battery Charge Level
5	Motion Alert symbol ON	12	Gas Type
6	Wireless USB or Bluetooth ON	13	"Soft Key" ▲ Indicator
7	Combustible Gas/VOC type	14	Sensor Life Indicator

### Battery Charge Level Indicator

The battery condition icon continuously displays in the upper right-hand corner of the display. A bar represents the charging level of the battery.

The nominal run-time of the device (COMB, O<sub>2</sub>, CO, H<sub>2</sub>S, and PID sensor) at room temperature is 12 hours. Actual run-time will vary depending on ambient temperature, battery and alarm conditions.

### Low Battery Warning

#### WARNING!

If battery warning alarm activates while using the device, leave the area immediately as the end of battery life is approaching.

**Failure to follow this warning can result in serious personal injury or death.**



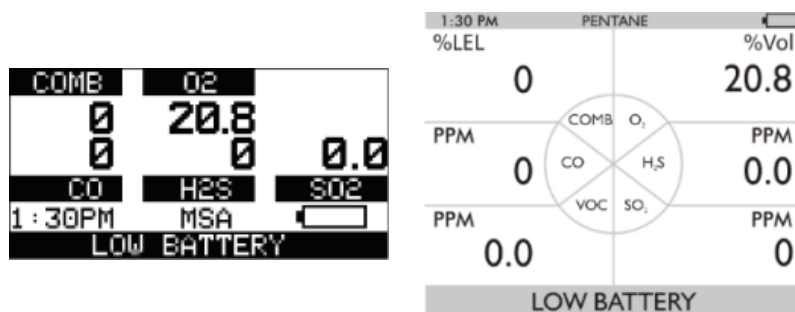

Figure 5 Battery Warning

The duration of remaining device operation during a Low Battery Warning depends on ambient temperatures, battery condition alarm status. Nominal battery life is 30-60 minutes after the Battery Warning activates.

When the device goes into battery warning the:

- battery life indicator continuously blinks
- alarm sounds and alarm LEDs flash every 30 seconds
- Safe LED no longer flashes
- device continues to operate until it is turned OFF or battery shutdown occurs.

### Battery Shut Down

#### **⚠ WARNING!**

If battery alarm displays, stop using the device as it no longer has enough power to indicate potential hazards, and persons relying on this product for their safety could sustain serious personal injury or death.

The device goes into battery shutdown mode 60 seconds before final shutdown (when the batteries can no longer operate the device):

- "BATTERY ALARM" flashes on the display
- Alarm sounds
- Alarm LEDs flash
- Fault LED is on
- No other pages can be viewed; after approximately one minute, the device automatically turns OFF.

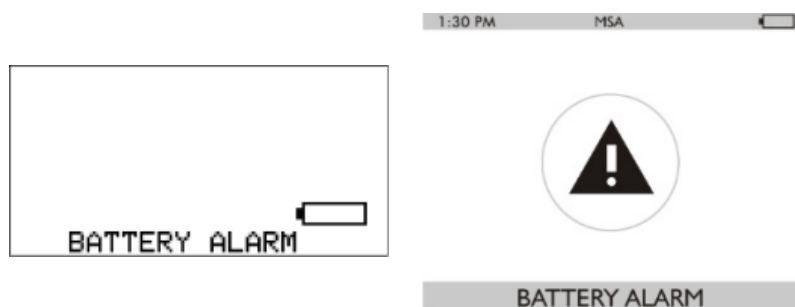

Figure 6 Battery Shut Down

When battery shutdown condition occurs (shown in [Figure 6](#)):

1. Leave the area immediately.
2. Recharge or replace the battery pack.

### Battery Charging

#### **WARNING!**

Risk of explosion: Do not recharge device in hazardous area.

**Failure to follow this warning can result in serious personal injury or death.**

---

#### **WARNING!**

Use of any charger, other than the charger supplied with the device, may damage or improperly charge the batteries.

---



For users in Australia/ New Zealand: The charge cradle is a Class A product. In a domestic environment, this product may cause radio interference, in which case, the user may be required to take adequate measures.

---

The charger is capable of charging a completely depleted pack in less than six hours in normal, room-temperature environments.

---



Allow very hot or cold devices to stabilize for one hour at room temperature before attempting to charge.

---

- Minimum and maximum ambient temperature to charge the device is 10 °C (50 °F) and 35 °C (95 °F), respectively.
- For best results, charge the device at room temperature 23 °C (73 °F).

### To Charge the Device

- Firmly insert the charger connector into the charge port on the back of the device.
  - An LED in the battery pack is used to indicate on the charge status.  
Red = charging, Green = charged, yellow = fault
  - If a problem is detected during charging (LED turns yellow):  
Disconnect the charger momentarily to reset the charge cycle.
  - The battery pack may be charged separately from the device.
  - During periods of non-use, the charger may remain connected to the device/battery pack.
- 



The charger must be disconnected for the device to operate.

---

### 4.5 Viewing Additional Pages

The Main Screen appears at device turn-ON.

Additional displays can be viewed by pressing the ▼ button to move to the screen as indicated by the "soft key".

The sequence of pages are as follows and are described in [Figure 7](#) :

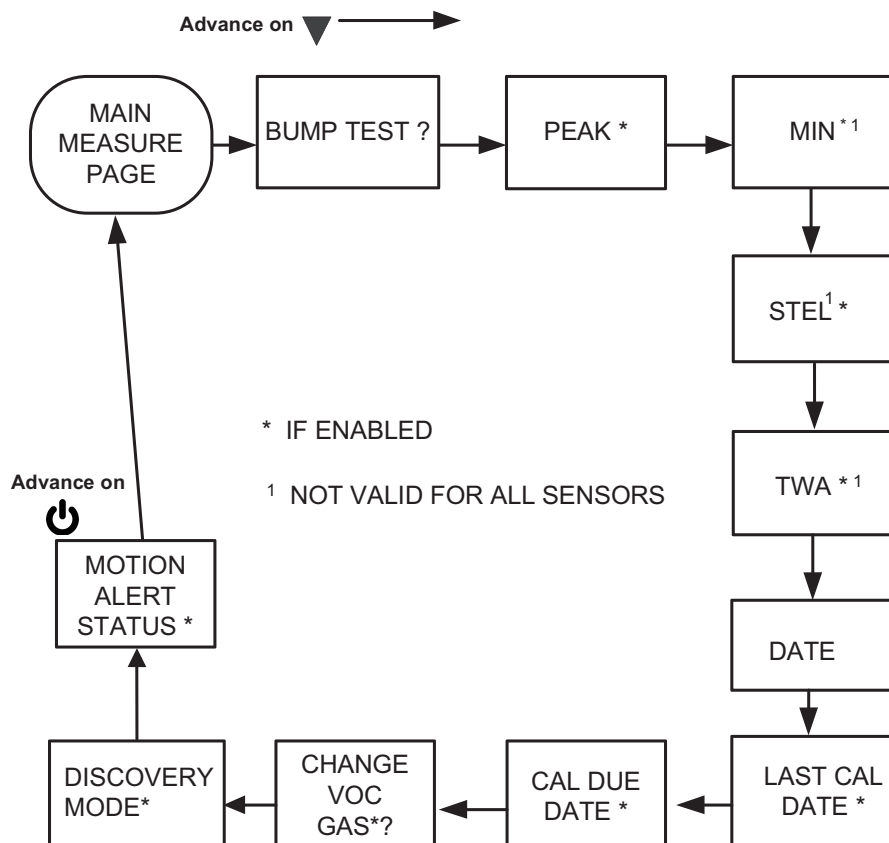

Figure 7 Sequence of pages

### Bump Test (BUMP page)

This page allows the user to perform an automated Bump Test on the device. To perform the test, the (YES) button is pressed. See [5.9 Bump Test](#) for details on performing the Bump Test.

If the ▼ button is pressed, the Bump Test is not performed, and the display shows the next page in the sequence (PEAK).

If the ▲ button is pressed, the Bump Test is not performed, and the display reverts back to the normal MEASURE page.

### Peak Readings (PEAK page) ▲▲

This page shows the highest levels of gas recorded by the device since turn-ON or since peak readings were reset.

To reset the peak readings:

1. Access the PEAK page.
2. Press the ▲ button.



This page can be de-activated through MSA Link software.

### Minimum Readings (MIN page) ▲▲

This page shows the lowest level of oxygen recorded by the device since turn-ON or since the MIN reading was reset. It is only shown if an oxygen sensor is installed and enabled.

To reset the MIN reading:

1. Access the MIN page.
2. Press the ▲ button.

## 4 Description

### Short Term Exposure Limits (STEL page)

#### **WARNING!**

If the STEL alarm activates, leave the contaminated area immediately; the ambient gas concentration has reached the preset STEL alarm level.

**Failure to follow this warning will cause over-exposure to toxic gases and persons relying on this product for their safety could sustain serious personal injury or death.**

This page shows the average exposure over a 15-minute period.

When the amount of gas detected by device is greater than the STEL limit:

- Alarm sounds, alarm lights flash.
- Alarm LEDs flash
- "STEL ALARM" message flashes.

To reset the STEL:

3. Access the STEL page.
4. Press the ▲ button.

The STEL alarm is calculated over a 15-minute exposure.

STEL calculation examples:

Assume the device has been running for at least 15 minutes:

#### **15 minute exposure of 35 ppm:**

(15 minutes x 35 ppm)	= 35 ppm
15 minutes	

#### **10 minute exposure of 35 ppm and 5 minutes exposure of 15 ppm:**

(10 minutes x 35 ppm) + (5 minutes x 5 ppm)	= 25 ppm
15 minutes	



This page can be de-activated through MSA Link software.

### Time Weighted Average (TWA page)

#### **WARNING!**

If the TWA alarm activates, leave the contaminated area immediately; the ambient gas concentration has reached the preset TWA alarm level.

**Failure to follow this warning will cause over-exposure to toxic gases and persons relying on this product for their safety could sustain serious personal injury or death.**

This page shows the average exposure over 8 hours since the device was turned ON or since the TWA reading was reset. When the amount of gas detected is greater than the eight-hour TWA limit:

- Alarm sounds
- Alarm LEDs flash
- "TWA ALARM" message flashes.

To reset the TWA Readings:

1. Access the TWA page.
2. Press the ▲ button.

The TWA alarm is calculated over an eight-hour exposure.

TWA calculation examples:

**1 hour exposure of 50 ppm:**

(1 hour x 50 ppm) + (7 hours x 0 ppm)	= 6.25 ppm
8 hours	

**4 hour exposure of 50 ppm and 4 hour exposure of 100 ppm:**

(4 hours x 50 ppm) + (4 hours x 100 ppm)	= 75 ppm
8 hours	

**12 hour exposure of 100 ppm:**

(12 hours x 100 ppm)	= 150 ppm
8 hours	



This page can be de-activated through MSA Link software.

**Date Display**

Current date appears on the display in the format: **MM-DD-YY**.

**Last cal page**

Displays the device last successful calibration date in the format: **MM-DD-YY**. This page can be de-activated through MSA Link software or the SETUP - CAL OPTIONS page.

**Cal due page**

Displays the days until the device's next calibration is due (user selectable). This page can be de-activated through MSA Link software or the SETUP - CAL OPTIONS page.

**Discoverable Mode page**

Allows the user to put the device into Bluetooth discoverable mode in order to pair with another device. This page can be deactivated through the SETUP - INSTRUMENT OPTIONS page.

**Change VOC Gas? Page**

This page is selectable if the "Menu Enable" feature is ON as described in [5.5 Device Setup](#). This page contains the 10 Favorite PID gases, the All Gases list and the Custom Gas list. An example of this screen is shown below:

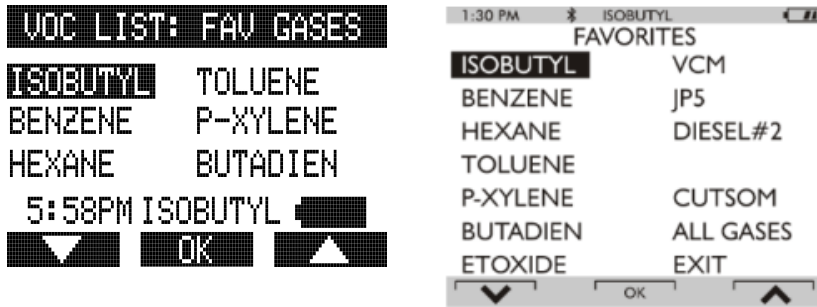

Figure 8

### Motion Alert Activation Page

When the MotionAlert feature is active, the + symbol appears. The device enters pre-alarm when no motion is detected for 20 seconds. This condition can be cleared by moving the device. MotionAlert is turned OFF each time the device is powered OFF. After 30 seconds of no motion, the full MotionAlert alarm is triggered. This alarm can only be cleared by pressing the ▲ button. This page displays if it was selected in Setup Mode. To activate or deactivate the MotionAlert feature, press the ▲ button while the MOTIONALERT ACTIVATION page is displayed.

### 4.6 Sensor Missing Alarm

Enabled PID and XCell sensors are continuously monitored for proper function. If, during operation, the PID or an XCell sensor is detected as failed or disconnected, this alarm message appears.

- "SENSOR MISSING" flashes on the display.
- The problematic sensor is indicated.
- The alarm sounds and the Fault and Alarm LEDs flash.
- The alarm can be silenced by pressing the ▲ button; no other pages can be viewed.

### WARNING!

When this alarm occurs, the device is inoperative for measuring gases. The user must exit the hazardous area, the device must be powered down, and the sensor situation must be corrected.

**Failure to follow this warning can result in serious personal injury or death.**

### 4.7 Monitoring Toxic Gases

The device can monitor the concentration of a variety of toxic gases in ambient air. Which toxic gases are monitored depends on the installed sensors.

The device displays the gas concentration in parts per million (ppm),  $\mu\text{mol/mol}$  or  $\text{mg/m}^3$  on the Measuring page. Gas units are selected in the SETUP - INSTRUMENT OPTIONS page.

### WARNING!

If an alarm is triggered while using the device, leave the area immediately.

**Failure to follow this warning can result in serious personal injury or death.**

The device has four gas alarms:

- HIGH Alarm
- LOW Alarm
- STEL Alarm
- TWA Alarm

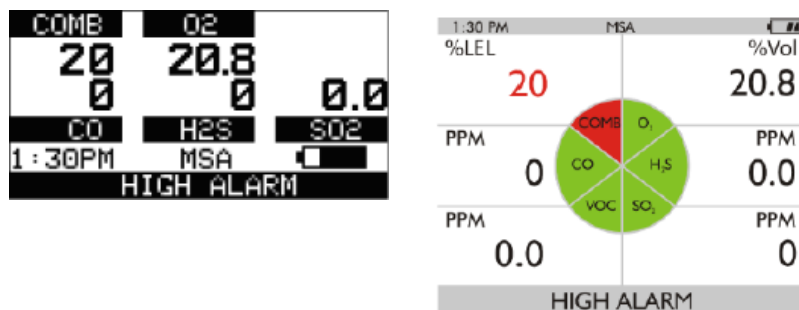

Figure 9 Alarm Conditions (here High Alarm)

The carbon monoxide channel in the device is equipped with an internal filter. The purpose of this filter is to protect the CO sensor from acid gases ( $\text{H}_2\text{S}$ ,  $\text{SO}_2$ , etc.) and from the hydrocarbons that the device is intended to measure, including the calibration gas, isobutylene. In normal use, an interferent signal for calibration or bump checking the device should not be observed on the CO channel. However, exposure to large amounts of certain hydrocarbons (either long exposure times or high concentrations) can overwhelm the filter and appear as signals on the CO channel.

In normal operation, after the hydrocarbon exposure is ended, the filter is designed to outgas absorbed hydrocarbons at a rate that will not cause a signal on the CO channel. However, if the unit is exposed to high temperature ( $>40^\circ\text{C}$ ), this desorption rate increases and spurious signals may be observed on the CO channel due to gassing of previously absorbed hydrocarbons. Typically the CO sensor will recover within 24 hours but extremely high exposures can extend this time. After the recovery period if the CO sensor can no longer be calibrated or shows an elevated reading that cannot be brought to zero with a zero calibration, the CO sensor should be replaced.

#### **WARNING!**

Extremely high levels of VOCs will send the CO sensor into alarm and the sensor may not recover or the recovery period will be significant. Take the impact on sensor performance into account when installing sensors.

**Failure to follow these warnings can result in serious personal injury or death.**

If the gas concentration reaches or exceeds the alarm set point or the STEL or TWA limits, the:

- alarm message displays and flashes in combination with the corresponding gas concentration
- backlight turns on
- alarm sounds (if active)
- alarm LEDs flash (if active)
- vibrating alarm triggers (if active)

#### 4.8 Monitoring Oxygen Concentration

The device monitors the oxygen concentration in ambient air. The alarm set points can be set to activate on two different conditions:

- Enriched - oxygen concentration  $> 20.8\%$  or
- Deficient - oxygen concentration  $< 19.5\%$ .

While the device can detect up to 30% oxygen in the ambient air, it is approved for use only up to 21% oxygen-content.

#### **WARNING!**

If an alarm activates while using the device, leave the area immediately.

**Failure to follow this warning can result in serious personal injury or death.**

## 4 Description

---

When the alarm set point is reached for either of the above conditions:

- the alarm message displays and flashes in combination with the corresponding gas concentration
- backlight turns on
- alarm sounds (if active)
- alarm LEDs flash (if active)
- vibrating alarm triggers (if active)

The LOW alarm (oxygen deficient) is latching and will not automatically reset when the O<sub>2</sub> concentration rises above the LOW set point. To reset the alarm press the ▲ button. If the alarm is latching, the ▲ button silences the alarm for five seconds. Alarms can be made latching or unlatching via MSA Link software.

False oxygen alarms can occur due to changes in barometric pressure (altitude), humidity or extreme changes in ambient temperature.

It is recommended that an oxygen calibration be performed at the temperature and pressure of use. Be sure that the device is in known fresh air before performing a calibration.

### 4.9 Monitoring Combustible Gases

The device can be equipped with a catalytic combustible sensor that detects a variety of combustible gases up to 100% LEL and displays the reading as either % LEL or % CH<sub>4</sub>.

#### **WARNING!**

If an alarm is triggered while using the device, leave the area immediately.

**Failure to follow this warning can result in serious personal injury or death.**

---

The catalytic combustible sensor has two alarm setpoints:

- HIGH Alarm
- LOW Alarm

If the gas concentration reaches or exceeds the alarm set point, the device:

- alarm message displays and flashes in combination with the corresponding gas concentration:
- backlight turns on
- alarm sounds (if active)
- alarm LEDs flash (if active)

#### **Gas Exposure of 100% LEL**

When gas reading exceeds 100% of the lower explosive limit (LEL), the catalytic combustible sensor enters a Lock Alarm state and displays "XXX" in place of the actual reading.

#### **WARNING!**

A catalytic combustible gas reading of "XXX" indicates the atmosphere could be above 100% LEL or 5.00 % Vol CH<sub>4</sub> and an explosion hazard exists. Move away from contaminated area immediately.

**Failure to follow this warning can result in serious personal injury or death.**

---

The user can clear the LockAlarm state only by turning the device OFF, and then ON again in a fresh air environment. When catalytic combustible gas reading digits appear, the device is available again for measuring gases.



Check national standard values for 100% LEL.

---



#### 4.10 Monitoring VOC Gases

The device is equipped with a PID sensor that detects a variety of VOC gases. The device displays the gas concentration in parts per million (ppm),  $\mu\text{mol/mol}$  or  $\text{mg/m}^3$  on the Measuring page.

#### **WARNING!**

If an alarm is triggered while using the device, leave the area immediately.

**Failure to follow this warning can result in serious personal injury or death.**

The device has four gas alarms:

- HIGH Alarm
- LOW Alarm
- STEL Alarm
- TWA Alarm

If the gas concentration reaches or exceeds the alarm set point or the STEL or TWA limits, the:

- alarm message displays and flashes in combination with the corresponding gas concentration
- backlight turns on
- alarm sounds (if active)
- alarm LEDs flash (if active)
- vibrating alarm triggers (if active)

To reset the alarm press the ▲ button.

False VOC alarms can occur due to changes in barometric pressure (altitude), humidity or extreme changes in ambient temperature.

It is recommended that a VOC calibration be performed at the temperature, humidity and pressure of use.

Be sure that the device is in known fresh air before performing a calibration. For optimal lamp strike, the PID lamp should be started within the normal temperature range.



When the device is calibrated in an dry, air conditioned environment and taken to a high temperature and high humidity outdoor environment, a VOC Low or High alarm may be triggered by this sudden change. It is recommended that the PID sensors be cleaned prior to this transition to avoid this situation, or to acclimate the sensor to the outdoor conditions in a known safe area.

#### 4.11 Displaying Current Response Factor

The current Response Factor (RF) is displayed at device startup along with the PID lamp potential in eV value, sensor range and VOC gas type.

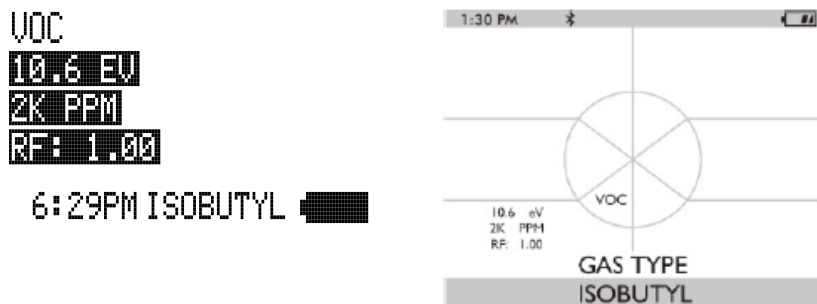

Figure 10

## 5 Operation

During operations, the RF can be displayed through several menus. If the Menu Enable option is On, use the ▼ button on the Main Measuring page to scroll through the menu options and select YES on "Change VOC Gas?". Selecting any gas on this page will display the 8 character gas name, the Response Factor, the Maximum Value of the VOC gas and the current High and Low Alarm values.

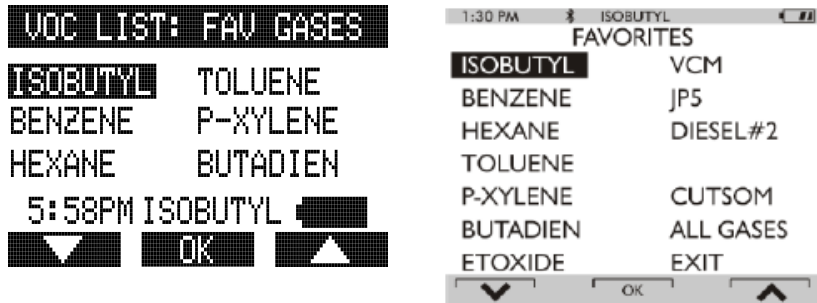

Figure 11

The Maximum Value is calculated by multiplying the sensor range by the RF. For example, the Max Value for Hexane is  $2000 * 4.5 = 9000$  ppm. The maximum value cannot exceed 9999 ppm .



It is the responsibility of the user to change the VOC Low and High Alarms as appropriate for the applied RF. The selection of the alarm limits must be under the direction of a qualified safety professional who has carefully evaluated the specific hazards of the jobsite where it will be used and who is completely familiar with the product and its limitations.

A complete list of the 8 character gas name and Response Factors for all VOC gases is contained in [10 PID Response Factor Table](#)

### 4.12 Calibration Certification

All applicable inspections, testing, and calibrations were performed using NIST traceable equipment, where available, in accordance with MSA's ISO 9001 Certified Quality System. Each material, component, and/or instrument must be installed, operated and maintained in strict accordance with its labels, cautions, warnings, instructions, and within the limitations stated in the supplied instruction manual. Routine calibration checks, equipment inspections, and applicable preventative maintenance measures must be performed to verify that the materials, components, and/or instruments are operating properly. Failure to perform these tasks on a routine basis, or suggested intervals, with specified equipment or methods, may result in inaccurate readings.

## 5 Operation

Device operation is dialog driven from the display with the aid of the three function buttons ( [Figure 2](#) ).

For more information, see the flow charts in [11.1 Basic Operation](#).

### 5.1 Environmental Factors

A number of environmental factors may affect the gas sensor readings, including changes in pressure, humidity and temperature. Pressure and humidity changes affect the amount of oxygen actually present in the atmosphere.

#### Pressure Changes

If pressure changes rapidly (e.g., stepping through airlock), the oxygen sensor reading may temporarily shift and possibly cause the device to go into alarm. While the percentage of oxygen may remain at or near 20.8 Vol %, the total amount of oxygen present in the atmosphere available for respiration may become a hazard if the overall pressure is reduced by a significant degree.

#### Humidity Changes

If humidity changes by any significant degree (e.g., going from a dry, air conditioned environment to outdoor, moisture laden air), oxygen readings can be reduced by up to 0.5 %, due to water vapor in the air displacing oxygen.

The oxygen sensor has a special filter to reduce the effects of humidity changes on oxygen readings. This effect will not be noticed immediately, but slowly impacts oxygen readings over several hours.

### Temperature Changes

The sensors have built-in temperature compensation. However, if temperature shifts dramatically, the sensor reading could shift.

### Combined Humidity and Temperature Changes

When the device is calibrated in a dry, air conditioned environment and taken to a high temperature and high humidity outdoor environment, a VOC Low or High alarm may be triggered by this sudden change. It is recommended that the PID sensors be cleaned prior to this transition to avoid this situation, or to acclimate the sensor to the outdoor conditions in a known safe area.

## 5.2 Turning ON and Fresh Air Setup

Device operation is dialog driven from the display with the aid of the three function buttons (→ [Figure 1](#)).

For more information, see the flow charts in [11.1 Basic Operation](#).

Turn the device ON with the  button.

The device performs a self test:

During the self test, the device checks alarm LEDs, audible alarm, vibrating alarm and installed sensors.

The device displays:

- Startup logo
- Software version, device serial number, company name, department and user names
- IC / FCC ID Identifier
- Sampling system safety test

During the turn-ON sequence, if a sensor was changed since the previous device operation, the current listing of the installed sensors displays and user interaction is required.

*The user must accept the new configuration by pressing the  button.*

*If the current sensor configuration is not accepted, the device alarms and is not usable.*

- FCC Identification page
- Combustible gas type, and installed sensor indication
- VOC gas type, lamp value, detectable range and Response Factor
- Alarm setpoints Low Alarm
- Alarm setpoints High Alarm
- Alarm setpoints STEL Alarm (if enabled)
- Alarm setpoints TWA Alarm (if enabled)
- Settings for calibration cylinder
- Current date
- Last calibration date (if enabled)
- CAL due date. If the calibration due date is enabled, the message "**CAL DUE; X DAYS**" appears on the device display.
  - X = the number of days until a calibration is due, user selectable for 1 to 180 days.

If the number of days until calibration is due reaches 0, an alert occurs and "**CAL DUE, NOW**" displays.

- Press the  button to clear the alert

- Sensor warm-up period
- Fresh Air Setup option (if enabled).

The Main Measure Page will appear.

The presence of a ♥ indicator on the display means a sensor is approaching or has reached its end-of-life. See [4.3 Alarms](#) for details on the Sensor Life Alarm situation.

Refer to flowchart in chapter [11.1 Basic Operation](#).

### Sampling System Safety Test

Upon startup, an alarm (visual, audible and vibrating) is triggered and the customer is prompted to block the pumps/sampling system of the device within 30 seconds.

When the device detects a pump flow block, it will display a PASS message. The startup sequence will resume.

If the device does not detect a pump flow block, it will display an error message.

The device will shut OFF after the customer acknowledges this message by pressing the ▲ button.

Check the sampling system if this occurs and contact MSA as needed.

Users can check the operation of the sampling system any time during operation by blocking the sampling system to generate a pump alarm.

#### **WARNING!**

Do not use the pump, sample line, or probe unless the pump alarm activates when the flow is blocked. Lack of an alarm is an indication that a sample may not be drawn to the sensors, which could cause inaccurate readings.

**Failure to follow this warning can result in serious personal injury or death.**

---

Never let the end of the sampling line touch or go under any liquid surface. If liquid is drawn into the device, readings will be inaccurate and device could be damaged. MSA recommends the use of an MSA sample probe containing a special membrane filter, permeable to gas but impermeable to water, to prevent such an occurrence.

### 5.2.1 Fresh Air Setup (FAS) at device Turn-ON

The **Fresh Air Setup (FAS)** is for automatic ZERO adjustment of the device.

The FAS has limits. If a hazardous level of gas is present, the device ignores the FAS command and the device alarm activates.

The ability to perform an FAS at device turn-ON can be disabled by using MSA Link software.

#### **WARNING!**

Do not perform the Fresh Air Setup unless you are certain you are in fresh, uncontaminated air; otherwise, inaccurate readings can occur which can falsely indicate that a hazardous atmosphere is safe. If you have any doubts as to the quality of the surrounding air, do not use the Fresh Air Setup feature. Do not use the Fresh Air Setup as a substitute for daily calibration checks. The calibration check is required to verify span accuracy.

**Failure to follow this warning can result in serious personal injury or death.**

---

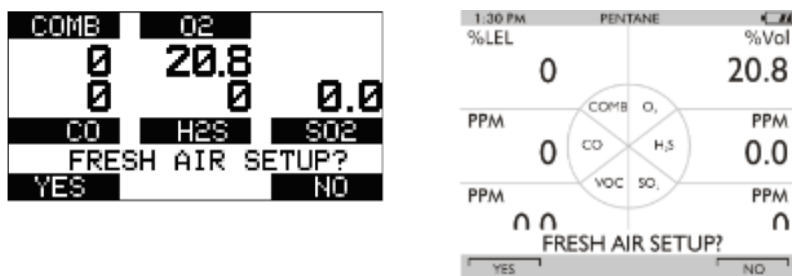

Figure 12 Fresh Air Setup

The device displays a blinking "FRESH AIR SETUP?", prompting the user to perform a Fresh Air Setup:

1. Press the ▲ button to bypass the Fresh Air Setup.

*The Fresh Air Setup is skipped and the device goes to the Measuring page (Main page).*

2. Press the ▼ button to perform the Fresh Air Setup.

*The device starts the FAS sequence and the FAS screen displays.*

*A progress bar shows the user how much of the FAS has been completed.*

*At the end of the FAS, the device displays either "FRESH AIR SETUP PASS" or "FRESH AIR SETUP FAIL".*

If the FAS fails, perform a zero calibration (→ [5.10 Calibration](#)).

### 5.3 Special Consideration for Oxygen Sensor

Under the following situations, the oxygen sensor display reading may be suppressed for up to 30 minutes at device turn-ON as a sensor 'cook down' is performed.

This could occur if:

- the oxygen sensor was just installed
- the battery pack was allowed to be deep-discharged
- the battery pack was removed from the device.

During this time, the oxygen sensor numeric position on the display indicates "PLEASE WAIT". While this message displays, the device cannot respond to a:







- Fresh Air Setup
- Calibration
- Bump Test procedure.

When the numeric oxygen reading appears, the FAS, calibration, or Bump Test procedures may be performed.

## 5 Operation

### 5.4 Measurement Mode [Normal Operation]

The following options pages can be executed from the Measurement screen:

<b>BUMP page</b>		This page allows user to perform a Bump Test on installed sensors
<b>Peak Page*</b>		This page shows the peak readings for all sensors.
<b>Min Page</b>		This page shows the minimum readings for the oxygen sensor.
<b>STEL Page*</b>		This page shows the calculated STEL readings of the device.
<b>TWA Page*</b>		This page shows the calculated TWA readings of the device.
<b>Date Page</b>		This page shows actual date settings of the device.
<b>Last Cal Date</b>		This page shows the date of the last calibration.
<b>Cal Due*</b>		This page shows the set date for the next calibration.
<b>Change VOC Gas?</b>		This page allows the VOC gas type to be changed
<b>Discoverable Mode</b>		This page allows the user to put the device into Bluetooth discoverable mode in order to pair with another device.
<b>Motion Alert</b>		This page allows the Motion Alert Feature to be activated or deactivated.

\* The display of these pages can be de-activated through MSA Link software

For further information see [12 Changeable Feature Summary](#).

### 5.5 Device Setup

The device has provisions to access and modify the following parameters through direct button interface:

- Calibration Options
- Alarm Options
- Instrument Options

These menus can be accessed only from the measure page by pressing and holding the ▼ and ▲ buttons simultaneously until prompted for a password.

The operation is as follows:

1. Turn the device ON and wait until the measure page appears.
2. Simultaneously press and hold the ▼ and ▲ buttons for approximately five seconds.
  - a. The default password is "672".

#### PASSWORD



000

3. Enter the first digit by pressing the ▼ or ▲ button and confirm with the  button.

*The cursor jumps to the second digit.*

4. Enter the second as well as the third digits.

*Incorrect password: device returns to the Main Page.*

*Correct password: user can enter the Setup mode.*

The password can be changed with a PC through the MSA Link software. If the password is forgotten, it can be reset by using MSA Link software. Contact MSA Customer Service for assistance. The following Options are available by pressing the ▼ and ▲ buttons:

- Calibration Options - [5.5.1 Calibration Setup](#)
- Alarm Options - [5.5.2 Alarm Setup](#)
- Instrument Options - [11.8 Instrument Options](#)

### 5.5.1 Calibration Setup

#### CALIBRATION OPTIONS



The Calibration Options menu has provisions to:

- modify the calibration cylinder settings (CYLINDER SETUP)
- enable/disable calibration due and to set the number of days (CAL DUE OPTIONS)
- enable/disable the option to show the last cal date at turn on and (LAST CAL DATE)

When enabled, the date of the last device calibration displays during the turn-ON process.

- enable/disable the option for password protected calibration (CAL PASSWORD)

When enabled, the device setup password must be entered prior to calibration.

Press:

- the ▼ button go to next page
- the ▲ button to go previous page
- the ⏏ button to enter setup.

#### Setting Calibration Cylinder

This option has a dialog similar to the span calibration dialog.

The display shows all active sensors.

1. Press the ⏏ button to enter setup.

*The screen for the first calibration cylinder displays.*

2. Press

the ▼ or ▲ button to change the value.

the ⏏ button to confirm the setup.

With this confirmation the device automatically moves to the next cylinder setting.

3. Repeat the sequence for changing the required settings for all necessary gas values.





After the last setting is performed, the device returns to the Calibration Options menu.





The only allowed calibration gas for the 0-2000 ppm PID sensor is 100 ppm isobutylene balanced in air. Higher concentrations can cause false readings of the CO sensor.

#### Setting Cal Due Options



1. Press the ⏏ button to enter setup.
2. Press the ▼ or ▲ button to enable/disable this option.

3. Press the  button to confirm.
4. After confirmation the device prompts the user to enter the number of days for the reminder.
5. Change number of days by pressing the  or  button.
6. Press the  button to go to the next menu.



### Setting Last Cal Date

1. Press the  button to enable/disable this option.
2. Press the  button to go to the next page.
3. Press the  button to go to the previous page.

### Setting Calibration Password

1. Press the  button to enable/disable this option.
2. Press the  button to go to the next page.
3. Press the  button to go to the previous page.

### Back To Main Menu

1. Press the  button to go to Device Setup Menu  
*The Cal Options screen displays*
2. Press the  button to go to the next (Alarm options) or the  button to exit the Setup menu.

## 5.5.2 Alarm Setup

### ALARM OPTIONS





The Alarm Options Menu allows the user to:

- enable/disable the vibrating alarm
- enable/disable the audible alarm (horn)
- enable/disable the Alarm LEDs
- enable/disable the MOTIONALERT SELECTION page.

If disabled, the user cannot change the device MotionAlert setting.

- set Sensor Alarms.

Press

- the  button go to next page
- the  button to go previous page
- the  button to enter setup.

### Setting Vibrating Alarm

Press the  button to enable/disable this option.

### Setting Horn Alarm

Press  button to enable/disable this option.



## Setting LED Alarm

Press  button to enable/disable this option.

## Setting MotionAlert Access

Setting this parameter allows the user to access the MOTIONALERT page from the MEASURE page.

If access is denied here:

- the user cannot access the MOTIONALERT page to enable or disable that feature
  - the InstantAlert feature ([4.3 Alarms](#)) cannot be activated.
1. To grant or deny user access to the MOTIONALERT page, use the button to change the indicated selection.

User access is:

*permitted when the setting indicates ON.*

*denied when the setting indicates OFF.*

2. The selection is confirmed by pressing either the ▼ or ▲ button.

## Setting Sensor Alarms

This page allows modifying the preset alarm values of:

- LOW Alarm
- HIGH Alarm
- STEL Alarm
- TWA Alarm.



Factory set alarm levels are shown in [7.1 Factory-Set Alarm Thresholds and Setpoints](#).

1. Press the  button to enter Sensor Alarm setup.

*LOW Alarm Setup screen displays.*

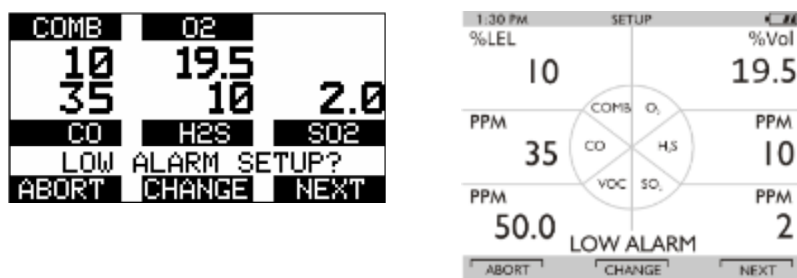



Figure 13 Sensor Alarm Setup

2. Press
  - the ▼ button to abort the operation or
  - the ▲ button to go to next alarm setup or
  - the  button to change the alarm setpoints.

*Alarm Value for the first Sensor displays.*



Figure 14 Sensor Alarm Setup

3. Set values for Sensor Alarm by pressing the ▼ or ▲ button.
4. Press the ⏵ button to confirm set value.
5. Repeat setting for all other sensors.
6. Press the ▲ button to return to the Alarm Options menu.
7. Repeat setting for all other alarm types.

### 5.5.3 Instrument Options

#### SETTINGS



The Instrument Options menu allows modification of different device options:

- Sensor Setup (enable/disable the channel)
- Language Setup
- Time Date Setup
- Datalog Intervals
- Stealth Mode
- Operating Beep
- Backlight Options
- VOC Gas Setup
- Bluetooth

Press

- the ▼ button go to next page
- the ▲ button to go previous page
- the ⏵ button to enter setup.

#### Setting Sensor Options

1. Press the ⏵ button to enter setup.

*Following screen displays:*

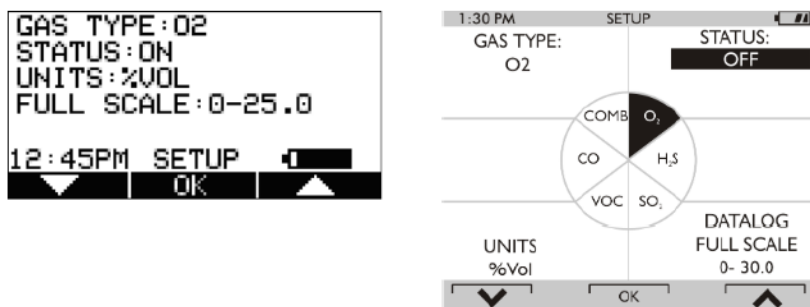

Figure 15 Sensor Options Setup

2. Press the ▼ button to select sensor, press the ⏵ button to make changes.

*The sensor information is displayed and the sensor can be enabled or disabled.*



Other operations such as changing the combustible gas type (Methane, Butane, Propane etc.) and units (ppm to mg/m<sup>3</sup>) are only possible using the MSA Link software.

3. Change status by pressing the ▼ or ▲ button.
4. Press the ⏵ button to confirm and advance to next screen (next sensor).
5. Perform the sequence for all other sensors.

*After setting up the last sensor the device goes to the next Setup Page.*

### Language Setup

This option is for setting the language of the device.

1. Press the ⏵ button to enter setup.
2. Change language by pressing the ▼ or ▲ button.
3. Confirm with the ⏵ button.

*The device goes to the next Setup Page.*

### Time and Date Setup

This option is for setting the device time and date. The device first prompts to set the time and then it prompts for the date.



The time can be set up for either regular AM/PM or military time (through MSA Link software). AM/PM time is the default setting.

1. Press the ⏵ button to enter setup.
2. Change hours by pressing the ▼ or ▲ button.
3. Confirm with the ⏵ button.
4. Change minutes by pressing the ▼ or ▲ button.
5. Confirm with the ⏵ button.

*The device goes to the Set Date Page.*

6. Change month, date and year by pressing the ▼ or ▲ button and confirming with the ⏵ button.



*The device goes to the next Setup Page.*

7. Confirm with the ⏵ button.

*The device goes to the next Setup Page.*





### Setting Stealth Mode

Stealth mode disables the visual, audible and vibrating alarms.

1. Press the  button to change mode (ON/OFF).
2. Press the  button to go to the next page or the  button to return to previous page.



### Setting Datalog Intervals

This option is for setting the intervals at which all the readings will be logged.







1. Press the  button to enter setup.
2. Change interval by pressing the  or  button.
3. Confirm with the  button.

*The device goes to the next Setup Page.*

### Setting Operating Beep

1. Press the  button to change mode (ON/OFF).
2. Press the  button to go to the next page or the  button to return to previous page.

### Setting Backlight

1. Press the  button to enter setup.  
*Change option by pressing the  or  button.*
2. Press the  button to enter.
3. Change timeout by pressing the  or  button.
4. Press  button to confirm timeout.

### PID Setup

#### **WARNING!**

It is very important to have an understanding of PID basics when changing PID settings. Failure to properly identify the VOC gas being measured and/or failures to select the correct Response Factor alarm values (exposure, STEL, TWA) that match the desired Response Factor and/or the correct lamp will result in erroneous readings or erroneous alarm limits that could cause death or serious personal injury.

The PID sensor should be configured prior to initial operation.

1. Enter the correct password enter the 'Instrument Setup' menu and press the  button until VOC Gas Setup is highlighted, then select OK.

There are five configuration pages available:

Configuration page	
Menu Enable	Menu Enable On allows the VOC gas to be changed without entering the password. When Menu Enable On is active, the "Change VOC Gas?" option is available from the Main Measuring Page as described in <a href="#">4.4 On-Screen Indicators</a> . The default setting is ON.
Maintain VOC Gas	Maintain VOC Gas ON retains the currently selected VOC gas when the device is powered down and restarted. If this option is set to OFF the device will always power up with isobutylene selected as the VOC gas type. This option should be set to ON if the same VOC gas is to be monitored on every use. The default setting is ON.
Favorites Setup	This set of pages allows the default Favorites list to be changed with VOC gases suitable for the user's particular environment. The ten default Favorites will be displayed on initial use. The first screen in the Favorites Setup page will ask which Favorite is to be replaced.



<b>Configuration page</b>	<ol style="list-style-type: none"> <li>1. Select the gas to be replaced by using the ▼ or ▲ button to highlight then select OK. <i>The next screen will display the current 10 Favorites, and options for Custom Gas and All Gases.</i></li> <li>2. Highlight the gas to add to the Favorites and select OK. <i>A Confirmation Screen will be displayed showing the gas to be replaced and the gas to be added to Favorites.</i> <i>Selecting YES will return to the Favorites list showing the new gas, selecting NO will return to the Favorites list showing the previous Favorites and selecting ABORT will return to the menu page.</i></li> </ol>
VOC Gas Selection	<p>This menu displays all of the gases available for detection by this PID sensor type. The gases are listed by an 8 character abbreviation. The full gas names are listed in <a href="#">10 PID Response Factor Table</a> of this manual. The first 10 gases listed are the Favorites gases followed by options for the All Gas List and the Custom List. Gas names starting with the letters A-Z are listed alphabetically. Each page contains 14 gas names.</p> <ol style="list-style-type: none"> <li>1. Select the gas of interest by using the ▼ or ▲ button to highlight then select OK.</li> </ol> <p>Holding down the ▼ or ▲ button for more than 2 seconds will scroll a full page at a time.</p> <p>Selecting OK will display a confirmation page that contains the following information:</p> <ul style="list-style-type: none"> <li>• 8 character short name</li> <li>• Response Factor (RF) for the selected gas</li> <li>• Maximum Value of that gas (Full scale sensor value x RF). The Maximum Value is calculated by multiplying the sensor range by the RF. For example, the Max Value for Hexane is <math>2000 * 4.5 = 9000\text{ppm}</math>. The maximum value cannot exceed 9999ppm due to display resolution limitations.</li> <li>• High Alarm - this reflects the current High Alarm value. Change if necessary for the chosen Response Factor</li> <li>• Low Alarm - this reflects the current High Alarm value. Change if necessary for the chosen Response Factor</li> </ul>
Custom Gas Setup	<p>The Custom Gas Setup allows a unique 8 character gas name and associated Response Factor to be entered for up to 10 Custom gases.</p> <ol style="list-style-type: none"> <li>1. Select which Custom Gas (1 - 10) to enter or replace. <ol style="list-style-type: none"> <li>a. Confirm with OK.</li> </ol> </li> <li>2. On the next screen, enter the 8 character gas name using the ▼ or ▲ buttons to select letters and numbers. <ol style="list-style-type: none"> <li>a. Select OK when the appropriate alpha-numeric characters are reached.</li> </ol> </li> <li>3. After the 8th character is entered, enter the Response Factor (0.1- 40.0). <i>Once the RF is complete, a final confirmation page will display.</i></li> <li>4. Select OK to apply the Custom Gas as the current gas or select NO and abort to the menu page.</li> </ol>

**⚠ WARNING!**

Failure to properly identify the VOC gas being measured and/or failures to select the correct alarm values (exposure, STEL, TWA) that match the desired Response Factor and/or the correct lamp will result in erroneous readings that could cause death or serious personal injury.



### Enabling Bluetooth

The device is configured with a Bluetooth capable communications feature.

1. Press the  button to enable or disable the Bluetooth communications device (ON/OFF).
2. Press the  button to return to the Main Menu or the  button to return to previous page.

### Back To Main Menu

There are three options at this point:

- the  button    Sensor Options menu
- the  button    Previous Setup page in the Instrument Options menu
- the  button    Instrument Options menu

### 5.6 Bluetooth Operation

**NOTE:** Versions of this product manufactured July 2022 and later may not contain Bluetooth wireless technology. This will be indicated by the front case of the detector not utilizing a Bluetooth logo. All references in this manual to Bluetooth will not pertain to these version of the device.

The Bluetooth communication device must be enabled for any Bluetooth functions to operate. See [5.5 Device Setup](#) Compatible Bluetooth host with appropriate software is required for proper operation.

#### Bluetooth Security

The Bluetooth connection is encrypted and secured with a unique six digit pin that must be double confirmed on both device and Bluetooth host at the time of pairing.

#### Discovery Mode



This device mode is used to enable a Bluetooth host to pair with the device for the first time or if a different Bluetooth host was connected with the device previously.



Note that the device will automatically enter discovery mode for five minutes at device turn on if Bluetooth has been enabled. Discovery mode will also be entered for 5 minutes following a disconnection.

---

To manually enter discovery mode:

1. Page down through the menu pages in Measurement Mode using the  button until the Discovery Mode page is displayed.
2. Press the  button to enter discovery mode.

*The blue led will blink rapidly indicating that the device is in Discovery Mode.*

#### Connecting the device to a Bluetooth host for the first time

1. Ensure that the device is on and in Discovery Mode
2. On the Bluetooth host, locate the Bluetooth device list. Select "A5X-xxxxxxx" from the list.

*Both the device and Bluetooth host will display a unique six digit security code to ensure that the correct devices are being paired.*

3. After confirming that the six digit codes match, confirm the pairing request on the device by pressing the  button.
4. Confirm on the Bluetooth host as well.

#### Connecting the Device to a Bluetooth Host

If this was the last device connected to the Bluetooth host, the Bluetooth host can connect to the device whether or not the device is in discovery mode as long as Bluetooth is enabled. The six digit code confirmation will not be displayed.



The device will only recall the last Bluetooth host it was paired with. If connecting to another Bluetooth host, the device must be placed into discovery mode to be detected.

### Pairing the device to a Bluetooth host

This device has an integrated RFID chip to facilitate a faster Bluetooth pairing process with a Bluetooth host that supports a RFID or NFC reader with appropriate software. Simply align the RFID or NFC reader of the Bluetooth host directly over the MSA logo on the front of the device. The device and Bluetooth host should become paired and connected.

### Disconnecting the Device from a Bluetooth Host

The device does not have a disconnect feature as this would be initiated by the Bluetooth host. Use the Bluetooth host functions to purposefully disconnect the device from the Bluetooth host.

### Device Configuration over Bluetooth Connection

The device has the ability to receive updates to device settings over the Bluetooth connection. The user must successfully pair the device and Bluetooth host confirming that the six digit security code matches both on the device and the Bluetooth host. After a configuration change has been initiated, the user must confirm the request on the device by pressing the ▼ button.

### Evacuation Alert over Bluetooth Connection

The device has the ability to receive an evacuate message over the Bluetooth connection. The user must successfully pair the device and Bluetooth host confirming that the six digit security code matches both on the device and the Bluetooth host. Once connected, an evacuate message sent to the device will send the device into alarm while displaying EVAC on the display. Press the ▲ button to silence the Evacuation alert and confirm the alert was received. Press the ▲ button a second time to reset the Evacuation alert once in a safe area.

## 5.7 MSA Link Operation

### Connecting device to PC

1. Switch ON the device and align the Datalink Communication port on the device to the IR interface of the PC.
2. Start the MSA Link software on the PC and start the connection by clicking the connect icon.

## 5.8 Function Tests on the Device

### Alarm Test

1. Turn ON the device.

The user should verify that:

- alarm LEDs flash
- horn sounds briefly
- vibrating alarm triggers briefly.

## 5.9 Bump Test



### WARNING!

- Perform a Bump Test before each day's use to verify proper device operation.
- For PID sensors manufactured from March 2020 to June 2023, a bump test or manual gas check must be performed each time that the unit is powered on.

**Failure to follow these warnings can result in serious personal injury or death.**



Bump test frequency is often stipulated by national or corporate regulations; however, more frequent bump tests is generally accepted as a best safety practice.

## 5 Operation

---

This test quickly confirms that the gas sensors are functioning. Perform a full calibration periodically to ensure accuracy and immediately if the device fails the Bump Test. The Bump Test can be performed using the procedure below or automatically using the GALAXY GX2 Test Stand.

CSA requires (per 22.2 NO. 152) that combustible sensor sensitivity be tested before each day's use on a known concentration of methane equivalent to 25 to 50 % of full scale concentration. ACCURACY MUST BE WITHIN 0 to +20 % OF ACTUAL. Correct accuracy by performing the calibration procedure described in [5.10 Calibration](#)

**NOTE:** The GALAXY GX2 cannot test the Chlorine Dioxide sensor. For this sensor, use this Bump Test procedure and/or manually calibrate as described in [5.10 Calibration](#).

### Equipment

See accessory chapter for ordering information for these components.

- Calibration Check Gas Cylinder(s)  
See [7.3 Calibration Specifications](#) for calibration gas target values and appropriate MSA calibration gas cylinders.
- Demand Flow Regulator(s)
- Tubing appropriate for the gases to be tested
- Kits containing tubing and regulators suitable for reactive and non-reactive gases are available from MSA.

### Performing a Bump Test

1. While the device is turned ON in a clean, fresh air environment, verify that readings indicate no gas is present.
2. From the normal measure screen press the ▼ button to display "BUMP TEST?".
3. Verify the gas concentrations displayed match the Calibration Check Gas Cylinder. If they do not, adjust the values through the Calibration Setup menu.

*Depending on the sensors installed, there could be one to five separate Bump Tests performed, each with a different cylinder, regulator, and tubing used.*

4. Attach the demand regulator (supplied in the calibration kit) to the cylinder providing the indicated gases.
5. Connect tubing (supplied in the calibration kit) to the regulator.
6. Attach the other end of tubing to the device pump inlet.
7. Press the  button to start the bump test:

*the progress bar advances*

*the sensors respond to the gas.*

The message BUMP TEST PASS indicates a successful Bump Test of the sensors.

If any sensor fails the Bump Test:

- the message BUMP TEST FAIL appears
- the failed sensor is indicated.

If there are more sensors to be Bump Tested, the next sensor displays and the process repeats from Step 4.

If there are no more sensors to be Bump Tested, the tubing can be removed from the device pump inlet.

### After the Bump Test

**NOTE:** Although the check mark will be visible after power cycling or turning on your unit (if bumped within 24 hours), a bump is still required after each time the device is turned on, for PID sensors manufactured between March 2020 and June 2023.

After all installed sensors pass the Bump Test, the ✓ symbol displays on the -MEASURE page. This ✓ symbol appears on the display in the upper feature bar

If any sensor was not bump tested, or fails the Bump Test, the ✓ symbol does not display.



The display:

- temporarily shows the  $\checkmark$  symbol at each gas reading for successfully bump tested sensors
- $\checkmark$  symbol is then replaced by the present gas reading.

The  $\checkmark$  symbol shows for 24 hours after the Bump Test.

If a sensor fails the Bump Test, calibrate the device as described in [5.10 Calibration](#)

## 5.10 Calibration

The ALTAIR 5X PID can be calibrated either manually using this procedure or automatically using the GALAXY GX2 test stand. Refer to [11.5 Calibration Options](#).

The use of the demand regulators listed in [9 Ordering Information](#) is recommended. If a new sensor has been installed, the battery pack has been depleted or a new battery pack has been installed allow sensors to stabilize for 30 minutes before calibration is performed.

### **⚠ WARNING!**

Special conditions with toxic gases!

If the device is to be checked or calibrated for reactive gases, prerequisites are required; otherwise, incorrect calibration would result in incorrect device operation.

Reactive toxic gases (e.g., chlorine, ammonia, chlorine dioxide) have the property of diffusing into the rubber and plastic tubes so that the volume of test gas available in the device would no longer be sufficient to correctly perform device calibration.

When calibrating the device with toxic gases, certain prerequisites are required, otherwise incorrect calibration could result:

- A special pressure regulator
- Shortest possible connection tubes between the pressure regulator and the device
- Connection tubes made from a material that does not absorb the test gases (e.g., PTFE).

**NOTE:** If using normal tubes and pressure regulators, expose them to the required test gas for an extended time period. Keep these materials dedicated for use with that test gas only; do not use them for other gases. For example, for chlorine, allow the entire contents of a test gas cylinder to flow through the pressure regulator and tubes before using to calibrate the device. Mark these materials for use with chlorine only.

### 5.10.1 Zero Calibration Procedure

1. Press the **▲** button for five seconds in Normal Measurement page.

*ZERO screen displays.*

To skip the ZERO procedure and move directly to the span calibration procedure, push the **▲** button. If no button is pushed for 30 seconds, the device prompts user to perform a SPAN calibration before device returns to the Normal Measurement page.

To perform **ONLY** a Fresh Air Setup at this time, press the **⏸** button. The device then performs a Fresh Air Setup as described in [5.2 Turning ON and Fresh Air Setup](#). When the Fresh Air Setup is complete, the device returns to the normal Measure screen.

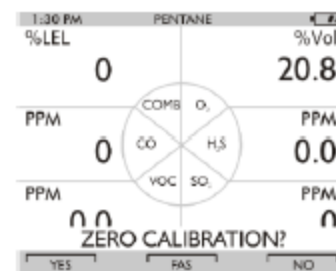
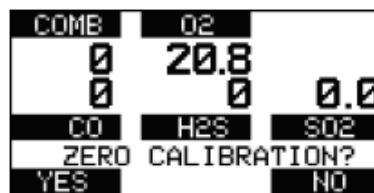

- Press the ▼ button to confirm the ZERO screen, i. e. to execute zero calibration.

The message "SENSOR REFRESH" displays, followed by the message "ZERO CALIBRATION".

The "REFRESH" message does not appear if a catalytic combustible sensor is not installed.

ZERO calibration starts.

A progress bar shows the user how much of the calibration has been completed.

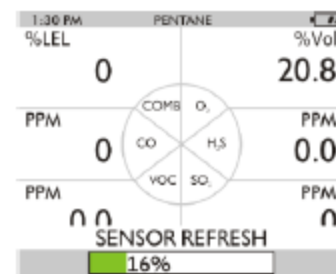
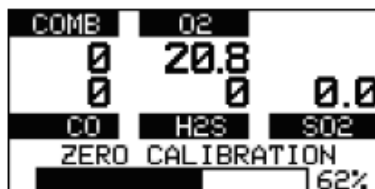

During the first moments of a ZERO calibration, the combustible sensor reading may be replaced by a moving display of "PLEASE WAIT". This is normal.

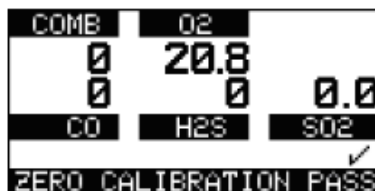

After the ZERO calibration is completed the device displays either

"ZERO CALIBRATION PASS"

or

"ZERO CALIBRATION FAIL".

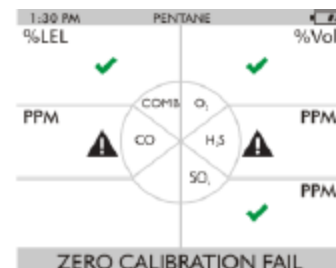
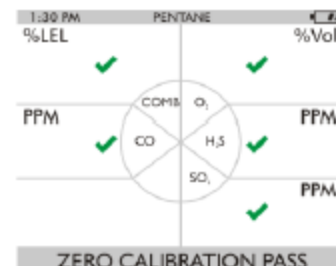
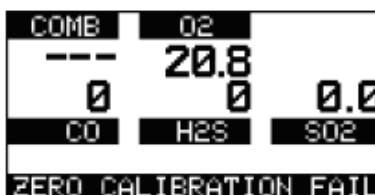

Only if the device passes the zero calibration the SPAN screen displays.

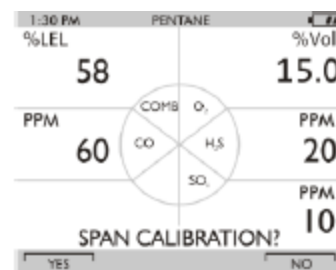

### 5.10.2 Span Calibration

To skip the Span calibration procedure, push the ▲ button.



If the SPAN calibration of the combustible sensor is skipped after a successful ZERO calibration, the combustible sensor reading may be replaced with a moving display of "PLEASE WAIT" for a few moments. This is normal, and the device is fully operational once a combustible gas reading reappears.

If no button is pushed for 30 seconds, span calibration is skipped.

Because of the different possible combinations of gases that are possible, skipping a Span calibration could advance the user to the Span calibration of another installed sensor, or back to Measuring mode.



When calibrating a 0-2000 ppm PID sensor, use 100 ppm isobutylene balanced in air. Isobutylene calibration gas other than 100 ppm is not allowed due to long term affect on the CO sensor.

1. Connect one end of tubing to the cylinder regulator (supplied in the calibration kit).
2. Connect the other end of the tubing to the pump inlet.
3. Press the ▼ button to calibrate (span) the device.

“SPAN CALIBRATION“ flashes

SPAN calibration starts.

A progress bar shows the user how much of the calibration has already been completed.

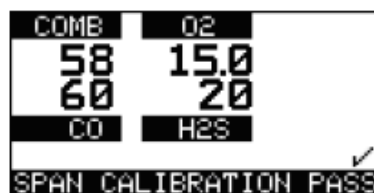
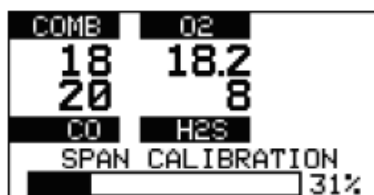
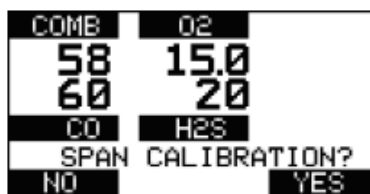

After the SPAN calibration is completed, the device displays either

“SPAN CALIBRATION PASS”

or

“SPAN CALIBRATION FAIL”

The device returns to Measuring mode.

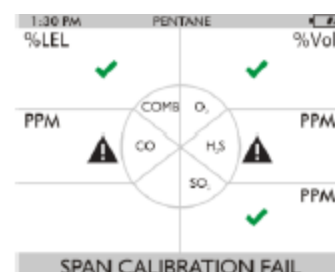
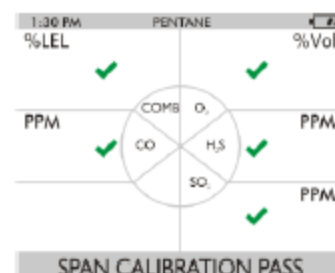
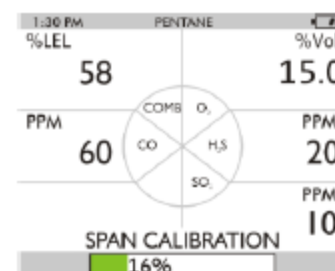
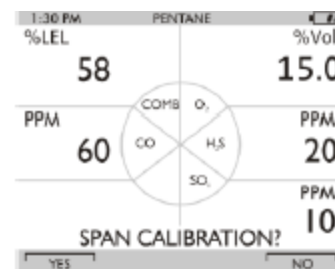
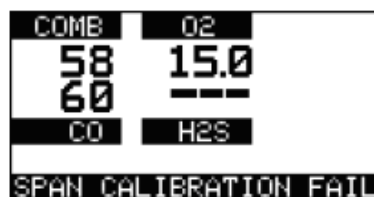

If a sensor is nearing its end-of-life, the "PASS" display is followed by the Sensor Life indicator ♥ display.

- While the sensor is still fully functional, this warning gives the user time to plan for a replacement sensor to minimize downtime.
- The ♥ indicator blinks as the device returns to Measure mode.
- After 15 seconds, the blinking stops, but the ♥ indicator continues to display during ongoing operations as a reminder of a sensor's pending end-of-life.

If a span calibration fails:

- The Sensor Life Indicator ♥ blinks to show a sensor has reached its end-of-life and should be replaced.
- The device remains in the Sensor Life alarm condition until the ▲ button is pressed.
- After the alarm is cleared, the device enters Measure mode and the Sensor Life indicator ♥ blinks during ongoing operations until the sensor is replaced and/or successfully calibrated.

## 5 Operation

---

Span calibration can fail for reasons other than a sensor at the end of its life. If a span calibration failure occurs, verify items such as:

- sufficient gas remaining in the calibration cylinder
- gas expiration date
- integrity of calibration tubing/fittings, etc.

Reattempt the span calibration before replacing the sensor.

### 5.10.3 Finishing Successful Calibration

1. Remove the calibration tube from pump inlet.

The calibration procedure adjusts the span value for any sensor that passes the calibration test. Sensors that fail calibration are left unchanged.

On the display, each successfully calibrated sensor temporarily shows a √ symbol at its gas reading.

These √ symbols remain visible for a few moments and are then replaced by the present gas reading.

Since residual gas may be present, the device may briefly go into an exposure alarm after the calibration sequence is completed.

2. Press the ▲ button to reset the alarm as necessary.

Following a PID sensor calibration, VOC gas readings may be slightly elevated (< 5 ppm) for several minutes. This is normal behavior as the isobutylene is purged from the device.

A √ symbol displays on the MEASURE page. This √ symbol appears on the display in the upper feature bar.

The √ symbol displays for 24 hours after the calibration and then turns off.



If the horn alarm is turned OFF, the calibration √ symbol does not appear on the display.

---

### Calibration with an Automated Test System

The device can be calibrated using the GALAXY GX2 Automated Test System - contact MSA for a list of compatible gases and concentrations.

Similar to the successful (manual) calibration described in [5.10.3 Finishing Successful Calibration](#), a √ symbol displays on the MEASURE page after successful GALAXY GX2 calibration.

This √ symbol appears on the display in the upper feature bar.

The √ symbol displays for 24 hours after the calibration and then turns off.



If the horn alarm is turned OFF, the calibration √ symbol does not appear on the display.

---

### 5.11 Time of Day Testing

This feature permits the device to be automatically calibrated on a user-defined interval. The most common use of this feature allows the user to configure the ALTAIR 5X PID and the GALAXY GX2 System to automatically calibrate a device prior to the start of work-shift. See the GALAXY GX2 Operating Manual ("Automated Testing Features" section) for a complete description of how to configure the GALAXY GX2 for this mode.

On ALTAIR 5X PID devices, the following settings must be configured using either MSA Link or the GALAXY GX2 → Instrument Setup page:

- For automated calibration testing, Calibration Due must be enabled and a non-zero Calibration Interval must be entered for automatic calibration testing
- For automated bump testing, Bump Due must be enabled and a non-zero Bump Interval must be entered for automatic bump testing

Carefully follow all GALAXY GX2 set-up directions as described in the GALAXY GX2 Operating Manual for proper setup.

## 5.12 Device Shutdown

For device shutdown press and hold the  button.

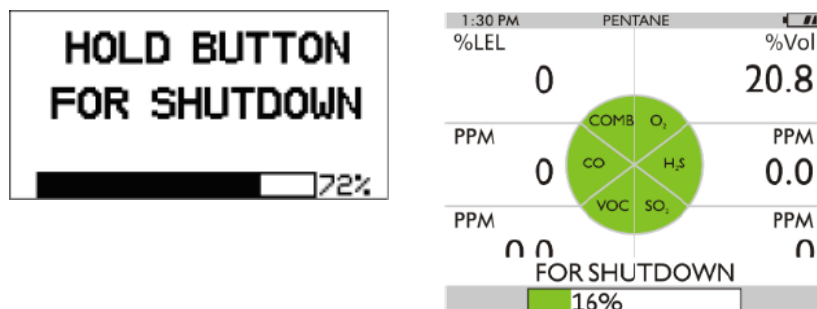

Figure 16 Shutdown

The device displays a blinking "HOLD BUTTON FOR SHUTDOWN" and a progress bar shows the user how much longer to hold the button to complete the shutdown.

## 5.13 Manual Gas Check

To verify proper device operation, PID sensors manufactured from March 2020 to June 2023 must have a bump test or manual gas check performed each time that the unit is powered on, prior to use. This requirement is in addition to existing usage guidelines.

To reduce the number of bump tests required during daily usage, leave the Altair device operating continuously in between uses. Manual gas checks may be performed as a substitute for the bump test if it is not convenient to perform a bump test, for example if a GALAXY GX2 Automated Test System is not nearby.

### Equipment

**NOTE:** See [9.3 Accessories](#) for ordering information for these components:

1. 100 ppm Isobutylene cylinder
2. Demand flow regulator
3. Calibration tubing

### Performing the Gas Check

**NOTE:** Use 100ppm Isobutylene balanced in air.

1. While the device is turned ON in a clean, fresh air environment, verify that readings indicate no gas is present.
2. Attach the demand regulator to the isobutylene cylinder.
3. Connect the tubing to the regulator.
4. Attach the other end of the tubing to the device pump inlet.
5. Allow the unit to run for 30 seconds.
6. Observe the reading on device display
  - a. If a response is observed, the PID sensor has passed the gas check. Disconnect cylinder and begin normal operation
  - b. If no response is observed, calibrate the device as described in [5.10 Calibration](#).

## 6 Maintenance

If irregularities occur during operation, use the displayed error codes and messages to determine appropriate next steps.

### WARNING!



Repair or alteration of the device beyond the procedures described in this manual by anyone other than a person authorized by MSA, could cause the unit to fail to perform properly. Use only genuine MSA replacement parts when performing any maintenance procedures described in this manual. Substitution or incorrect installation of components can seriously impair performance of the unit, alter intrinsic safety characteristics or void agency approvals.

**Failure to follow this warning can result in serious personal injury or death.**



Refer to EN 60079-29-2 (Guide for the selection, installation, use and maintenance of apparatus for the detection and measurement of combustible gases or oxygen) and EN 45544-4 (Guide for the selection, installation, use and maintenance of electrical apparatus used for the direct detection and direct concentration measurement of toxic gases and vapors).

### 6.1 Troubleshooting

Error State	Details	Recommended Action
<b>Alternating display</b>		
ADC ERROR	Analogue measurement error	Contact MSA
MEM ERROR	Memory error	Contact MSA
PROG ERROR	Program error	Contact MSA
RAM ERROR	RAM error	Contact MSA
BT ERROR	Bluetooth error	Contact MSA
LOW BATTERY  (flashing)	Battery Warning repeats every 30 seconds	Remove from service as soon as possible and recharge or replace battery
BATTERY ALARM	Battery is completely discharged	Device is no longer sensing gas; Remove from service and recharge or replace battery.
Device does not turn ON	Battery fully discharged	Remove from service as soon as possible and - recharge or replace battery pack.
SENSOR MISSING	Sensor damaged or missing	Replace sensor
NO SENSORS	No sensors are enabled	Device must have at least one sensor enabled at all times
	Sensor warning	Sensor is near the end of its life
 (flashing)	Sensor alarm	Sensor has reached the end of its life and cannot be calibrated. Replace sensor and recalibrate.
PUMP ERROR	Pump malfunction or flow path blockage	Check flowpath for blockage. If error persists, remove from service.
INVALID CONFIGURATION	Sensor(s) installed in incorrect location.	Install sensors as shown in <a href="#">Figure 18</a> .

## 6.2 Verifying Pump Operation

Users can check operation of the sampling system any time during operation by blocking the sampling system to generate a pump alarm.

When the pump inlet, sample line or probe is blocked, the pump alarm must activate.

Once gas readings are displayed, plug the free end of the sampling line or probe.

- The pump motor shuts down and an alarm sounds.
  - PUMP ERROR will flash on the display.
1. Press the ▲ button to reset the alarm and restart the pump.

If the alarm does not activate:

- Check the sample line and probe for leaks.
  - Once leak is fixed, recheck pump alarm by blocking the flow.
2. Press the ▲ button to reset the alarm and restart the pump.

### **WARNING!**

Do not use the device, sample line, or probe unless the pump alarm activates when the flow is blocked. Lack of an alarm is an indication that a sample may not be drawn to the sensors, which could cause inaccurate readings. If a sample line or probe is installed and the pump alarm does not activate, remove the line or probe and repeat the test. This will provide information on where the blockage is located.

**Failure to follow this warning can result in serious personal injury or death.**

---

Never let the end of the sampling line touch or go under any liquid surface. If liquid is drawn into the device, readings will be inaccurate and device could be damaged. We recommend the use of an MSA sample probe containing a special membrane filter, permeable to gas but impermeable to water, to prevent such an occurrence.

During operation, a pump alarm may occur when the:

- Flow system is blocked
- Pump is inoperative
- Sample lines are attached or removed.

### To Clear Pump Alarm

1. Correct any flow blockage.
2. Press the ▲ button.

*The Pump will now restart.*

## 6.3 Replacing the Battery

### **WARNING!**

Never replace the battery in a hazardous area. This could result in an explosion.

**Failure to follow this warning can result in serious personal injury or death.**

---

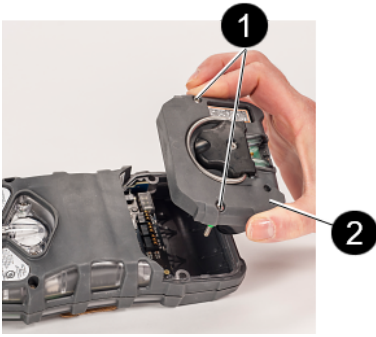

Figure 17 Battery Replacement

- 1 Captive screw    2 Battery pack

1. Unscrew the two captive screws on the rear of the device.
2. Pull the battery pack out of the device by gripping the sides and lifting it up and away from the device.
3. When replacing the battery, be sure to accurately align screws and battery with housing.
4. Screws should be tightened and torqued to 5.5 in lb.

### 6.4 Maintenance Procedure - Replacing or Adding a Sensor

Any factory-installed Series 20 sensor may be removed or replaced with another Series 20 sensor of the same gas type. Any XCell sensor may be removed or replaced according to the positions allowed in table after [Figure 18](#).

If the type of any sensor is to be changed, the device must be returned to an authorized service center.

#### **⚠ WARNING!**

- The PID sensor may be replaced with an authorized MSA PID replacement sensor. If the PID sensor range is different than the previously installed sensor, the new configuration **MUST** be selected in the Instrument Options → Sensor Setup screen prior to sensor replacement. Otherwise incorrect readings could occur and persons relying on this product for their safety could sustain serious personal injury or death.
- If your instrument was manufactured prior to July 2023, the firmware revision of the unit must be updated to revision v6.00.xx or higher prior to using the sensor included in Replacement Kit P/N 10242735. Failure to follow this warning may cause erroneous readings and could result in serious personal injury or death.
- Remove and reinstall sensors carefully, ensuring that the components are not damaged; otherwise device intrinsic safety may be adversely affected, wrong readings could occur, and persons relying on this product for their safety could sustain serious personal injury or death.

#### **NOTICE**

Before handling the PC board, ensure you are properly grounded; otherwise, static charges from your body could damage the electronics. Such damage is not covered by the warranty. Grounding straps and kits are available from electronics suppliers.



While device case is open, do not touch any internal components with metallic/conductive objects or tools. Damage to the device can occur.



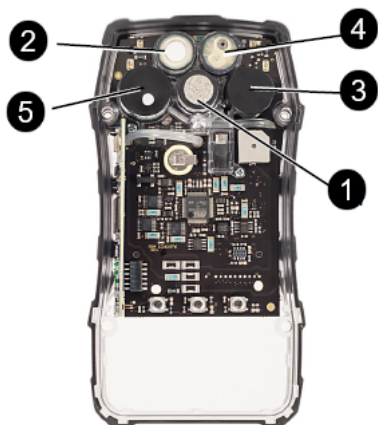

Figure 18 Possible positions for sensor replacement

- |   |                       |   |                                  |
|---|-----------------------|---|----------------------------------|
| 1 | Combustible sensor    | 4 | See table below or a sensor plug |
| 2 | O <sub>2</sub> sensor | 5 | PID sensor                       |
| 3 | See table below       |   |                                  |

SENSOR	OPERATIONAL ONLY IN POSITION
XCell combustible sensor	1
XCell Sensors: O <sub>2</sub> , CO/H <sub>2</sub> S, CO, H <sub>2</sub> S, CO-H <sub>2</sub> S-LC, CO-HC, CO/NO <sub>2</sub> , CO-H <sub>2</sub> /H <sub>2</sub> S	2
Series 20: NO <sub>2</sub> , PH <sub>3</sub> , HCN, CLO <sub>2</sub> , NO XCell: SO <sub>2</sub> , H <sub>2</sub> S, H <sub>2</sub> S-LC	3
XCell Toxic Sensors: CO/H <sub>2</sub> S, CO, H <sub>2</sub> S, CO/H <sub>2</sub> S-LC, CO-HC, CO/NO <sub>2</sub> , CO-H <sub>2</sub> /H <sub>2</sub> S, SO <sub>2</sub> , CL <sub>2</sub> , NH <sub>3</sub>	4
PID	5

1. Verify that the device is turned OFF.
2. Remove the battery pack.
3. Remove the two remaining case screws, and remove the case front.
4. Gently remove the sensor to be replaced.
5. Carefully align the new sensor contact pins with the sockets on the printed circuit board.
6. Press the new sensor into place.
7. Note the position restrictions in the table above.

*Adapter (P/N 10110183) is required for XCell usage in position 3.*

*If a sensor is removed and will not be replaced, be sure to install a sensor plug in its place in order to maintain correct device function.*

*The plug for XCell positions is P/N 10105650. The Series 20 plug is P/N 10088192.*

8. Visually inspect the green gasket, assuring that it is seated properly in the front housing.
9. Attach front case and tighten two case screws using 5.5 in-lbs of torque.
10. Attach the battery pack and tighten the two battery pack screws using 5.5 in-lbs of torque.

If a change in XCell Sensor configuration is detected during the device turn-ON process:

- The "ACCEPT?" prompt appears on the display
- The ▼ button accepts the sensor configuration

- The ▲ button rejects the sensor configuration; the device is not operational.

When an XCell sensor is replaced, the device automatically enables the sensor after the change has been accepted. If a Series 20 or PID sensor is replaced, it must be manually enabled ([5.10 Calibration](#), SETTING SENSOR OPTIONS).

If the oxygen sensor was replaced, see [5.3 Special Consideration for Oxygen Sensor](#) regarding the oxygen reading display.

11. Allow sensors to stabilize at least 30 minutes before calibration.
12. Calibrate device before use.

### **WARNING!**

Calibration is required after a sensor is installed; otherwise, the device will not perform as expected and persons relying on this product for their safety could sustain serious personal injury or death.

---

### **6.5 Replacing the Pump Filter**

1. Turn OFF the device.
2. Unscrew the two captive screws from the clear filter cover on the back of the device to access the filter.
3. Carefully lift out the O-ring and the filter disk(s).
4. Use both the paper-like filter and the fibrous dust filter (the thicker disk) as supplied in the Maintenance Kit if the device is NOT configured to use a reactive toxic gas sensor (does not have a Cl<sub>2</sub>, ClO<sub>2</sub>, or NH<sub>3</sub> sensor).

Use ONLY the paper filter supplied in the Reactive Gas Maintenance Kit if the device IS configured to use a reactive toxic gas sensor (Cl<sub>2</sub>, ClO<sub>2</sub>, or NH<sub>3</sub>).

5. Place the new paper-like filter into the recess in the back of the device. If it is to be used, place the fibrous dust filter into the clear filter cover.

### **WARNING!**

Use of the fibrous dust filter or the incorrect paper filter for the measurement of reactive gases could cause erroneous readings.

**Failure to follow this warning can result in serious personal injury or death.**

---

6. Replace the O-ring in the recess.
7. Re-install the clear filter cover on the back of the device.

### **6.6 Cleaning the Device Exterior**

Clean the exterior of the device regularly using only a damp cloth. Do not use cleaning agents, as many contain silicones that will damage the combustible sensor, or alcohols that will temporarily influence certain electrochemical sensor readings.

### **6.7 Storage**

When not in use, store the device in a safe, dry place between 18 °C (65 °F) and 30 °C (86 °F). After storage, always recheck device calibration before use. If not to be used in 30 days, remove battery pack or connect it to a charger.

### **6.8 Shipment**

Pack the device in its original shipping container with suitable padding. If the original container is unavailable, an equivalent container may be substituted.

## 6.9 PID Sensor Cleaning and Maintenance Procedure

### **⚠ WARNING!**

- All maintenance procedures must be performed on a clean surface using clean tools. Avoid touching the lamp's window as well as the metalized portion of the Cell Assembly with bare fingers. Fingerprints left on these parts may adversely affect the sensors operation. Latex gloves are recommended, but if they are not used, hands must be clean and free of oils, lotions, etc. It is acceptable to hold the lamp by its glass body or by the edges of the window.
- Remove and reinstall sensors carefully, ensuring that the components are not damaged; otherwise device intrinsic safety may be adversely affected, wrong readings could occur, and persons relying on this product for their safety could sustain serious personal injury or death.

### **NOTICE**

While device case is open, do not touch any internal components with metallic/conductive objects or tools. Damage to the device can occur.

### Cleaning Procedure

Table 1 Recommended Supplies for Cleaning

MSA PID Sensor Cleaning Kit: P/N 10165248	
Methanol	
Cotton Tipped Applicator	
Teflon Filter	
Cotton Filter	
Tweezers	
Latex Gloves (optional)	

### Prior to Cleaning

1. Verify that the device is turned OFF.
2. Remove the battery pack.
3. Remove the two remaining case screws and the case front.
4. Gently remove the PID sensor.

### Sensor Disassembly

**NOTE:** The appearance of the sensor P/N 10242693 included in Replacement Kit P/N 10242735 will differ from the pictures shown in the following section.



1. Remove the Filter Cap by applying slight upward pressure with the tip of the tweezers to the seam dividing the housing body and cap.

*This will be just below the hole in the cap.*

*The Filter Cap should pop off and can be set aside.*



2. With tweezers, remove both the Teflon Filter and Cotton Filter and set aside.



3. With tweezers, remove the Spacer and set aside.



4. With tweezers, carefully loosen the Cell Assembly by prying under the cell's edge near the three connector pins.

*Once loose, cell can be lifted out and set aside.*



5. With tweezers, grasp the lamp by placing the tips in the sensor housing notch and gently prying up on the lamp perimeter.
  - a. Lift out and be careful not to scratch the lamp lens or chip the edges.

### Cleaning



1. Hold the lamp by the cylindrical glass body.
2. Soak a cotton tipped applicator in methanol from MSA PID Sensor Cleaning Kit (P/N 10165248).

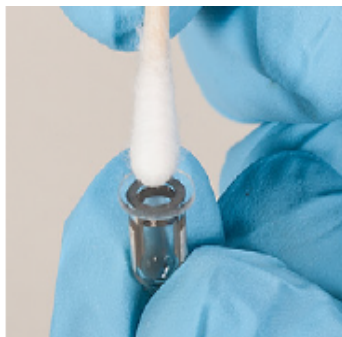

3. Rub the soaked swab on the surface of the Lamp lens in a circular motion for 60 seconds.
4. Repeat process with a dry cotton tipped applicator.
5. Allow the lamp to dry for 30 minutes before proceeding with reassembly.



Cleanliness of the PID sensor is essential for optimum performance in high humidity and temperature environments.

### Reassembly



1. Place the lamp back in the sensor, making sure that the two metalized pads are aligned with the corresponding excitation springs inside the sensor cavity.



2. Using a dry cotton tipped applicator, press the lamp down firmly to seat in the housing.

*Be careful not to scratch the lamp lens.*



3. With tweezers, reinstall the Cell Assembly.
  - a. Align the three pins with the corresponding sockets on the sensor and press this edge with a dry cotton tipped applicator to seat the Cell Assembly.
  - b. Make sure the Cell Assembly is flush with the Lamp lens.



4. Place the Spacer back in the sensor housing, surrounding the Cell Assembly.



5. Place both of the filters on top of the Cell Assembly. Make sure the Cotton Filter is installed first, followed by the Teflon Filter.

*The shiny side of the Teflon Filter should be on top.*



6. Align the Filter Cap key with the notch in the housing:
  - a. Starting at the side opposite the notch, press down the Filter Cap until it snaps onto the housing.

*If the key is incorrectly aligned, there will be a noticeable bulge on the side of the cap.*

### Device Re-assembly

1. Ensure all sensors are fully seated in the circuit board.
2. Visually inspect the green gasket, assuring that it is seated properly in the front housing.
3. Attach front case and tighten two case screws using 5.5 in-lbs of torque.
4. Attach the battery pack and tighten the two battery pack screws using 5.5 in-lbs of torque.
5. Turn on the device and verify all sensors are showing on the measuring page.
6. **Calibrate the device and ensure that all sensors show successful calibration.**

### Maintenance Procedure

Table 2 Recommended Supplies for Maintenance

MSA PID Sensor Maintenance Kit: P/N 10165247	
Cell Assembly	
Teflon Filter	
Cotton Filter	
Filter Cap	
Spacer	
Tweezers	



**MSA 0-2000 ppm 10.6eV Lamp: P/N 10165272****Background Information**

The sensor's rugged, durable design provides for trouble-free operation over the course of its lifetime. However, in certain conditions, maintenance may be required. This is customer required maintenance and is not covered under warranty.

Parts that may need cleaning or replacing over time include the UV Lamp, Cell Assembly, Teflon Filter, Cotton Filter, Cap, and Spacer. See [Table 2 Recommended Supplies for Maintenance](#).

Over time when the sensor is exposed to harsh chemicals or in a polluted environment, lamp window contamination can occur. This will degrade the sensor's performance. The contamination will block some of the UV light and decrease the sensors gain.



If several bump or calibration tests fail on the PID sensor, this is an indication that the lamp could be contaminated. Follow the Cleaning Procedure above.

**PID Error States**

**NOTE:** Instruments using firmware revision v6.00.xx or greater do not support "PID LAMP ERROR."

PID Error States	Details	Recommended Action
<b>Device Display</b>		
PID LAMP ERROR	<p>This error indicates that there is an error with the UV lamp in the PID sensor. Possible causes include:</p> <ul style="list-style-type: none"> <li>• lamp not installed</li> <li>• lamp not installed correctly</li> <li>• damaged lamp</li> <li>• non-functioning lamp.</li> </ul> <p>This test is functional at temperatures <math>\leq 30\text{ }^{\circ}\text{C}</math></p>	<p>Complete a calibration. If the device fails calibration, the device should be shut down and cleaning procedure should be followed paying careful attention to the orientation of the lamp.</p> <p>If user is not in a location where the maintenance procedure can be followed, the PID sensor can be disabled through the security menu. This will allow other functioning sensors to continue working with the PID disabled.</p> <p><b>NOTE:</b> The error may occur when installing a new PID sensor into the device. This is expected and the error will be cleared when the device is calibrated.</p>
PID SENSOR ERROR	<p>This is a fatal and non-recoverable error indicating a failure in the sensor.</p>	<p>Device should be shut down and sent to an authorized MSA repair center.</p>
<b>Calibration</b>		
Fail	<p>At the completion of the calibration sequence a Fail message is displayed. On Galaxy GX2, user can press the Calibration Details button to determine which sensor failed.</p>	<p>If PID sensor failed calibration, device should be reviewed and then calibration should be re-run. If PID calibration fails a second time, device should be shut down and the cleaning procedure should be followed.</p>

When PID LAMP ERROR is displayed, it is required to carry out the following sensor maintenance procedure.

## 7 Technical Specifications

1. Thoroughly review the PID sensor assembly and verify all components are present and installed correctly.
2. If assembly is correct then follow the lamp cleaning procedure.

*For lamp cleaning instructions, refer to Cleaning Procedure section above.*

3. If the lamp is cleaned and a PID error still exists, replace the lamp.
4. If the lamp is replaced and a PID error still exists, replace the cell assembly.

If error still exists, device should be sent to an authorized MSA repair center.

## 7 Technical Specifications

<b>Weight</b>	0.45 kg (1 lb.) - device with battery and clip
<b>Dimensions (cm)</b>	Length: 6.7 inches (169.9mm) Width: 3.5 inches (89.7mm) Height: 2.0 inches (51.4mm)
<b>Alarms</b>	LEDs, audible alarm, vibrating alarm
<b>Volume of audible alarm</b>	95 dBa at 30cm with fully charged battery, average
<b>Battery types</b>	Rechargeable Li ION battery
<b>Charging time</b>	≤ 6 hours The maximum safe area charging voltage Um = 6.7 Volts DC
<b>Normal Temperature range</b>	-10 °C to 40 °C (14 °F to 104 °F)
<b>Extended Temperature range</b>	-20 °C to 50 °C (-4 °F to 122 °F)
<b>Humidity range</b>	15 - 90 % relative humidity, non-condensing, 5 - 95 % RH intermittent
<b>Atmospheric pressure range</b>	80 kPa to 120 kPa (11.6 to 17.4 PSIA)
<b>Ingress protection</b>	IP 65
<b>Measuring methods</b>	Combustible gases - Catalytic sensor Oxygen and Toxic gases - Electrochemical sensor Volatile Organic Compounds - PID sensor
<b>Warranty</b>	See <a href="#">2.4 Warranty</a>

### Measuring Range

<b>ClO<sub>2</sub></b>	0-1.00 ppm	<b>NH<sub>3</sub></b>	0-100 ppm
<b>Cl<sub>2</sub></b>	0-10 ppm	<b>NO</b>	0-200 ppm
<b>CO</b>	0-2000 ppm	<b>NO<sub>2</sub> (S20)</b>	0-20.0 ppm
<b>CO - HC</b>	0-10,000 ppm	<b>NO<sub>2</sub> (XCell)</b>	0-50.0 ppm
<b>Combustible</b>	0-100 % LEL 0-5.00 % CH <sub>4</sub>	<b>O<sub>2</sub></b>	0-30 % Vol.
<b>H<sub>2</sub>S</b>	0-200 ppm	<b>PH<sub>3</sub></b>	0-5.00 ppm
<b>H<sub>2</sub>S - LC</b>		<b>PID</b>	0-2000 ppm
<b>HCN</b>	0-30 ppm	<b>SO<sub>2</sub></b>	0-20.0 ppm



## 7.1 Factory-Set Alarm Thresholds and Setpoints



Check the device or calibration certificate for exact alarm levels as they vary depending on national or corporate regulations.

Sensor	LOW alarm	HIGH alarm	SETPOINT min	SETPOINT max	STEL	TWA
CL <sub>2</sub>	0.5 ppm	1.0 ppm	0.3 ppm	7.5 ppm	1.0 ppm	0.5 ppm
ClO <sub>2</sub>	0.1 ppm	0.3 ppm	0.1 ppm	0.9 ppm	0.3 ppm	0.1 ppm
CO	25 ppm	100 ppm	7 ppm	1700 ppm	100 ppm	25 ppm
CO-HC	25 ppm	100 ppm	10 ppm	8500 ppm	100 ppm	25 ppm
COMB	10 % LEL	20 % LEL	5 % LEL	60 % LEL	-- <sup>1</sup>	-- <sup>1</sup>
H <sub>2</sub> S	10 ppm	15 ppm	2 ppm	175 ppm	15 ppm	10 ppm
H <sub>2</sub> S-LC	5 ppm	10 ppm	0.3 ppm	70 ppm	10 ppm	1 ppm
HCN	4.5 ppm	10.0 ppm	2.0 ppm	20.0 ppm	10 ppm	4.5 ppm
NH <sub>3</sub>	25 ppm	50 ppm	10 ppm	75 ppm	35 ppm	25 ppm
NO	25 ppm	75 ppm	15 ppm	100 ppm	25 ppm	25 ppm
NO <sub>2</sub> (S 20)	2.0 ppm	5.0 ppm	1.0 ppm	17.5 ppm	5.0 ppm	2.0 ppm
NO <sub>2</sub> (XCell)	2.5 ppm	5.0 ppm	0.5 ppm	47.5 ppm	5.0 ppm	2.5 ppm
O <sub>2</sub>	19.5 %	23.0 %	5.0 %	24.0 %	-- <sup>1</sup>	-- <sup>1</sup>
PH <sub>3</sub>	0.3 ppm	1.0 ppm	0.3 ppm	3.75 ppm	1.0 ppm	0.3 ppm
PID	50 ppm	100 ppm	2 ppm	1500 ppm	25 ppm	10 ppm
SO <sub>2</sub>	2.0 ppm	5.0 ppm	0.5 ppm	17.5 ppm	5.0 ppm	2.0 ppm

<sup>1</sup>STEL and TWA not applicable for combustible and oxygen gases.

In environments with >100 % LEL combustible gas present, devices with a catalytic combustible LEL sensor will be in a latching over-range alarm.

## 7.2 Performance Specification

Sensor	Range	Resolution	Reproducibility	Response time (typical)
<b>Combustible Gas</b>	0 to 100 % LEL or 0 to 5 % CH <sub>4</sub>	1 % LEL or 0.05 Vol % CH <sub>4</sub>	3 % LEL, 0 % to 50 % LEL reading or 0.15 % CH <sub>4</sub> , 0.00 % to 2.50 % CH <sub>4</sub> (normal temperature range)  5 % LEL, 50 % to 100 % LEL reading or 0.25 % CH <sub>4</sub> , 2.50 % to 5.00 % CH <sub>4</sub> (normal temperature range)  5 % LEL, 0 % to 50 % LEL reading or 0.25 % CH <sub>4</sub> , 0.00 % to 2.50 % CH <sub>4</sub> (extended temperature range)  8 % LEL, 50 % to 100 % LEL reading or 0.4 % CH <sub>4</sub> , 2.50 % to 5.00 % CH <sub>4</sub>	t(90)< 15 sec (Pentane) (normal temp.)  t(90)< 10 sec (Methane) (normal temp.)

## 7 Technical Specifications

Sensor	Range	Resolution	Reproducibility	Response time (typical)
			(extended temperature range)	
Oxygen	0 – 30% O <sub>2</sub>	0.1% O <sub>2</sub>	0.7 % O <sub>2</sub> for 0 – 30 % O <sub>2</sub>	t(90)< 10 sec (normal temp.)
Carbon -Monoxide	0-2000 ppm CO	1 ppm CO	±5 ppm CO or 10 % of reading, whichever is greater (normal temperature range)	t(90)< 15 sec (normal temp.)
			±10 ppm CO or 20 % of reading, whichever is greater (extended temperature range)	
Hydrogen Sulfide	0-200 ppm H <sub>2</sub> S	1 ppm H <sub>2</sub> S, for 3 to 200 ppm H <sub>2</sub> S	±2 ppm H <sub>2</sub> S or 10 % of reading, whichever is greater (normal temperature range)	t(90)< 15 sec (normal temp.)
			±5 ppm H <sub>2</sub> S or 20 % of reading, whichever is greater (extended temperature range)	

Sensor	Range (ppm)	Resolution (ppm)	Reproducibility		Response time (typical)*
			Normal temperature range:	Extended temp. range:	
Cl <sub>2</sub> Chlorine	0 - 10	0.05	±0.2 ppm or 10 % of reading, whichever is greater	±0.5 ppm or 20 % of reading, whichever is greater	t(90)< 30 s
ClO <sub>2</sub> Chlorine dioxide	0 - 1	0.01	±0.1 ppm or 10 % of reading, whichever is greater	±0.2 ppm or 20 % of reading, whichever is greater	t(90)< 2 min
CO-HC Carbon - Monoxide	0 - 10000	5	±5 ppm or 10 % of reading, whichever is greater	±10 ppm or 20 % of reading, whichever is greater	t(90)< 15 s
H <sub>2</sub> S-LC Hydrogen Sulfide	0 - 100	0.1	±0.2 ppm or 10 % of reading, whichever is greater	±0.5 ppm or 20 % of reading, whichever is greater	t(90)< 15 s
HCN Hydrogen cyanide	0 - 30	0.5	±1 ppm or 10 % of reading, whichever is greater	±2 ppm or 20 % of reading, whichever is greater	t(90)< 30 s
NH <sub>3</sub> Ammonia	0 - 100	1	±2 ppm or 10 % of reading, whichever is greater	±5 ppm or 20 % of reading, whichever is greater	t(90)< 40 s
NO <sub>2</sub> Nitrogen dioxide (S 20)	0 - 20	0.1	±2 ppm or 10 % of reading, whichever is greater	±3 ppm or 20 % of reading, whichever is greater	t(90)< 40 s
NO <sub>2</sub> Nitrogen dioxide (XCell)	0 - 50	0.1	±1 ppm or 10 % of reading, whichever is greater	±2 ppm or 20 % of reading, whichever is greater	t(90)< 15 s
NO Nitric oxide	0 - 200	1	±5 ppm or 10 % of reading, whichever is greater	±10 ppm or 20 % of reading, whichever is greater	t(90)< 40 s
PH <sub>3</sub>	0 - 5	0.05	±0.2 ppm or 10 %	±0.25 ppm or 20 %	t(90)< 30 s

Sensor	Range (ppm)	Resolution (ppm)	Reproducibility		Response time (typical)*
			Normal temperature range:	Extended temp. range:	
Phosphine			of reading, whichever is greater	of reading, whichever is greater	
PID	0-2000	0.1 (0-999ppm) 1 (1000-2000ppm)	±5 ppm or 10 % of reading, whichever is greater	±10 ppm or 20 % of reading, whichever is greater	t(90)< 10 s
SO <sub>2</sub> Sulfur dioxide	0 - 20	0.1	±2 ppm or 10 % of reading, whichever is greater	±3 ppm or 20 % of reading, whichever is greater	t(90)< 20 s

\*Response time is for normal temperature range with sensor in position #3.

## 7.3 Calibration Specifications

Sensor	Zero Gas	Zero Cal Value	Span Cal Gas	Span Cal	
				Value	Time (min)
COMB Pentane <sup>1,2</sup>	Fresh Air	0	1.45 % Vol Methane	58 % LEL	1
COMB Methane (0 - 5 % Vol)	Fresh Air	0	2.5 % Vol Methane	2.5 %	1
COMB Methane (4.4 % Vol) <sup>1</sup>	Fresh Air	0	1.45 % Vol Methane	33 % LEL	1
COMB Methane (5 % Vol)	Fresh Air	0	1.45 % Vol Methane	29 % LEL	1
COMB Propane (1.7 % Vol) <sup>1,2</sup>	Fresh Air	0	1.45 % Vol Methane	46 % LEL	1
COMB Propane (2.1 % Vol) <sup>1,2</sup>	Fresh Air	0	1.45 % Vol Methane	37 % LEL	1
COMB Butane (1.4 % Vol) <sup>1,2</sup>	Fresh Air	0	1.45 % Vol Methane	45 % LEL	1
COMB Hydrogen (4,0 % Vol) <sup>1,2</sup>	Fresh Air	0	1.45 % Vol Methane	33 % LEL	1
O <sub>2</sub>	Fresh Air	20.8 %	15 % O <sub>2</sub>	15 %	1
CO	Fresh Air	0	60 ppm CO	60 ppm	1
H <sub>2</sub> S	Fresh Air	0	20 ppm H <sub>2</sub> S	20 ppm	1
SO <sub>2</sub>	Fresh Air	0	10 ppm SO <sub>2</sub>	10 ppm	1
Cl <sub>2</sub>	Fresh Air	0	10 ppm Cl <sub>2</sub>	10 ppm	2
NO	Fresh Air	0	50 ppm NO	50 ppm	4
NO <sub>2</sub>	Fresh Air	0	10 ppm NO <sub>2</sub>	10 ppm	2
NH <sub>3</sub>	Fresh Air	0	25 ppm NH <sub>3</sub>	25 ppm	2
PH <sub>3</sub>	Fresh Air	0	0.5 ppm PH <sub>3</sub>	0.5 ppm	1
HCN	Fresh Air	0	10 ppm HCN	10 ppm	4
ClO <sub>2</sub> <sup>2</sup>	Fresh Air	0	2 ppm Cl <sub>2</sub>	0.8 ppm	6
PID	Fresh Air	0	100 ppm isobutylene	100 ppm	1

Span values can be changed if using different gas cylinders than those listed. Changes can be made using MSA Link software and through calibration cylinder setup.

<sup>1</sup>Calibration approach is only valid when the device is configured to display %LEL units.

<sup>2</sup>Calibration approach promotes direct device readings that align with the sensor gas, not the span cal gas. For most accurate results, calibration with the gas of interest is recommended.

### WARNING!

Any changes to the standard calibration process must be reviewed by a trained and qualified individual. If changing the span cal gas that is applied to the device or the span cal value of the device from those listed above, the user must ensure that cal gas and span settings match prior to performing a calibration (5.10 Calibration). Additional care should be taken to ensure range and units of the span value are in line with the concentration of the cal gas cylinder being used.

**Failure to follow this warning can result in serious personal injury or death.**



LEL values, if not listed here, are according to EN 60079-20-1. Local regulations may differ.

## 7.4 Combustible Gas Cross Reference Factors for General-Purpose Calibration

Combustible Gas	Methane Calibration 1.45 Vol % CH <sub>4</sub> Set 33 % LEL	Pentane Simulant Calibration 1.45 Vol % CH <sub>4</sub> Set 58 % LEL
Acetone*	1.09	0.62
Acetylene	1.07	0.61
Butane	1.37	0.79
Cyclohexane	1.94	1.11
Diethylether*	1.43	0.82
Ethane	1.27	0.73
Ethanol*	1.16	0.66
Ethylene	1.09	0.62
Gasoline	1.63	0.93
n-Hexane	1.86	1.06
Hydrogen	0.98	0.56
Isobutane	1.63	0.93
Isopropyl Alcohol*	1.55	0.88
Methane	1.00	0.57
Methanol*	0.93	0.53
Methyl Ethyl Ketone	1.69	0.97
Nonane*	4.48	2.56
Nonane with EX-H sensor	3.03	1.73
Pentane	1.90	1.00
Propane	1.39	0.79
Propylene	1.14	0.65
Toluene*	2.09	1.19
Xylene*	4.83	2.76
Xylene with EX-H sensor	3.57	2.04

**NOTE:** Gas in the table above indicated with a \* will have significantly longer response times, especially at lower concentration levels.

**Response notes**

1. Some compounds may reduce the sensitivity of the combustible gas sensor by poisoning or inhibiting the catalytic action or by polymerizing on the catalytic surface.
2. Multiply the displayed % LEL value by the conversion factor above to get the true % LEL. The conversion cross reference factors above are only applicable when the device is configured to display %LEL units, not %Vol units.
3. These conversion factors should be used only if the combustible gas is known.
4. All factors are based on the IEC 100 % LEL levels
  - a. i.e. Methane 100% LEL = 4.4 Vol %,
  - b. Pentane 100% LEL = 1.1 Vol %
  - c. Propane 100% LEL = 1.7 Vol %
5. These conversion factors are typical. Individual units may vary by  $\pm 25$  % from these values.

## 8 XCell Sensor Patents

---

6. The results are intended for guidance only. For the most accurate measurements, a device should be calibrated using the gas under investigation.
7. The conversion factors for the standard EX and the specialized EX-H and EX-M sensor are the same except for EX-H and Nonane and o-Xylene. The conversion factors for these two vapors are therefore especially mentioned in the table.

### 8 XCell Sensor Patents

<b>SENSOR</b>	<b>PART NUMBER</b>	
Combustible	10106722	US8826721
Oxygen	10106729	US8790501
Carbon Monoxide / Hydrogen Sulfide	10106725	US8790501, US8702935
Ammonia	10106726	US8790501, US8623189
Chlorine	10106728	US8790501, US8623189
Sulphur Dioxide	10106727	US8790501, US8623189

## 9 Ordering Information

### 9.1 US

#### Gas Cylinder Parts List

Gases	Gases Mix	MSA P/N		Recommended CAL Gas for:
		ECONO-CAL (34 L)	RP (58 L)	
1	100 ppm isobutylene	10048279	494450 (100 L)	0-2000 ppm PID
1	10 ppm NO <sub>2</sub> in Air	711068	808977	NO <sub>2</sub> sensor
1	10 ppm SO <sub>2</sub> in Air	711070	808978	SO <sub>2</sub> sensor
1	25 ppm NH <sub>3</sub> in N <sub>2</sub>	711078	814866	NH <sub>3</sub> sensor
1	10 ppm Cl <sub>2</sub> in N <sub>2</sub>	711066	806740	Cl <sub>2</sub> sensor
1	2 ppm Cl <sub>2</sub> in N <sub>2</sub>	711082	10028080	ClO <sub>2</sub> sensor
1	10 ppm HCN in N <sub>2</sub>	711072	809351	HCN sensor
1	0.5 ppm PH <sub>3</sub> in N <sub>2</sub>	711088	710533	PH <sub>3</sub> sensor
3	1.45 % CH <sub>4</sub> , 15.0 % O <sub>2</sub> , 20 ppm H <sub>2</sub> S	10048790	10048788	
3	2.50 % CH <sub>4</sub> , 15.0 % O <sub>2</sub> , 20 ppm H <sub>2</sub> S	10048888	10048889	
3	1.45 % CH <sub>4</sub> , 15.0 % O <sub>2</sub> , 60 ppm CO	10048789	478191(100L)	
3	2.50 % CH <sub>4</sub> , 15.0 % O <sub>2</sub> , 60 ppm CO	10049056	813718 (100L)	
4	1.45 % CH <sub>4</sub> , 15.0 % O <sub>2</sub> , 60 ppm CO, 10 ppm NO <sub>2</sub>	10058036	10058034	
4	1.45 % CH <sub>4</sub> , 15.0 % O <sub>2</sub> , 60 ppm CO, 20 ppm H <sub>2</sub> S	10048280	10045035	
4	2.50 % CH <sub>4</sub> , 15.0 % O <sub>2</sub> , 60 ppm CO, 20 ppm H <sub>2</sub> S	10048981	10048890	
4	2.50 % CH <sub>4</sub> , 15.0 % O <sub>2</sub> , 60 ppm CO, 10 ppm NO <sub>2</sub>	10058172	10058171	
5	1.45 % CH <sub>4</sub> , 15.0 % O <sub>2</sub> , 60 ppm CO, 20 ppm H <sub>2</sub> S, 10 ppm SO <sub>2</sub>	10098855	10117738	SO <sub>2</sub> sensor

## 9 Ordering Information

### 9.2 Outside US

Description	Part Number
<b>Gas</b>	
Cylinder 34L, 60 ppm CO	10073231
Cylinder 34L, 40 ppm H <sub>2</sub> S	10011727
Cylinder 34L, 25 ppm NH <sub>3</sub>	10079807
Cylinder 34L, 10 ppm Cl <sub>2</sub>	10011939
Cylinder 34L, 10 ppm SO <sub>2</sub>	10079806
Cylinder 34L, 10 ppm NO <sub>2</sub>	10029521
Cylinder 34L, 0.5 ppm PH <sub>3</sub>	10029522
Cylinder 34L, 2 ppm Cl <sub>2</sub> (To calibrate ClO <sub>2</sub> sensor)	711082
Cylinder 34L, 10 ppm HCN	711072
Cylinder 34L, 100 ppm Isobutylene	10169196
Calibration Cylinder 58L (1.45 % CH <sub>4</sub> , 15.0 % O <sub>2</sub> , 60 ppm CO, 20 ppm H <sub>2</sub> S)	10053022
Calibration Cylinder 58L (1.45 % CH <sub>4</sub> , 15.0 % O <sub>2</sub> , 60 ppm CO, 20 ppm H <sub>2</sub> S)	10045035
Cylinder 34L, 50 ppm NO	10126429
Cylinder 58L (0,4 % Propane, 15 % O <sub>2</sub> , 60 ppm CO, 20 ppm H <sub>2</sub> S)	10086549
Cylinder 34L (1.45 % CH <sub>4</sub> , 15 % O <sub>2</sub> , 60 ppm CO, 20 ppm H <sub>2</sub> S, 10 ppm SO <sub>2</sub> )	10122425
Cylinder 58L (1.45 % CH <sub>4</sub> , 15 % O <sub>2</sub> , 60 ppm CO, 20 ppm H <sub>2</sub> S, 10 ppm SO <sub>2</sub> )	10122426

### 9.3 Accessories

Description	Part Number
Universal Demand Regulator kit	10034391
MSA Link USB dongle	10082834
MSA Link Datalogging Software	10088099
Shoulder Strap	474555
North America only: Retractable Line with Belt Clip	10050976
Holster, leather	10099648
Altair Hand Probe	10153041
Quick Conector, Altair Hand Probe	10161755
Sampling line, 5ft, PU, non-conductive	10153217
Sampling line, 10ft, PU, non-conductive	10153218
Sampling line, 15ft, PU, non-conductive	10153219
Sampling Probe, flexible 30 cm, conductive	10103191
Sampling Line, 1,5 m, conductive	10103188
Sampling Line, 3 m, conductive	10103189
Sampling Line, 5 m, conductive	10103190



Description	Part Number
Sampling Line, 20 m, conductive	10159430
Sampling Line, 30 m, conductive	10159431
Sampling System w/floating probe, 5 m, PU conductive	10082307
Probe, 1 ft. straight PEEK	10042621
Probe, 3 ft. straight PEEK	10042622
Polyurethane Sample Line, 10 ft.	10040665
Polyurethane Sample Line, 25 ft.	10040664
Polyurethane Sample Line, 3 ft. Coiled	10040667
(Cl <sub>2</sub> , ClO <sub>2</sub> , NH <sub>3</sub> ) 5 ft. PU Sample line & probe, kit	10105251
(Cl <sub>2</sub> , ClO <sub>2</sub> , NH <sub>3</sub> )10 ft. Teflon Sample line & probe, kit	10105839
Replacement Filters for probe, 10 pack	801582
Charger only (North America)	10087913
Charger only (Global version)	10092936
Charging Cradle with Barrier- (North America)	10093055
Charging Cradle - (North America)	10093054
Charging Cradle (Europe)	10093057
Charging Cradle (Australia)	10093056
Vehicle Charger Cradle	10099397
Cradle Only - (no charger)	10093053
ALTAIR 5/5X Multi-Unit Charger, 4 Unit (North American)	10127427
ALTAIR 5/5X Multi-Unit Charger, 4 Unit (Europe)	10127428
ALTAIR 5/5X Multi-Unit Charger, 4 Unit (UK)	10127429
ALTAIR 5/5X Multi-Unit Charger, 4 Unit (Australia)	10127430
ALTAIR 5/5X Multi-Unit Charger, 4 Unit No Power Cord	10128704
Carrying Case	10152079
Altair 5/ 5X Identifier Labels, 128 units, Blue	10177767
Altair 5/ 5X Identifier Labels, 128 units, Red	10177768
Altair 5/ 5X Identifier Labels, 128 units, Green	10177769
Altair 5/ 5X Identifier Labels, 128 units, Orange	10177770
Altair 5/ 5X Identifier Labels, 128 units, Yellow	10177771
Screwdriver, PHILLIPS/3MM HEX/1/16 HEX	10025550



Not all accessories are available in every local market. Check availability with the local MSA representative

9.4 Replacement Parts

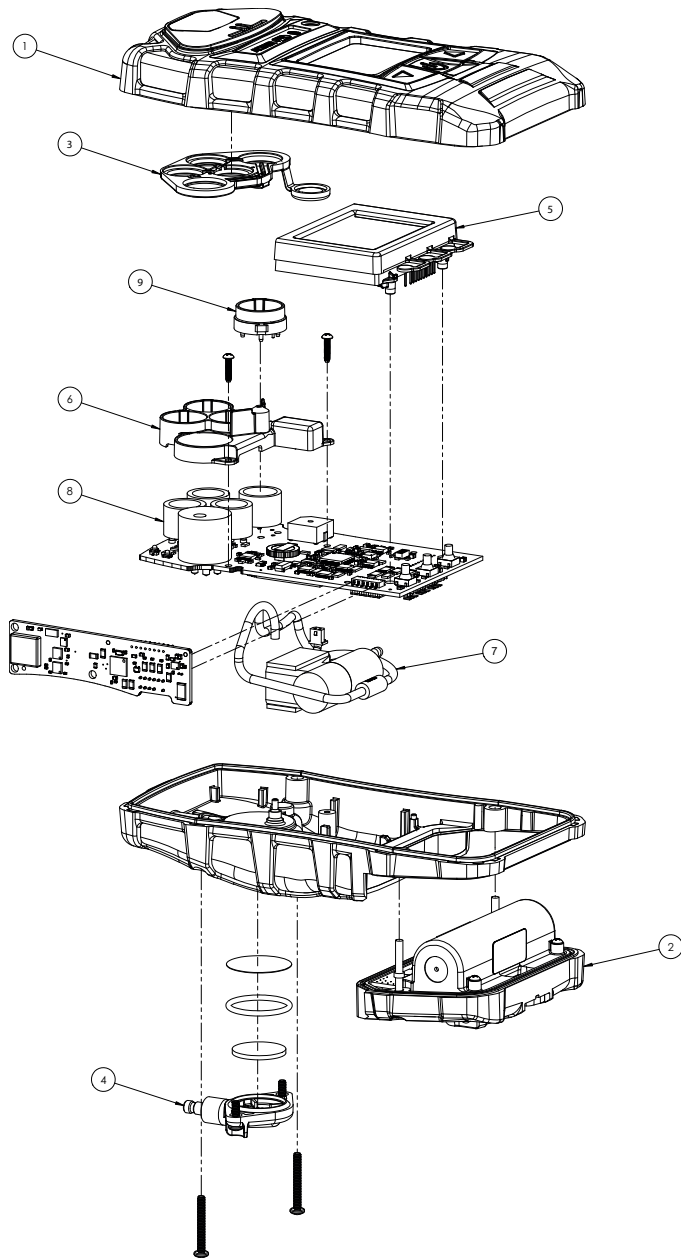

No.	Description	Part Number
1	Case Assembly, Front w/ Bluetooth, ALTAIR 5X PID	10165249
	Case Assembly, Front NO Bluetooth, Altair 5X PID	10236060
2	Battery Pack, Rechargeable, North America, ALTAIR 5X PID/IR	10114839
	Battery Pack, Rechargeable, EU/Aus, ALTAIR 5X PID/IR	10114851
3	Kit, PID Sensor, Maintenance (Cell Assembly, Cap, Spacer, Filters, Tweezers)	10165247
	Kit, PID Sensor, Cleaning (Filters, Tweezers, Methanol & Cotton Applicators)	10165248
	Kit, Instrument Maintenance, ALTAIR 5X PID (Filters, O-ring, Screws, Green Gaskets)	10165285
	Kit, Instrument Maintenance, Reactive (Cl <sub>2</sub> , ClO <sub>2</sub> , NH <sub>3</sub> ), ALTAIR 5X PID (Filters, O-ring, Screws, Green Gaskets)	10165284

No.	Description	Part Number
	Filter, Dust	808935
	Filter, Reactive Gas	10064531
4	Filter Cover Assembly, ALTAIR 5X PID	10165275
5	Color Display Assembly, ALTAIR 5X	10148366-SP
6	Sensor Bracket and Vibe Motor Assembly, ALTAIR 5X PID	10165273
7	Pump Assembly, ALTAIR 5X PID	10165274
8	Sensor, HCN (Series 20)	10106375
	XCell Sensor, Cl <sub>2</sub>	10106728
	Sensor, ClO <sub>2</sub> (Series 20)	10080222
	XCell Sensor, SO <sub>2</sub>	10106727
	Sensor, NO <sub>2</sub> (Series 20)	10080224
	XCell Sensor, NH <sub>3</sub>	10106726
	Sensor, PH <sub>3</sub> (Series 20)	10116638
	XCell Sensor, COMB	10106722
	XCell Sensor, O <sub>2</sub>	10106729
	XCell Sensor, CO	10106724
	XCell Sensor, H <sub>2</sub> S	10106723
	XCell Sensor, CO-H <sub>2</sub> S, Two-Tox	10106725
	XCell Sensor, CO/ NO <sub>2</sub>	10121217
	XCell Sensor, CO-HC	10121216
	XCell Sensor, H <sub>2</sub> S-LC/CO	10121213
	XCell Sensor, CO-H <sub>2</sub> Res/H <sub>2</sub> S	10121214
	Sensor, NO (Series 20)	10114750
	XCell Sensor plug	10105650
	20 mm sensor plug	10088192
	Sensor, PID, 0-2000ppm	10165271
	Lamp, 0-2000ppm PID sensor, 10.6eV	10165272
9	Series 20 to XCell Adapter Socket	10110183

## 10 PID Response Factor Table

### WARNING!

VOC Response factors apply in the 0-500 ppm range. The values in this table were obtained using dry bottled gases at room temperature. The response factors may change at higher concentrations, different temperature and humidity conditions, or with cleanliness of lamp. For increased accuracy at different ambient conditions or concentrations, determine a custom response factor and enter it via the Custom Gas page; see [5.5 Device Setup](#), Custom Gas Setup. These response factors are specific to the energy of the lamp designated in the table. They are not valid for devices using PID lamps at any other energy. Using these response factors with a lamp at any other energy may critically compromise the device's ability to detect volatile organic compounds which can result in serious personal injury or death.

### WARNING!

Use of ALTAIR 5X PID with PID for detection of extremely toxic gases: The system resolution limit of the ALTAIR 5X PID in normal mode (with a new, clean lamp) is approximately 0.1 ppm isobutylene equivalent. Users must be aware of exposure limit guidelines, such as TLV, for the target compound. Do not use the ALTAIR 5X PID Detector if the exposure limit for the target compound is below 0.1 ppm. Failure to follow this warning can cause over-exposure, which can result in serious personal injury or death.

For any compound, its exposure limit guideline can be recalculated in terms of equivalent ppm isobutylene by dividing the exposure limit guideline by the appropriate response factor. Example: For butyl acetate (CAS 123-86-4), the recommended threshold limit value (as TWA) is 150 ppm. Its response factor (10.6 eV lamp) is 2.4. The TLV for butyl acetate, in terms of equivalent ppm isobutylene is:  $150 \text{ ppm} \div 2.4 = 62.5 \text{ ppm isobutylene equivalent}$ .

Gases with very high response Factors (RF): The ALTAIR 5X PID is a very versatile solution for monitoring many different gases and vapors. In addition to the pre-programmed list provided in the ALTAIR 5X PID device, users can determine response factors for many other compounds (see following section). The maximum response factor value that will be accepted by the ALTAIR 5X PID device is 39.99.

**Failure to follow these warnings can result in serious personal injury or death.**

### WARNING!

The ALTAIR 5X PID Detector has a reproducibility of  $\pm 2 \text{ ppm} (\pm 5000 \text{ ppb})$  or 10%, whichever is greater (see table in [7.2 Performance Specification](#)). The user must account for this potential variation between the displayed value and the actual concentration when setting alarms and interpreting readings.

**Failure to comply with this warning can cause over-exposure and result in serious personal injury or death.**

### WARNING!

Use the correct lamp when determining the response factor.

**Failure to apply the appropriate response factors can result in inaccurate readings, and serious injury or death can occur.**

Contact MSA Customer Service at 1-800-MSA-2222 with any question regarding the above information.

COMPOUND NAME	Display Name	Synonym(s)	CAS Number <sup>1</sup>	Chemical Formula	Ionization Potential	RF 10.6eV lamp
acetaldehyde	ETHANAL		75-07-0	C2H4O	10.23	10.8
acetone	ACETONE	2-Propanone	67-64-1	C3H6O	9.71	1.2
acetophenone	ACETPHEN		98-86-2	C8H8O	9.28	0.59

COMPOUND NAME	Display Name	Synonym(s)	CAS Number <sup>1</sup>	Chemical Formula	Ionization Potential	RF 10.6eV lamp
acrolein	ACROLEIN		107-02-8	C3H4O	10.1	3.9
allyl alcohol	PROPENOL		107-18-6	C3H6O	9.67	2.5
amyl acetate	AMYLACET	mix of n-Pentyl acetate & 2-Methylbutyl acetate	628-63-7	C7H14O2		3.5
arsine	ARSINE	Arsenic trihydride	7784-42-1	AsH3	9.89	2.6
benzene	BENZENE		71-43-2	C6H6	9.25	0.53
bromoform	BRFORM	Tribromomethane	75-25-2	CHBr3	10.48	2.3
bromomethane	MEBR	Methyl bromide	74-83-9	CH3Br	10.54	1.8
butadiene	BUTADIEN	1,3-Butadiene, Vinyl ethylene	106-99-0	C4H6	9.07	0.69
butanol, 1-	BUTANOL	Butyl alcohol, n-Butanol	71-36-3	C4H10O	9.99	3.4
butoxyethanol, 2-	BTOXETOH	Butyl Cellosolve, Ethylene glycol monobutyl ether	111-76-2	C6H14O2	<10	1.3
butyl acetate	BTYLACET		123-86-4	C6H12O2	10	2.4
Butyl Acrylate	*	Acrylic acid butyl ester	141-32-2	C7H12O2		6.8
butyl alcohol, tert-	TBUOH	tert-Butanol, t-Butyl alcohol, t-butanol	75-65-0	C4H10O	9.9	3.4
butyl mercaptan, tert-	TBUMRCAP	1-Butanethiol	109-79-5	C4H10S	9.14	0.55
butylamine, tert-	TBUAMINE	Butylamine, t-	75-64-9	C4H11N	8.5	0.71
carbon disulfide	CS2		75-15-0	CS2	10.07	1.2
Chloroacetyl Chloride	*	Chloroacetic chloride	79-04-9	C2H2CL2O		13.7
chlorobenzene	CLBNZ	Monochlorobenzene	108-90-7	C6H5Cl	9.06	0.4
cumene	CUMENE	Isopropylbenzene	98-82-8	C9H12	8.73	0.54
cyclohexane	CYCHEXAN		110-82-7	C6H12	9.86	1.5
cyclohexanone	CYCHEXON		108-94-1	C6H10O	9.14	0.82
decane	DECANE		124-18-5	C10H22	9.65	1.6
Diacetone alcohol	PYRATON	4-Methyl-4-hydroxy-2-pentanone	123-42-2	C6H12O2	9.50	0.55
dibromoethane, 1,2-	EDB	EDB, Ethylene dibromide, Ethylene bromide	106-93-4	C2H4Br2	10.37	11.7
dichlorobenzene, 1,2-	O-DCLBNZ	dichlorobenzene, o-	95-50-1	C6H4Cl2	9.08	0.5
Dichloroethene, trans-1,2-	DCETHENE	t-1,2-DCE, trans-Dichloroethylene	156-60-5	C2H2Cl2	9.65	0.45
diesel fuel #1	DIESEL		68334-30-5	m.w. 226		0.9
diesel fuel #2	DIESEL		68334-30-5	m.w. 216		0.75

**10 PID Response Factor Table**

COMPOUND NAME	Display Name	Synonym(s)	CAS Number <sup>1</sup>	Chemical Formula	Ionization Potential	RF 10.6eV lamp
diethylamine	DEA		109-89-7	C <sub>4</sub> H <sub>11</sub> N	8.01	1
dimethoxymethane	METHYLAL	Methylal	109-87-5	C <sub>3</sub> H <sub>8</sub> O <sub>2</sub>	10	11.3
dimethyl disulfide	DMDS	DMDS	624-92-0	C <sub>2</sub> H <sub>6</sub> S <sub>2</sub>	7.4	0.3
dimethylacetamide, n,n-	DMA	DMA	127-19-5	C <sub>4</sub> H <sub>9</sub> NO	8.81	0.73
Dimethylamine	*			C <sub>2</sub> H <sub>7</sub> N	8.24	2.3
dimethylformamide, n,n-	DMF	DMF	68-12-2	C <sub>3</sub> H <sub>7</sub> NO	9.13	0.8
Dimethylpropylamine (DMPA)	*	N,N-Dimethyl-1-propanamine	926-63-6	C <sub>5</sub> H <sub>13</sub> N		1.0
dioxane, 1,4-	DIOXANE		123-91-1	C <sub>4</sub> H <sub>8</sub> O <sub>2</sub>	9.19	1.4
epichlorhydrin	EPCLHYD	ECH Chloromethyloxirane, 1-chloro-2,3-epoxypropane	106-89-8	C <sub>2</sub> H <sub>5</sub> ClO	10.2	7.6
ethanol	ETHANOL	Ethyl alcohol	64-17-5	C <sub>2</sub> H <sub>6</sub> O	10.47	10
ethyl acetate	ETACET	Acetic ether; Ethyl acetic ester; Ethyl ethanoate	141-78-6	C <sub>4</sub> H <sub>8</sub> O <sub>2</sub>	10.01	4.2
ethyl acetoacetate	EAA		141-97-9	C <sub>6</sub> H <sub>10</sub> O <sub>3</sub>		0.9
ethyl acrylate	ETHYLACR		140-88-5		<10.3	2.3
ethyl ether	ETETHER	Diethyl ether	60-29-7	C <sub>4</sub> H <sub>10</sub> O	9.51	1.2
ethyl mercaptan	ETMERCAP	Ethanethiol	75-08-1	C <sub>2</sub> H <sub>6</sub> S	9.31	0.6
ethylbenzene	ETBNZE		100-41-4	C <sub>8</sub> H <sub>10</sub>	8.77	0.51
ethylene	ETHYLENE	ethene	74-85-1	C <sub>2</sub> H <sub>4</sub>	10.51	10.0
ethylene glycol	ETGLYCOL	1,2-Ethandiol	107-21-1	C <sub>2</sub> H <sub>6</sub> O <sub>2</sub>	10.16	15.7
ethylene oxide	ETOXIDE	Oxirane, Epoxyethane	75-21-8	C <sub>2</sub> H <sub>4</sub> O	10.57	19.5
gasoline (summary hydrocarbons)	GASOLINE		8006-61-9	m.w. 72		1.1
heptane	HEPTANE		142-82-5	C <sub>7</sub> H <sub>16</sub>	9.92	2.5
hexane, n-	HEXANE		110-54-3	C <sub>6</sub> H <sub>14</sub>	10.13	4.5
hydrazine	HYDRAZINE		302-01-2	H <sub>4</sub> N <sub>2</sub>	8.1	2.6
hydrogen sulfide	H <sub>2</sub> S		7783-06-04	H <sub>2</sub> S	10.45	3.2
isoamyl acetate	IAMYACET	Isopentyl acetate	123-92-2	C <sub>7</sub> H <sub>14</sub> O <sub>2</sub>	<10	1.8
isobutanol	IBUTANOL	2-Methyl-1-propanol	78-83-1	C <sub>4</sub> H <sub>10</sub> O	10.02	4.7
isobutene	ISOBUTYL	Isobutylene, Methyl butene	115-11-7	C <sub>4</sub> H <sub>8</sub>	9.22	1
isobutyl acetate	IBUACET	2-methylpropyl acetate, β-methylpropyl ethanoate	110-19-0	C <sub>6</sub> H <sub>12</sub> O <sub>2</sub>	9.97	2.6
isooctane	IOCTANE	2,2,4-Trimethylpentane	540-84-1	C <sub>8</sub> H <sub>18</sub>	9.86	1.3
isopentane	ISOPENT	2-Methylbutane	78-78-4	C <sub>5</sub> H <sub>12</sub>	10.32	8

COMPOUND NAME	Display Name	Synonym(s)	CAS Number <sup>1</sup>	Chemical Formula	Ionization Potential	RF 10.6eV lamp
isophorone	IPHORNE		78-59-1	C9H14O	9.07	0.74
isoprene	ISOPRENE	2-Methyl-1,3-butadiene	78-79-5	C5H8	8.86	0.6
isopropanol	IPA	Isopropyl alcohol, 2-propanol, IPA	67-63-0	C3H8O	10.12	5.6
isopropyl acetate	ISOPRACE		108-21-4		9.99	2.6
isopropyl ether	IPTROETHR	Diisopropyl ether	108-20-3	C6H14O	9.2	0.8
isopropylamine	2PRAMINE		75-31-0	C3H9N	8.6	0.9
Jet A fuel	JETA(A1)	F-34, Kerosene type aviation fuel	8008-20-6	m.w. 145		0.4
JP-5 fuel	JP5	Jet 5, F-4 4, Kerosene type aviation fuel	8008-20-6	m.w. 167		0.48
JP-8 fuel	JP8	F-34, Kerosene type aviation fuel	8008-20-6	m.w. 165		0.48
Limonene	*	(R)-(+)-Limonene	5989-27-5	C10H16		0.52
mesityl oxide	MSTYLOXD		141-79-7	C6H10O	9.1	0.47
methoxyethanol, 2-	MEOXETOH	Methyl cellosolve, Ethylene glycol monomethyl ether	109-86-4	C3H8O2	10.1	2.5
methyl acetate	MEACET		79-20-9	C3H6O2	10.27	7
methyl acetoacetate	MEACACET		105-45-3	C5H8O3	9.82	1.1
methylacrylic acid	*	2-Methacrylic acid, 2-Methylpropenoic acid	79-41-4			4.6
methyl acrylate	MEACRYLT	Methyl 2-propenoate, Acrylic acid methyl ester	96-33-3	C4H6O2	9.9	3.4
methyl benzoate	MEBNZOTE		93-58-3	C8H8O2	9.32	0.93
methyl ethyl ketone	MEK	MEK, 2-Butanone	78-93-3	C4H8O	9.51	0.9
methyl isobutyl ketone	MIBK	MIBK, 4-Methyl-2-pentanone	108-10-1	C6H12O	9.3	1.1
methyl mercaptan	METHMERC	Methanethiol	74-93-1	CH4 S	9.44	0.6
methyl methacrylate	MEMEACRY		80-62-6	C5H8O2	9.7	1.5
methyl tert-butyl ether	MTBE	MTBE, tert-Butyl methyl ether	1634-04-4	C5H12O	9.24	0.86
methylamine	MEAMINE	Aminomethane	74-89-5	CH5N	8.97	1.2
methylbenzyl alcohol, 4-	MEBNZOL		589-18-4	C8H10O		0.8
Methyldiethoxysilane	*			C <sub>5</sub> H <sub>14</sub> O <sub>2</sub> Si		0.9
naphthalene	NAPHTH	Mothballs	91-20-3	C10H8	8.13	0.37
nitric oxide	NO		10102-43-9	NO	9.26	7.2
Nitrobenzene	*		98-95-3	C6H5NO2	9.81	5.3

**10 PID Response Factor Table**

COMPOUND NAME	Display Name	Synonym(s)	CAS Number <sup>1</sup>	Chemical Formula	Ionization Potential	RF 10.6eV lamp
nitrogen dioxide	NO2		10102-44-0	NO2	9.59	10
nonane, n-	NONANE		111-84-2	C9H20	9.71	1.6
octane	OCTANE		111-65-9	C8H18	9.82	2.2
pentane, n-	PENTANE		109-66-0	C5H12	10.35	9.7
pentanone, 2-	PENT2ONE	MPK, 2-Pentanone, Methyl propyl ketone	107-87-9	C5H10O	9.38	0.78
phenol	PHENOL	Hydroxybenzene	108-95-2	C6H6O	8.51	1
phosphine	PHOSPHIN		7803-51-2	PH3	9.87	2.8
picoline, 2-	2PICOLIN		109-06-8	C6H7N	9.23	0.57
picoline, 3-	3PICOLIN	3-Methylpyridine	108-99-6	C6H7N	9.04	0.9
pinene, alpha	PINENEA		80-56-8		8.07	0.4
pinene, beta	PINENEB		127-91-3			0.4
propanol, 1-	PROPANOL		71-23-8	C3H8O	10.22	5.7
propionaldehyde	PROPANAL	Propanal	123-38-6	C3H6O	9.96	14.8
propyl acetate, n-	PRACETAT		109-60-4		9.98	3.1
propylene	PROPENE	Propene	115-07-1	C3H6	9.73	1.3
Propylene glycol methyl ether	MEOXPROP	PGME, 1-methoxy-2-propanol	107-98-2	C4H10O2	9.54	1.4
propylene oxide	PROPLYOX	Methyloxirane	75-56-9	C3H6O	10.22	6.5
pyridine	PYRIDINE		110-86-1	C5H5N	9.25	0.79
quinoline	QUNOLINE		91-22-5		8.63	0.72
styrene	STYRENE		100-42-5	C8H8	8.47	0.4
tetrachloroethylene	PERC	PCE, Perchloroethylene, Tetrachloroethylene, Perchloroethene	127-18-4	C2Cl4	9.32	0.56
tetrahydrofuran	THF	THF	109-99-9	C4H8O	9.41	1.6
thiophene	THIOLE		110-02-1		8.86	0.47
toluene	TOLUENE	Methylbenzene	108-88-3	C7H8	8.82	0.53
trichloroethylene	TCE		79-01-6		9.47	0.5
trimethylamine	TEN	TEN	121-44-8	C6H15N	7.53	0.83
trimethylbenzene, 1,2,3-	123MEBNZ		526-73-8	C9H12	8.42	0.49
trimethylbenzene, 1,2,4-	124MEBNZ		95-63-6	C9H12	8.27	0.43
trimethylbenzene, 1,3,5-	135MEBNZ		108-67-8	C9H12	8.4	0.34
turpentine - crude sulfite	TURPS-CS	Pinenes (85%) + other diisoprenes	8006-64-2	C10H16		1



COMPOUND NAME	Display Name	Synonym(s)	CAS Number <sup>1</sup>	Chemical Formula	Ionization Potential	RF 10.6eV lamp
turpentine - pure gum	TURPS-PG	Pinenes (85%) + other diisoprenes	8006-64-2	C10H16		0.45
vinyl acetate	VNYLACET		108-05-4	C4H6O2	9.19	1.3
vinyl bromide	VBRM	Bromoethylene	593-60-2	C2H3Br	9.8	0.4
vinyl chloride	VCM	Chloroethylene, VCM	75-01-4	C2H3Cl	9.99	1.8
vinylcyclohexane	VYLCYHEX	VCH	695-12-5	C8H14	9.51	0.54
vinylidene chloride	VDC	1,1-DCE, dichloroethene, 1,1-	75-35-4	C2H2Cl2	9.81	0.8
xylene, m-	M-XYLENE	1,3-Dimethylbenzene	108-38-3	C8H10	8.56	0.53
xylene, o-	O-XYLENE	1,2-Dimethylbenzene	95-47-6	C8H10	8.56	0.54
xylene, p-	P-XYLENE	1,4-Dimethylbenzene	106-42-3	C8H10	8.44	0.5

<sup>1</sup> The CAS Number is a unique numerical identifier created and assigned to a chemical substance by the American Chemical Society. All Rights Reserved.

# 11 Flow Chart

## 11.1 Basic Operation

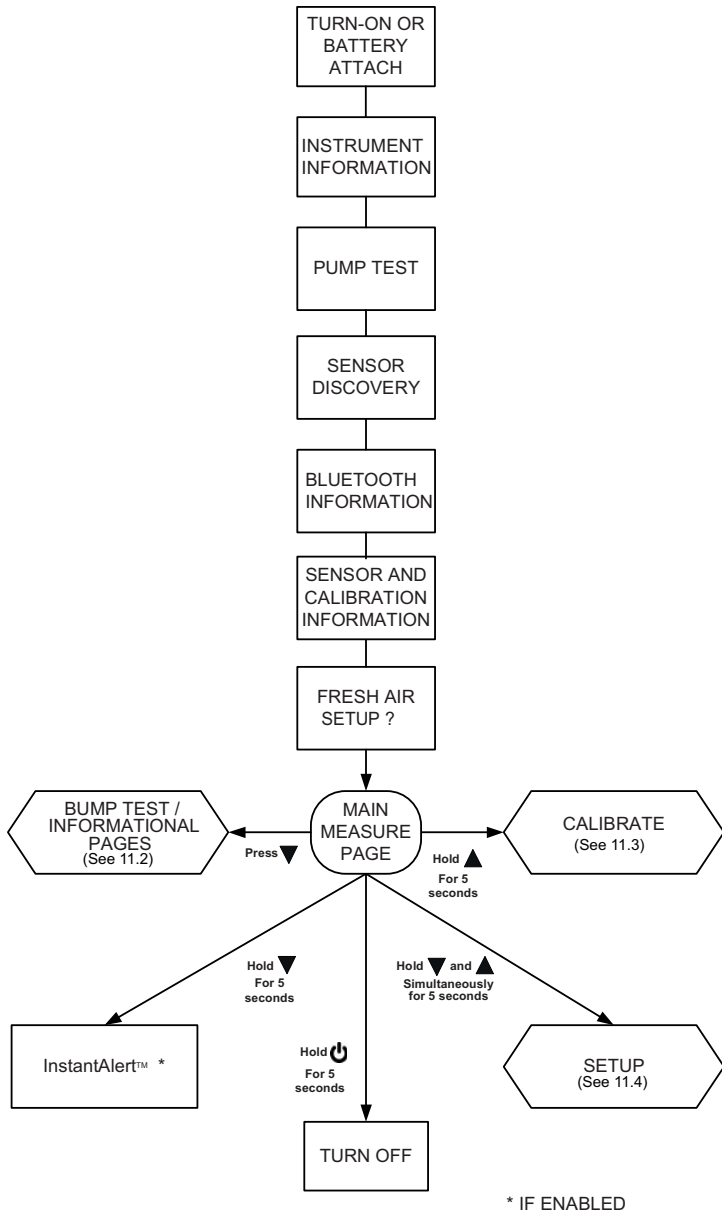

11.2 Bump Test/ Informational Pages

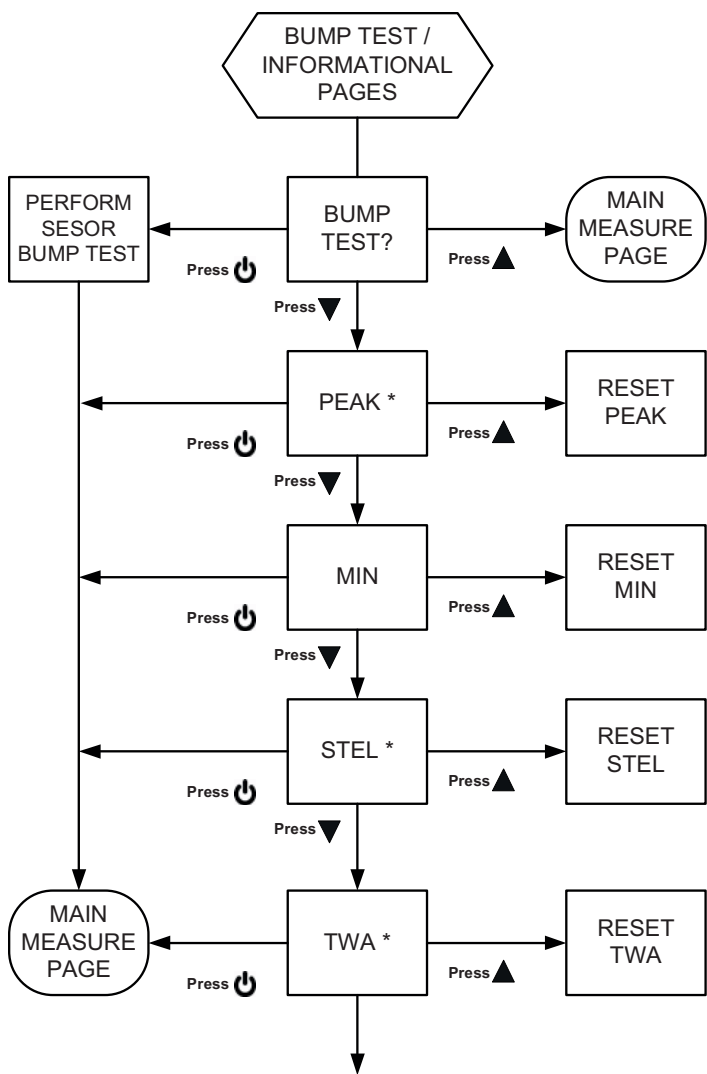

\* IF ENABLED (NOT VALID FOR ALL SENSORS)

# 11 Flow Chart

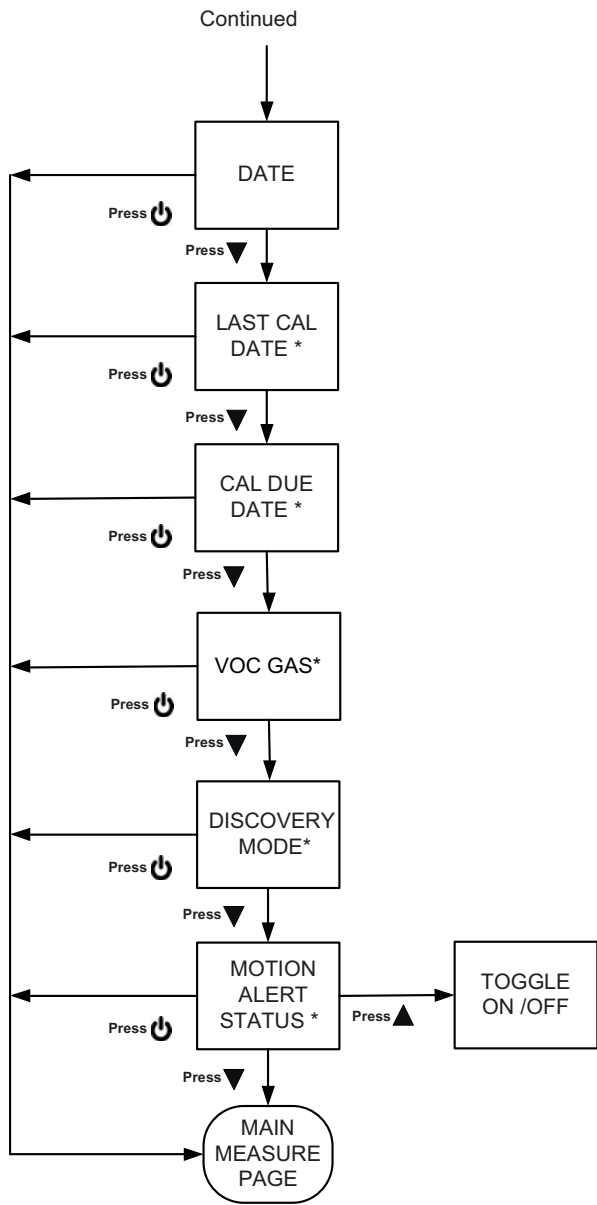

\* IF ENABLED

\*\* IF WIRELESS IS INSTALLED

11.3 Setup

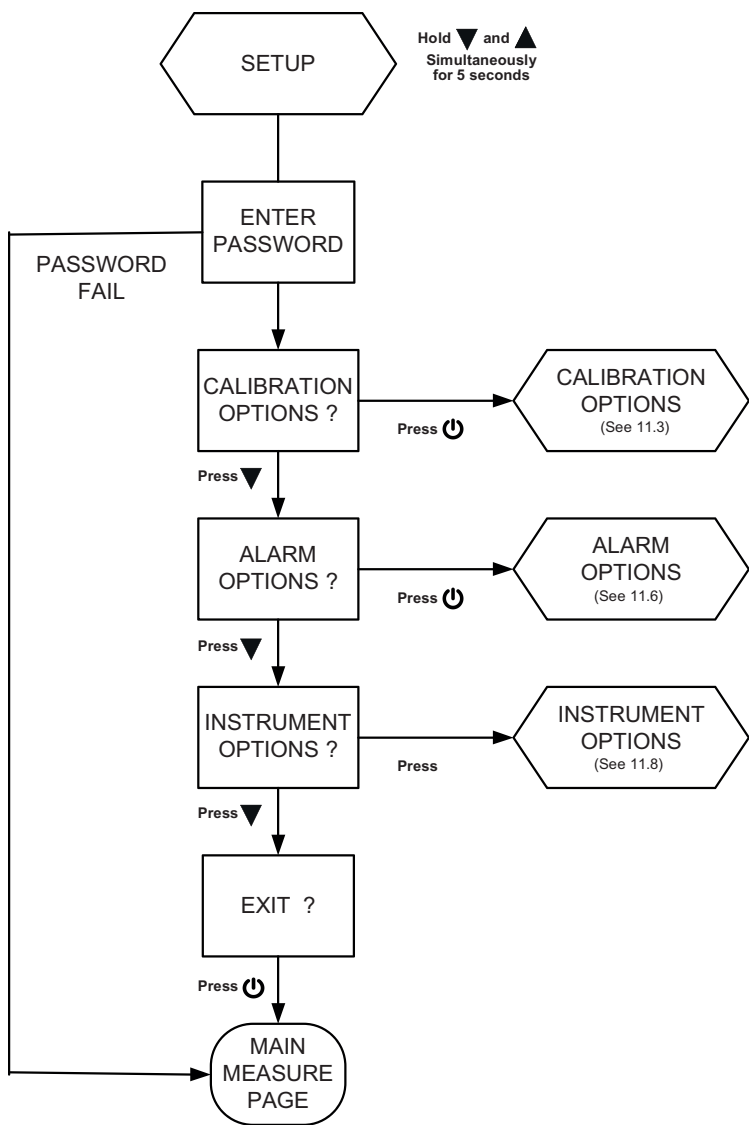

11.4 Calibrations

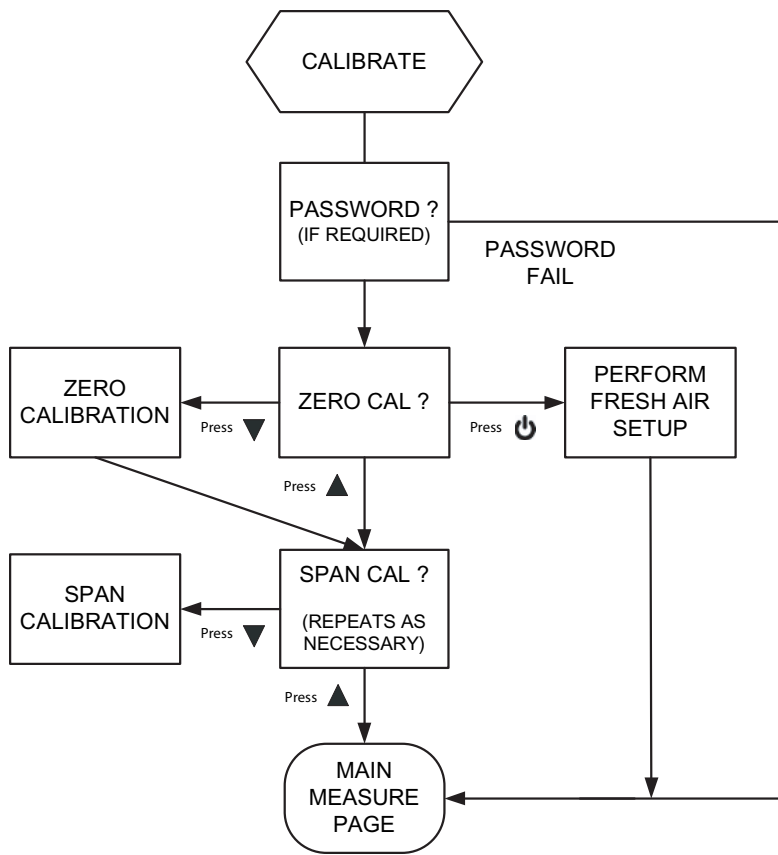

11.5 Calibration Options

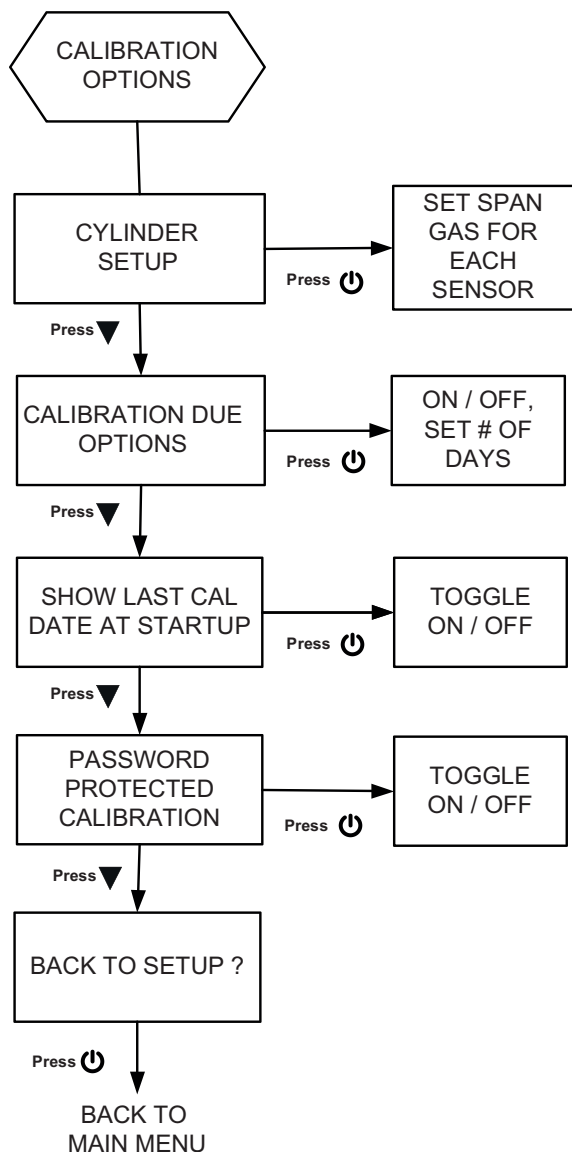

11.6 Alarm Options

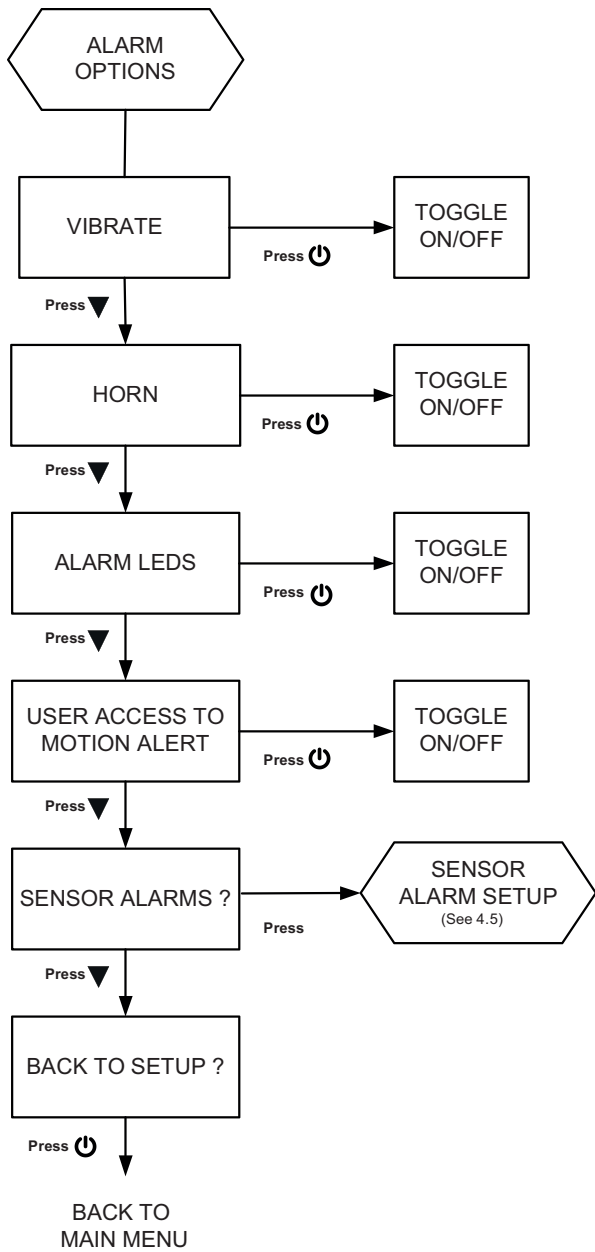



11.7 Sensor Alarm Setup

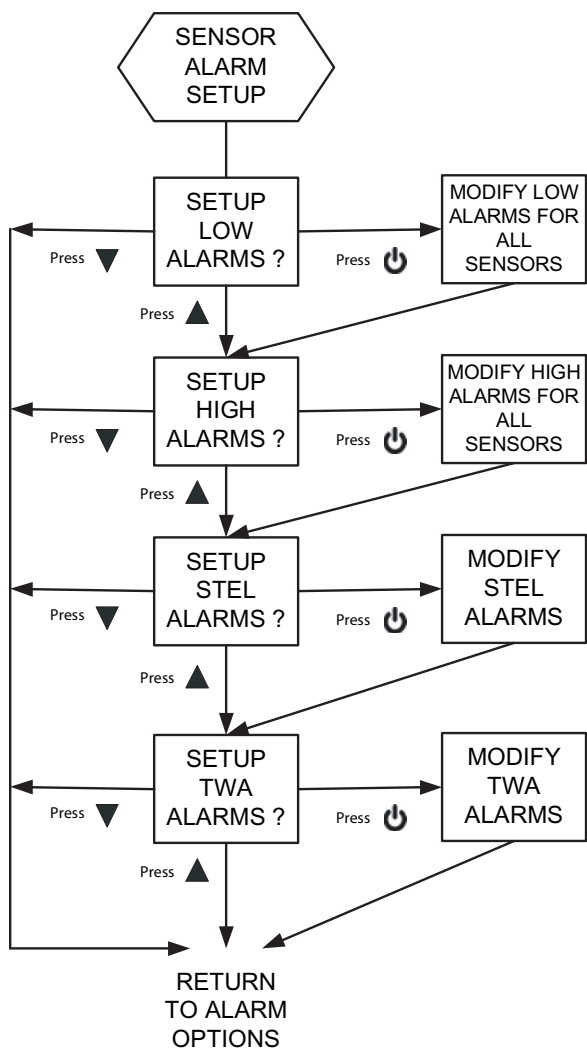

NOTE: STEL AND TWA ARE NOT VALID FOR ALL SENSORS

11.8 Instrument Options

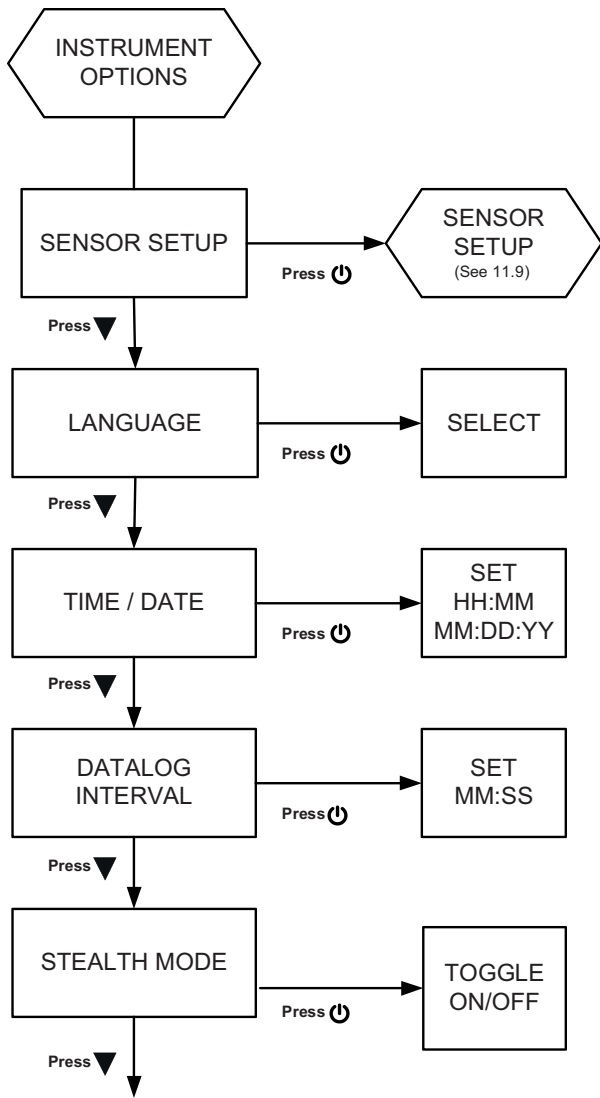

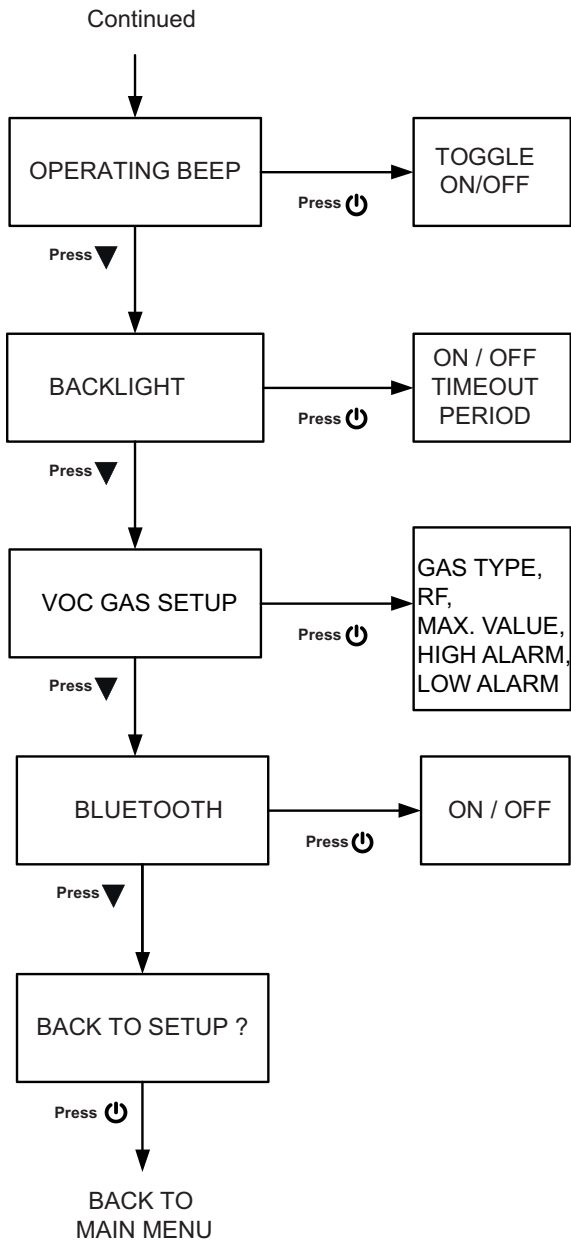

11.9 Sensor Setup

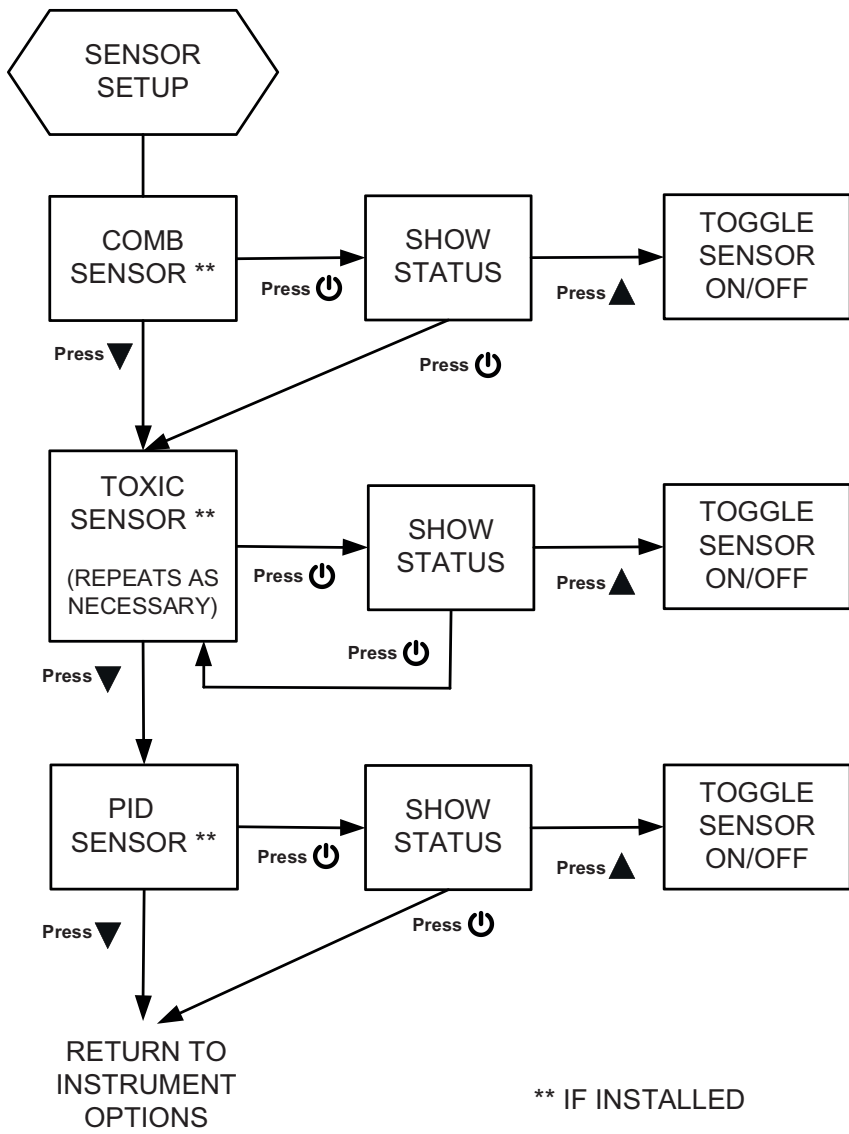

### 11.10 VOC Gas Setup

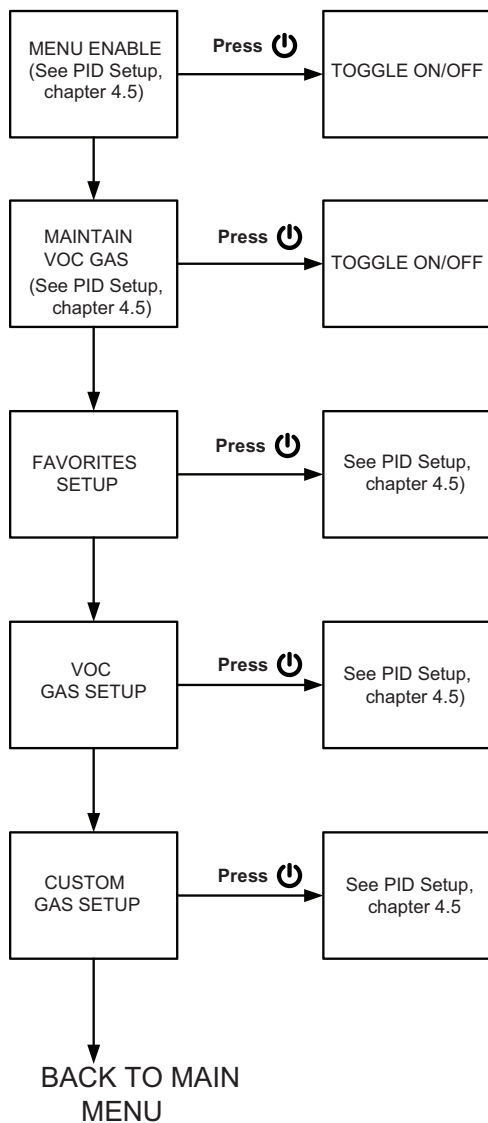

## 12 Changeable Feature Summary

Feature	Initial Setting	Setup Path to Change this Setting	Change with MSA link?	Change via Bluetooth?
Setup Password	672	-	Yes	No
Vibrating Alarm	ON	ALARM OPTIONS	Yes	Yes
Horn Alarm	ON	ALARM OPTIONS	Yes	Yes
LED Alarm	ON	ALARM OPTIONS	Yes	Yes
Safe LED (green)	ON	-	Yes	No
Operating Beep (alarm LEDs & horn)	OFF	INSTRUMENT OPTIONS	Yes	No
Stealth	OFF	INSTRUMENT OPTIONS	No	No
MotionAlert - Access	Allowed	ALARM OPTIONS	No	Yes
MotionAlert	OFF	Use ▼ button from MEASURE page	No	Yes
Sensor Alarm Levels		ALARM OPTIONS / SENSOR ALARM SETUP	Yes	Yes
Enable / Disable High & Low Alarms	Enabled	-	Yes	Yes
Turn Sensors ON / OFF	ON	INSTRUMENT OPTIONS / SENSOR SETUP	Yes	No
Show Peak	ON	-	Yes	No
Show STEL, TWA	ON	-	Yes	No
Cal Cylinder Setup		CAL OPTIONS	Yes	Yes
Show Last Cal Date	ON	CAL OPTIONS	No	No
Show Cal Due	ON	CAL OPTIONS	Yes	No
Cal Password Required	OFF	CAL OPTIONS	No	No
Backlight	Enabled	-	No	Yes
Backlight Duration	10 s	INSTRUMENT OPTIONS	Yes	Yes
Display Contrast	Factory-set	INSTRUMENT OPTIONS	No	No
Language	User-set	INSTRUMENT OPTIONS	No	Yes
Date, Time	User-set	INSTRUMENT OPTIONS	Yes	Yes
Datalog Interval	3 min	INSTRUMENT OPTIONS	Yes	No
Custom Logo Screen	Factory-set	Certified service center	Yes	No
Device S/N	Factory-set	-	No	No
Company Name	Blank	-	Yes	Yes
Dept./User Name	Blank	-	Yes	Yes
VOC RF ON/OFF	ON	INSTRUMENT OPTIONS	Yes	No
Bump Due ON/OFF	OFF	-	Yes	Yes
Bump Interval	1	-	Yes	Yes
Cal Due Interval	30	INSTRUMENT OPTIONS	Yes	Yes