



Series 668B/D Compact Differential Pressure Transmitter

Specifications - Installation and Operating Instructions



668B



668D

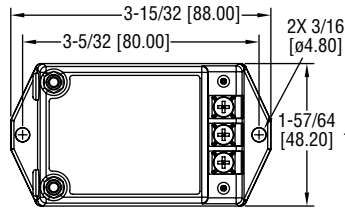

668B

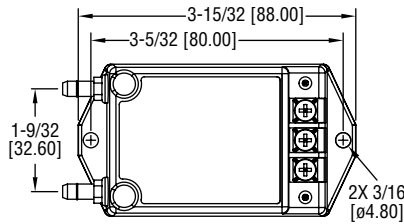
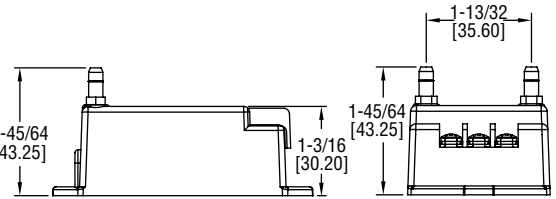

668D

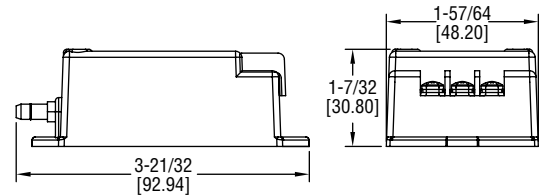

Our low cost Series 668B/D Compact Differential Pressure Transmitter is capable of sensing differential gage pressure with $\pm 0.8\%$ FS accuracy, and converts this pressure difference to a proportional high level analog output for both unidirectional and bi-directional pressure ranges. Transmitters can withstand up to 15 psig overpressure with no damage to the unit. The compact, lightweight design makes installation simple and easy. Units are protected against incorrect wiring, and include a protective terminal cover.

INSTALLATION

Work on electrical installations must only be carried out by electricians who are specifically trained for this purpose.

CAUTION Risk of Shock: Disconnect power supply before making electrical connections. Contact with components carrying hazardous voltage can cause electrical shock and equipment may be damaged.

The Series 668B/D is designed to be used with 3/16" I.D. push-on tubing. The high pressure port and the low pressure port are labeled "+" and "-" respectively. For best results (shortest response times), 3/16" I.D. tubing is suggested for tubing lengths up to 80 feet (25 meters), 1/4" I.D. for tubing lengths up to 250 feet (75 meters) and 3/8" I.D. for tubing up to 720 feet (220 meters).

The table below shows the maximum wire and receiver resistances as a function of supply voltage (See Figure 1).

V _{min}	V _{max}	R _{min}	R _{max}	RL at Supply Voltage (Vs)
12	32	0	1000	RL ≤ 50(Vs-12)

Example: If the Supply Voltage is 24 VDC, $RL \leq 50(24-12) = 600 \Omega$, the load resistance should not exceed 600 Ω .

SPECIFICATIONS

- Service:** Air and non-conductive gases.
- Accuracy:** $\pm 0.8\%$ FS.
- Temperature Limits:** Operating: 0 to 170°F (-18 to 77°C); Storage: -40 to 185°F (-40 to 85°C).
- Pressure Limits:** 15 psig (1.0 bar).
- Thermal Effects:** $\pm 0.03\%$ FS/°F ($\pm 0.054\%$ FS/°C).
- Compensated Range:** From 40 to 170°F (4.4 to 77°C).
- Power Requirements:** 12 to 32 VDC.
- Output Signals:** 4 to 20 mA (2-wire), 0 to 10 VDC (3-wire), or 0 to 5 VDC (3-wire).
- Zero Adjustment:** Accessible under the small terminal cover.
- Electrical Connection:** Terminal strip.
- Process Connection:** 3/16" OD barbed brass for 1/8" ID push-on tubing.
- Enclosure:** Stainless steel and PC+ABS alloy, UL 94 V-0 rated.
- Weight:** 4.0 oz (113 g).
- Agency Approvals:** CE.

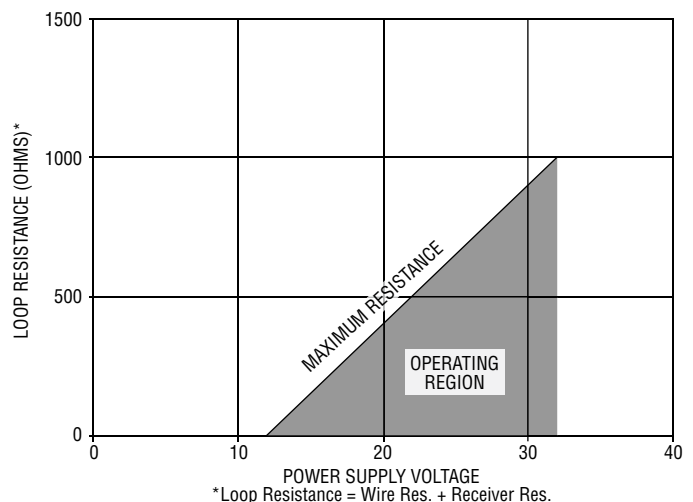

Figure 1

VOLTAGE OUTPUT

The 668B/D has a 0 to 5 or 0 to 10 VDC output in a 3-wire configuration, with three terminals available for wiring. These terminals have the designation "+", "O", and "-" (See Figure 2). The power supply and signal references are commoned on the circuit (See Figure 3), and the 668B/D voltage output can operate from 12 to 32 VDC power supply. The unit is calibrated at the factory with a 24 VDC power supply, 50 K Ω load resistor.

Connect the "+" terminal to the positive terminal of the DC power supply.
Connect the "O" terminal to the positive terminal of the control or pressure monitor.
Connect the "-" terminal as the reference for the power supply and output signal.

CURRENT OUTPUT

The 668B/D current output is a 2-wire loop-powered 4 to 20 mA current output unit and delivers rated current into any external load to 0 to 1000 Ω . These terminals have the designation "+" and "-" (See Figure 2). The current flows into the "+" terminal and returns back to the power supply through the "-" terminal (See Figure 4). The 668B/D current output can operate from 12 to 32 VDC power supply. The unit is calibrated at the factory with a 24 VDC loop supply voltage and a 250 Ω load resistor.

CALIBRATION

The 668B/D transmitter is calibrated in the vertical mounting position at the factory. The zero adjustment is accessible under the terminal cover of the unit in case there is a zero shift when using other positions.

Zero Adjustment

While monitoring the output of the unit with both pressure ports open to atmosphere, the zero may be adjusted by turning the zero adjustment screw.

Voltage Output:

Unidirectional Pressure Ranges: 0 VDC

Bi-directional Pressure Ranges: 2.5 VDC or 5.0 VDC

Current Output:

Unidirectional Pressure Ranges: 4 mA

Bi-directional Pressure Ranges: 12 mA

MAINTENANCE/REPAIR

Upon final installation of the Series 668B/D transmitter no routine maintenance is required. The Series 668B/D transmitter is not field serviceable and should be returned if repair is needed. Field repair should not be attempted and may void warranty.

WARRANTY/RETURN

Refer to "Terms and Conditions of Sales" in our catalog and on our website. Contact customer service to receive a Return Goods Authorization number before shipping the product back for repair. Be sure to include a brief description of the problem plus any additional application notes.

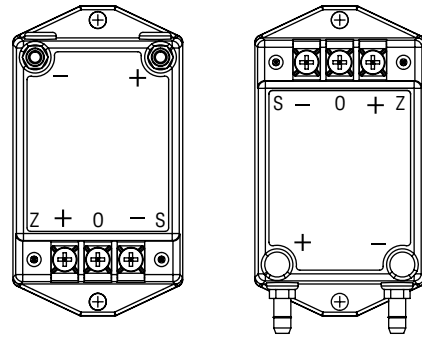

Figure 2

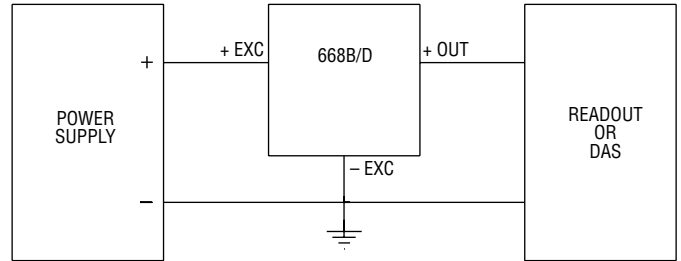

Figure 3

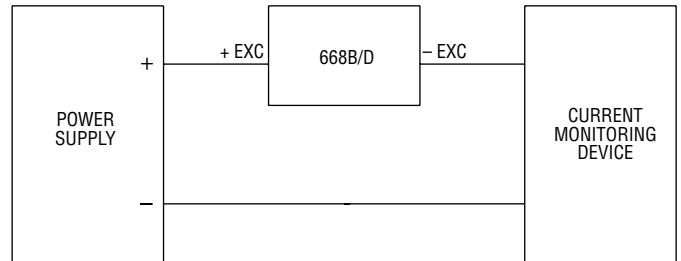

Figure 4