



# Series ULS

Small Tank Ultrasonic Transmitter, Switch and Controller  
Series ULSS, ULSM, ULSL Manual



Dwyer Instruments, Inc.  
102 Indiana Hwy. 212  
(P.O. Box 373)  
Michigan City, IN 46360 (46361) USA  
[www.Dwyer-Inst.com](http://www.Dwyer-Inst.com)

Series ULS is an innovative level sensor family that replaces float, conductance and pressure sensors that fail due to contact with dirty, sticking and scaling media in small (< 4’/1.25m) to medium (<18’/5.5m) tall tanks. Applied in skid, machine, tool and process applications, the general purpose sensors are available with single and multi-function capabilities including measurement, switching and control.

**Features**

- Simple configuration with ULSX-CAL software, ***no more target calibration***
- Adjustable Loop Fail-Safe
- Easy to reverse mA output
- Increased output filtering

**Table of Contents**

Specifications: ..... 3

Dimensions: ..... 4

Safety Precautions: ..... 5

Components: ..... 6

Getting Started: ..... 7

    USB Fob Interface: ..... 7

ULSX-CAL: ..... 8

    Configuration: ..... 9

    Tank Levels & Relay Values: ..... 16

    Write to Unit & Wiring Diagram: ..... 17

Wiring: ..... 18

    Wire Connections: ..... 18

    Switch Inductive Loads: ..... 19

Installation: ..... 20

    Mounting Guide: ..... 20

    Fitting Selection: ..... 21

        Tank Adapter: ..... 21

        Riser: ..... 21

        Flange: ..... 22

        Side Mount Fitting: ..... 22

        Stand Pipe: ..... 23

Advanced Feature: ..... 24

Appendix: ..... 26

    Updating ULSX-CAL Software: ..... 26

    Updating Transmitter Firmware: ..... 27

Troubleshooting: ..... 28

    Factory Defaults: ..... 28

    Solution Table: ..... 29

Maintenance & Repair: ..... 30

**SPECIFICATIONS****Step Two**

Range:	ULSS: 49.2" (1.25m) ULSM: 9.8' (3.0m) ULSL: 18.0' (5.5m)
Accuracy:	ULSS: 0.125" (3mm) ULSM: +/- 0.2% of range ULSL: +/- 0.2% of range
Resolution:	ULSS: 0.019" (0.5mm) ULSM: 0.039" (1mm) ULSL: 0.079" (2mm)
Dead band:	ULSS: 2" (5 cm) ULSM: 4" (10 cm) ULSL: 8" (20 cm)
Beam width:	ULSS: 2" (5cm) dia. ULSM: 2" (5cm) dia. ULSL: 3" (7.6cm)
Configuration:	ULSX-CAL <sup>®</sup> PC Windows USB 2.0
Memory:	Non-volatile
Supply voltage:	12-28 VDC
Consumption:	0.5 W
Loop resistance:	400 Ohms max
Signal output:	4-20 mA, two-wire
Signal invert:	4-20 mA or 20-4 mA
Signal fail-safe:	4 mA, 20 mA, 21 mA, 22 mA or hold last
Contact type:	(4) SPST relays

Contact rating:	60 VA, 1A maximum
Contact fail-safe:	Power loss: Hold last, Power on: Open, close or hold last
Hysteresis:	Selectable
Process temp.:	F: 20° to 140° C: -7° to 60°
Temp. comp.:	Automatic
Ambient temp.:	F: -31° to 140° C: -35° to 60°
Pressure:	MWP = 30 PSI
Enclosure rating:	Type 6P encapsulated, corrosion resistance & submersible (IP68)
Encl. material:	Polycarbonate
Strain relief material:	TPE
Trans. material:	PVDF
Cable jacket material:	Polyurethane
Cable type:	9-conductor, shielded
Cable length:	48" (1.2 m)
Process mount:	ULSS: 1" NPT (1" G) ULSM: 1" NPT (1" G) ULSL: 2" NPT (2" G)
Mount gasket:	FKM
Classification:	General purpose
Compliance:	CE, RoHS

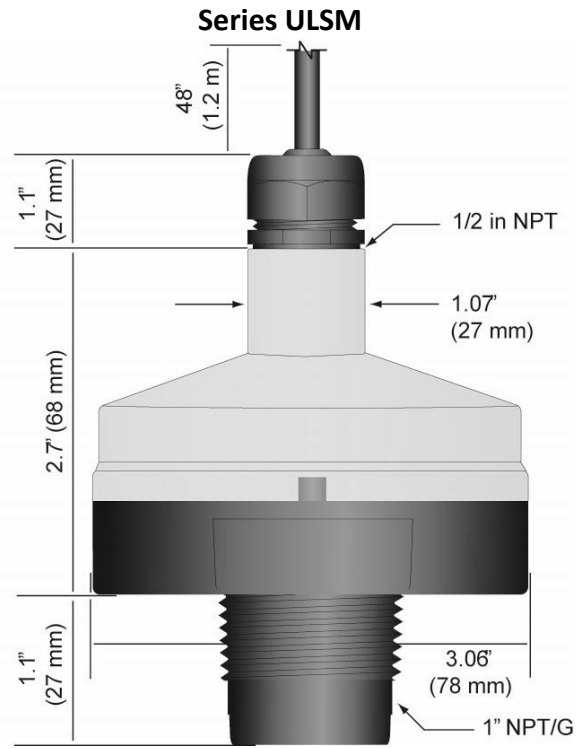
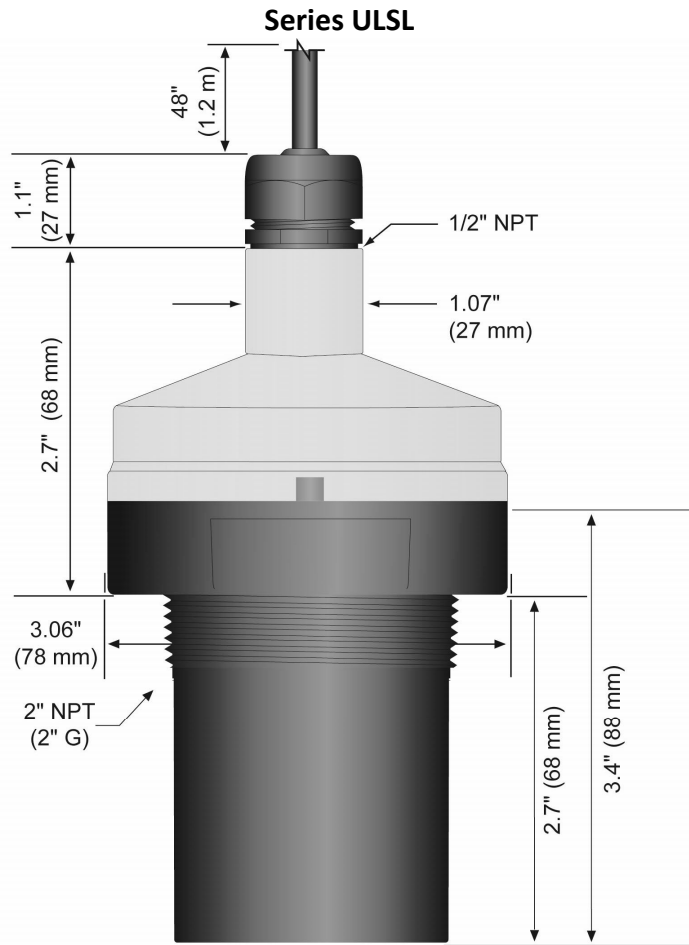

**Series ULSS**

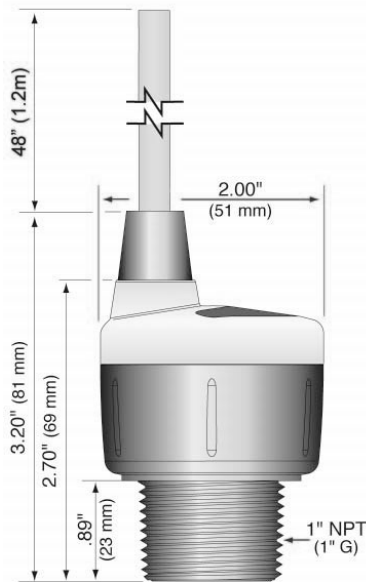

⚠ **About this Manual:** PLEASE READ THE ENTIRE QUICK START PRIOR TO INSTALLING OR USING THIS PRODUCT. This manual includes information on the Series ULS Ultrasonic Level Switch, controller and transmitter from Dwyer Instruments, Inc. Please refer to the part number located on the switch label to verify the exact model configuration, which you have purchased.

⚠ **User's Responsibility for Safety:** Dwyer Instruments, Inc. manufactures a broad range of level sensing technologies. While each of these sensors is designed to operate in a wide variety of applications, it is the user's responsibility to select a sensor model that is appropriate for the application, install it properly, perform tests of the installed system, and maintain all components. The failure to do so could result in property damage or serious injury.

⚠ **Proper Installation and Handling:** Only professional staff should install and/or repair this product. Install the transmitter with the included FKM gasket and never over tighten the transmitter within the fitting. Always check for leaks prior to system start-up.

⚠ **Wiring and Electrical:** A supply voltage of 12 to 28 VDC is used to power the Series ULS. Electrical wiring of the transmitter should be performed in accordance with all applicable national, state, and local codes. **Note:** Series ULS uses latching relays. When power is removed to the sensor, the relays will remain in their last state. Ex: If the relay is energized, when power is removed, the relay will remain in an energized state.

⚠ **Material Compatibility:** The enclosure is made of Polycarbonate (PC). The transducer is made of Polyvinylidene Fluoride (PVDF). Make sure that the model, which you have selected, is chemically compatible with the application media.

⚠ **Enclosure:** While the transmitter housing is liquid-resistant the Series ULS is not designed to be operational when immersed. It should be mounted in such a way that the enclosure and transducer do not come into contact with the application media under normal operational conditions.

#### ⚠ **Safety**

- ⚠ Installation should be done by properly trained staff
- ⚠ Supply voltage should never exceed a maximum of 28 VDC
- ⚠ Make sure the sensor is chemically compatible with your application
- ⚠ Design a fail-safe system that accommodates the possibility of sensor and/or power failure
- ⚠ This sensor should not be used in classified hazardous environments

⚠ **Make a Fail-Safe System:** Design a fail-safe system that accommodates the possibility of transmitter and/or power failure. Dwyer Instruments, Inc. recommends the use of redundant backup systems and alarms in addition to the primary system.

⚠ **Flammable, Explosive or Hazardous Applications:** *Series ULS should not be used within classified hazardous environments.*

⚠ **Warning:** Always use the FKM gasket when installing the Series ULS, and make sure that all electrical wiring of the switch is in accordance with applicable codes.

Series ULS is offered in different models. Depending on the model purchased, you may or may not have been shipped all the components shown below. You do however, need a Series ULS, USB Fob and FKM gasket to configure, install and operate Series ULS.

P/N	Max. Range	Dead Band	Thread	Fob	* Outputs
ULSS-10	4.1' (1.25 m)	2" (5cm)	1" NPT	No Fob	1,2
ULSM-10	9.8' (3.0 m)	4" (10cm)	1" NPT		
ULSL-10	18.0' (5.5 m)	8" (20cm)	2" NPT		

- USB Fob
  - Part# ULS-ACC-USB
- Quick Start Guide
- \*Outputs
  1. 4-20 mA, loop powered output
  2. 4 SPST 60 VA relays

Series ULS is configured through ULSX-CAL, a PC software program. ULSX-CAL is a free download from the Dwyer Instruments, Inc. website. **You must download and install ULSX-CAL prior to plugging in the USB Fob.** Please go to <http://www.Dwyer-Inst.com/software>, click on ULSX-CAL. Please observe the following requirements for the ULSX-CAL software:

ULSX-CAL System Requirements
Windows® 2000, Windows® XP, Windows Vista®, Windows® 7
32 or 64-bit operating system
1 USB 2.0 port
10 mB hard drive space
256 mB RAM
Internet connection

**USB Fob Interface:** The Series ULS communicates with ULSX-CAL through a USB interface (p/n: ULS-ACC-USB) called a Fob. Before plugging your Fob into your computer's USB port, be sure that you have installed ULSX-CAL on your computer.

Connect the red, green, white and black wires from Series ULS into the correct terminals on the Fob. Tighten the screws on the terminals and plug your Fob into the USB port of your computer.

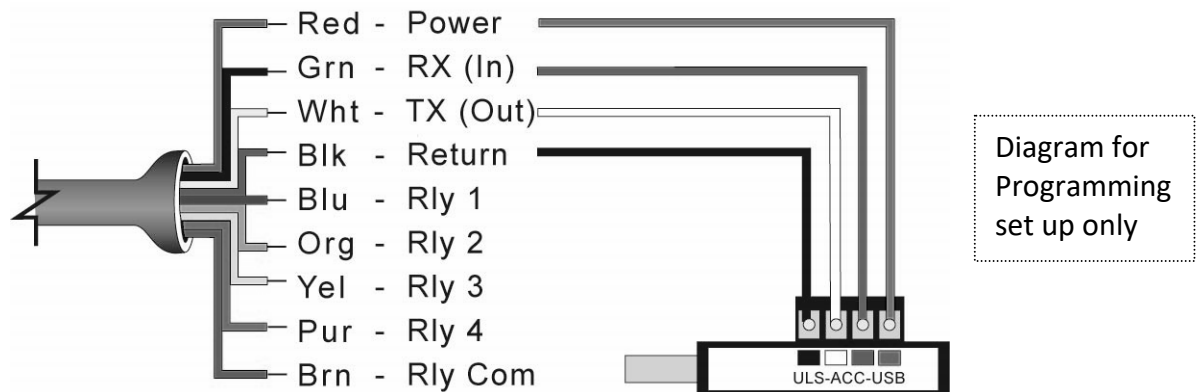

**Wiring identical for all series – Use only the Red, Black, Green and White wires.**

- The maximum cable distance between the computer and Series ULS is 15' (4.6 m). This only applies when configuring the Series ULS.
- Once Series ULS is configured and prior to installation, isolate the white and green wires from active power to prevent a short of the configuration circuit.
- When using the Fob, do not add VDC power. The Fob, when connected to the computer, will provide the required power to the Series ULS.

Windows® is a registered trademark of Microsoft Corporation  
 Windows Vista® is a registered trademark of Microsoft Corporation

With Series ULS connected to your computer, open the ULSX-CAL software by clicking on the ULSX-CAL icon. Follow steps 1-3 to configure the transmitter. Click “Help” in the lower right hand corner and open the help menu of ULSX-CAL for additional instructions on ULSX-CAL. If you need additional assistance using ULSX-CAL, please contact a Dwyer Instruments, Inc. Applications Engineer at (800) 872-9141.

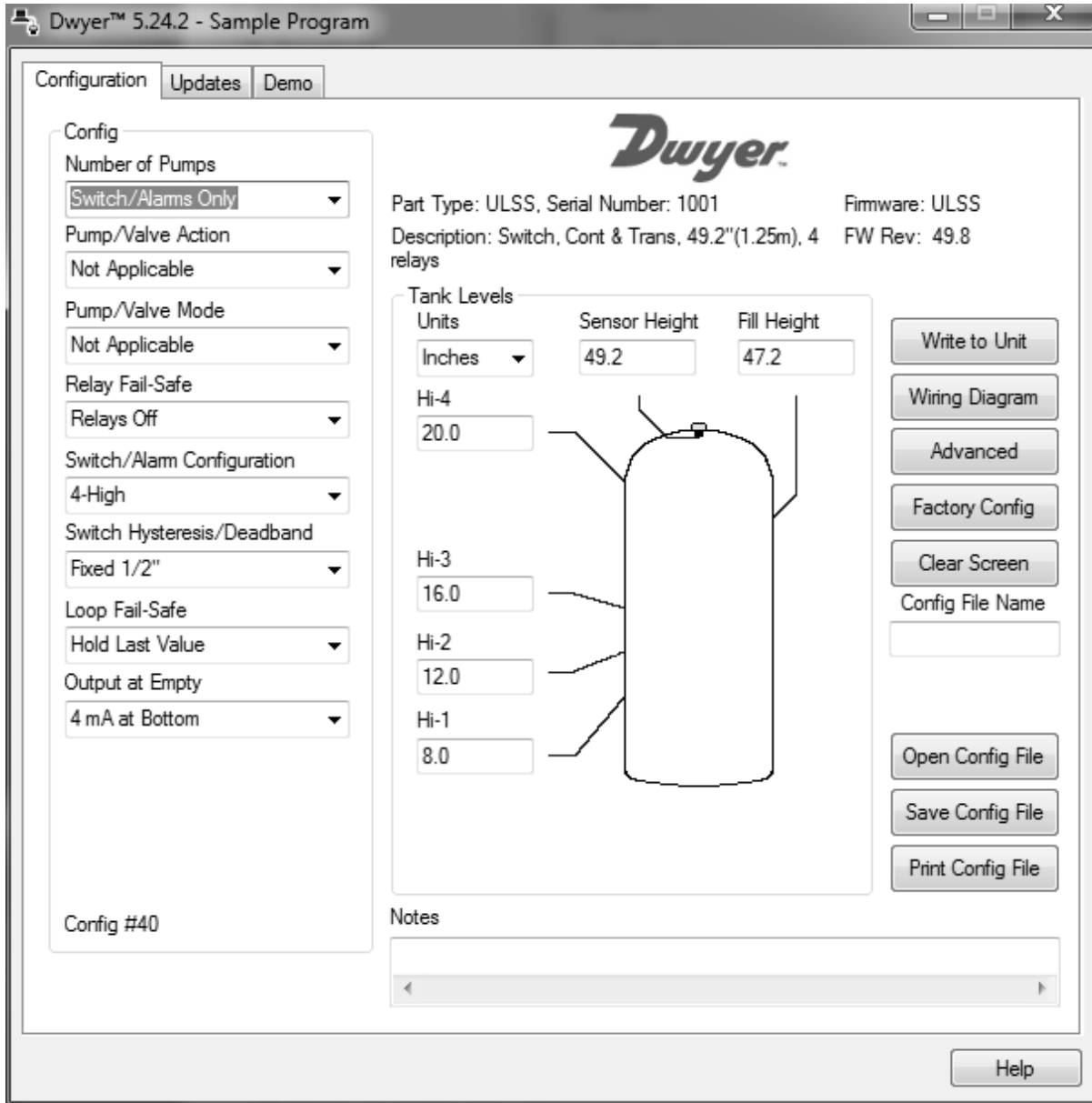

Above Screen Capture is for the Series ULSS.



This section of ULSX-CAL is where you select the application’s configuration settings. Start from the top and work to the bottom, choosing the selections that are applicable to your configuration. **“Not Applicable”** will automatically show when a selection doesn’t apply to your configuration settings, and you may move on. All configuration settings must be selected or have **“Not Applicable”** before you can continue to the next step.

**Note:** Pressing the Clear Screen button will reset the configuration table and allow access to all of the features.

Config

Number of Pumps  
1-Pump/Valve

Pump/Valve Action  
-please select-

Pump/Valve Mode  
Simplex

Relay Fail-Safe  
-please select-

Switch/Alarm Configuration  
-please select-

Switch Hysteresis/Deadband  
-please select-

Loop Fail-Safe  
-please select-

Output at Empty  
-please select-

Continue to select

**Number of Pumps:** This feature allows you to select the number of pumps or valves used with Series ULS. This is the setting that activates the control capabilities of up to two relays. Control relays are often referred to as latching relays.

- **Switch/Alarms Only** – The relays will be standard single point relays (High and/or Low alarms). Relays are non-latching.
- **1- Pump/Valve** – One relay will be configured as a control or latching relay (relay will have a start level and a separate stop level). Use this setting to control one pump or valve for automatic filling or emptying of a tank.
- **2-Pumps/Valves** – Two relays are configured as control or latching relays. Each relay will have a unique start level and a common stop level. Use this setting to control two pumps or valves for automatic filling or emptying of a tank.
- **4-20mA Transmitter Only** – This setting will disengage all of the relays. Use this function if you are not using any relays and using only the 4-20 mA current output.

**Note:** Right click on any menu that you may have questions on to open the help menu.

**Note:** To reset, press the Clear Screen button.

Config

Number of Pumps  
1-Pump/Valve

Pump/Valve Action  
Empties Tank

Pump/Valve Mode  
Simplex

Relay Fail-Safe  
-please select-

Switch/Alarm Configuration  
-please select-

Switch Hysteresis/Deadband  
-please select-

Loop Fail-Safe  
-please select-

Output at Empty  
-please select-

Continue to select

**Pump/Valve Action:** This feature allows you to select if the pumps or valves will be used to automatically fill or empty the tank. For 2-Pump/Valve mode, both devices must be the same (automatic fill or empty). You cannot set one relay for fill and the other for empty.

- **Empties Tank** – Will set relay(s) to automatically empty a tank. Start level will be above the Stop level for each relay.
- **Fills Tank** – Will set relay(s) to automatically fill a tank. Start level will be below the Stop level for each relay.
- **Not Applicable** – Appears when this function is not available (such as when **Switch/Alarms Only** or **4-20mA Transmitters Only** are selected).

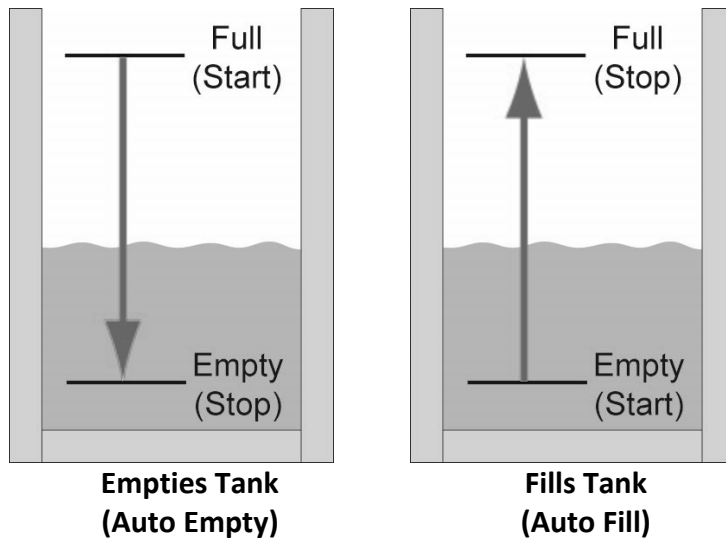

**Note:** Right click on any menu that you may have questions on to open the help menu.

**Note:** To reset, press the Clear Screen button.

Config

Number of Pumps  
1-Pump/Valve

Pump/Valve Action  
Empties Tank

Pump/Valve Mode  
Simplex

Relay Fail-Safe  
-please select-

Switch/Alarm Configuration  
-please select-

Switch Hysteresis/Deadband  
-please select-

Loop Fail-Safe  
-please select-

Output at Empty  
-please select-

Continue to select

**Pump/Valve Mode:** This feature allows you to select the mode for a control or latching relay. Pump/Valve mode is not active for Switch/Alarms Only or 4-20 mA Transmitter Only.

- **Simplex** – Allows for the relay to be used as an automatic fill or empty. This is the default and only configuration when **1-Pump/Valve** is selected.

- **Simplex used to Empty Tank (example)**

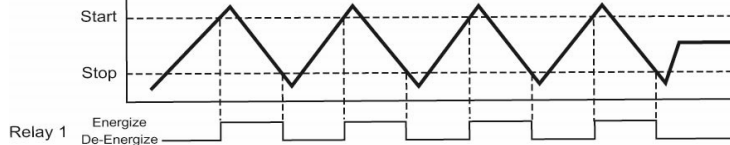

- **Lead/Lag** – Allows for the two relays to have unique start levels and a common stop level. The first relay will be identified as the lead relay and the second relay as the lag. Each time the lead level is reached, the first relay will always start. The lag relay will only start when the lag level is reached. All relays will stop at the common off level.

- **Lead/Lag used to Empty Tank (example)**

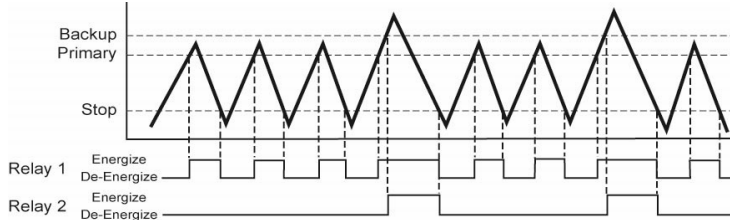

- **Duplex** - Allows for the two relays to have two different start levels, a common stop level and will alternate the relays when the first start level is reached. The two relays will alternate each time the lead level is reached and the remaining relay will start when the lag level is reached. All relays will stop at the common off level.

- **Duplex used to Empty Tank (example)**

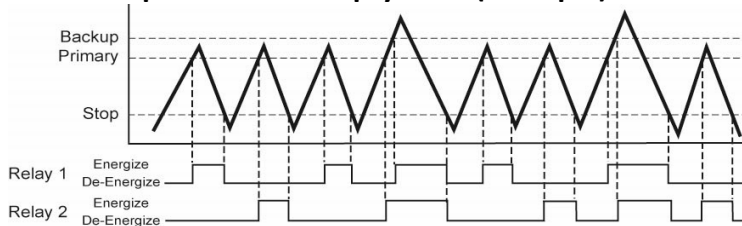

- **Not Applicable** – Appears when this function is not available (such as when **Switch/Alarms Only** or **4-20mA Transmitters Only** are selected).

**Note:** Right click on any menu that you may have questions on to open the help menu.

**Note:** To reset, press the Clear Screen button.

Config

Number of Pumps  
1-Pump/Valve ▼

Pump/Valve Action  
Empties Tank ▼

Pump/Valve Mode  
Simplex ▼

Relay Fail-Safe   
Pumps/Valves Off ▼

Switch/Alarm Configuration  
-please select- ▼

Switch Hysteresis/Deadband  
-please select- ▼

Loop Fail-Safe  
-please select- ▼

Output at Empty  
-please select- ▼

Continue to select

**Relay Fail-Safe:** This feature allows you to select the fail-safe state for the relays. When the sensor regains signal, the output current will revert back to the current level condition.

- **Relays Off** - The relays will revert to the OFF state. Appears when **Switch/Alarms Only** is selected.
- **Relays On** - The relays will revert to the ON state. Appears when **Switch/Alarms Only** is selected.
- **Hold State** - The relay(s) will remain in the same state as the last echo detected. When the sensor regains signal, the relays will revert to the level when the signal was regain.
- **Pump/Valves Off** - The relays will revert to the OFF state. Appears when **1-Pump/Valve** or **2-Pumps/Valves** are selected.
- **Pump/Valves On** - The relays will revert to the ON state. Appears when **1-Pump/Valve** or **2-Pumps/Valves** are selected.
- **Not Applicable** – Appears when this function is not available (such as when **Transmitters Only** are selected).

**Note:** Right click on any menu that you may have questions on to open the help menu.

**Note:** To reset, press the Clear Screen button.

Config

Number of Pumps  
1-Pump/Valve

Pump/Valve Action  
Empties Tank

Pump/Valve Mode  
Simplex

Relay Fail-Safe  
Pumps/Valves Off

Switch/Alarm Configuration 

Switch Hysteresis/Deadband  
-please select-

Loop Fail-Safe  
-please select-

Output at Empty  
-please select-

Finish Selections

**Switch/Alarm Configuration:** This feature allows you to select the operation for the switches / alarms (used as a high or low alarm). This setting adjusts the number of available relays based upon the previous settings.

- **No Alarm** – Turns off all of the remaining relays.
- **High Alarm Options** – Set from 1 to 4 High Alarms (**1-High, 2-High, 3-High, 4-High**).
- **Low Alarm Options** – Set from 1 to 4 Low Alarms (**1-Low, 2-Low, 3-Low, 4-Low**).
- **Combination Alarms** – Set a combination of High and Low Alarms (**1-Low 1-High, 1-Low 2-High, 2-Low 1-High, 2-Low 2-High, 1-Low 3-High, 3-Low 1-High**).
- **Not Applicable** – Appears when this function is not available (such as when **Transmitters Only** is selected).

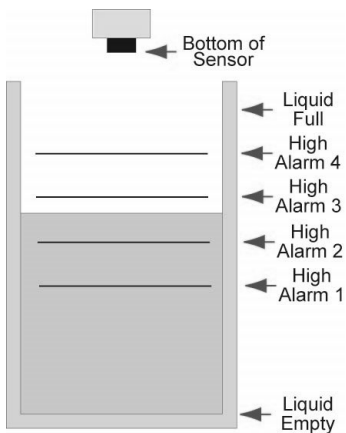

**High Alarm Options  
(4 High)**

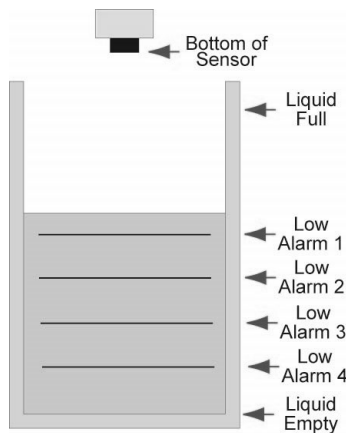

**Low Alarms Options  
(4 Low)**

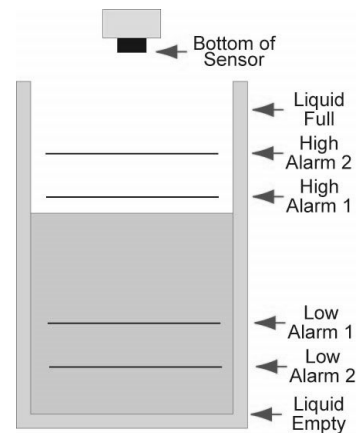

**Combination Alarms  
(2 High and 2 Low)**

**Note:** Right click on any menu that you may have questions on to open the help menu.

**Note:** To reset, press the Clear Screen button.

Config

Number of Pumps  
1-Pump/Valve

Pump/Valve Action  
Empties Tank

Pump/Valve Mode  
Simplex

Relay Fail-Safe  
Pumps/Valves Off

Switch/Alarm Configuration  
1-Low, 1-High

Switch Hysteresis/Deadband  
Fixed 1/2"

Loop Fail-Safe  
-please select-

Output at Empty  
-please select-

Finish Selections

**Switch Hysteresis/Dead band:** This feature allows you to select a hysteresis or dead band for the remaining high and/or low alarms.

- **Options for Hysteresis/Dead band – No Hysteresis, ¼", ½", 1", 2", ½ cm, 1cm, 2 cm, 5 cm or Not Applicable.**
- **High Alarms** – Relay activates above set point. Relay will deactivate when level goes below the set point plus the value of the hysteresis.
- **Low Alarms** – Relay activates below set point. Relay will deactivate when level goes above the set point plus the value of the hysteresis.

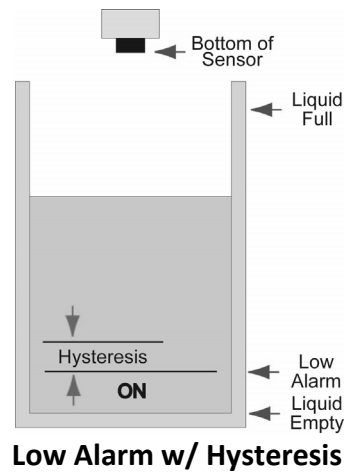
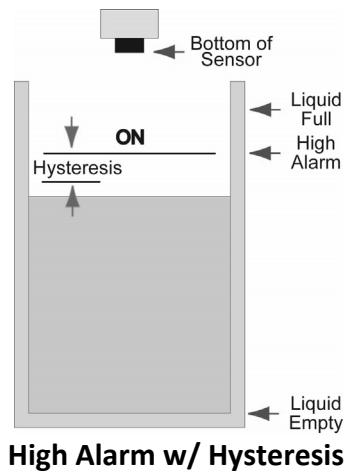

**Note:** Right click on any menu that you may have questions on to open the help menu.

**Note:** To reset, press the Clear Screen button.

Config

Number of Pumps  
1-Pump/Valve

Pump/Valve Action  
Empties Tank

Pump/Valve Mode  
Simplex

Relay Fail-Safe  
Pumps/Valves Off

Switch/Alarm Configuration  
1-Low, 1-High

Switch Hysteresis/Deadband  
Fixed 1/2"

Loop Fail-Safe  
Overfill (21 mA)

Output at Empty  
4 mA at Bottom

Config #9

**Loop Fail-Safe:** This feature allows you to select the fail-safe current output if the sensor fails to detect a return signal. When the sensor regains signal, the output current will revert back to the current level condition.

- **Hold Last Value** - The output will remain in the same state as the last echo detected. Example: If the output was 6.7 mA just prior to the lost signal, the device will continue to output 6.7 mA. Sensor will indicate the level when signal was regain.
- **Empty** - The output will revert to the current value for an empty condition. When **"4 mA at Bottom"** is selected, the sensor will output 4 mA when a fail-safe condition occurs. If **"20 mA at Bottom"** is selected, the sensor will output 20 mA when a fail-safe condition occurs.
- **Full** - The output will revert to the current value for a full condition. When **"4 mA at Bottom"** is selected, the sensor will output 20 mA when a fail-safe condition occurs. If **"20 mA at Bottom"** is selected, the sensor will output 4 mA when a fail-safe condition occurs.
- **Overfill (21 mA)** - The output current will go to 21 mA when the return signal is lost.
- **Overfill (22 mA)** - The output current will go to 22 mA when the return signal is lost.

**Output at Empty:** This feature allows you to select the orientation of the 4 to 20 mA output (4 to 20 mA or 20 to 4 mA). Choose which output setting best fits the application. Typical installations are set with **4 mA at Bottom**. This will not affect the performance of the sensor other than the output of the Series ULS. ULSX-CAL's factory default is 4 mA at bottom and 20 mA at top. *When connecting your sensor to a display, you must account for your output settings.*

- **4 mA at Bottom** - The output current will be 4 mA when the sensor measures an empty tank and 20 mA when the sensor measures a full tank.
- **20 mA at Bottom** - The output current will be 20 mA when the sensor measures an empty tank and 4 mA when the sensor measures a full tank.

**Note:** Right click on any menu that you may have questions on to open the help menu.

**Note:** To reset, press the Clear Screen button.

**ULSX-CAL - Tank Levels:** This section of ULSX-CAL is where you enter application measurement values. This applies to all versions of the Series ULS. You must enter the Sensor Height and Fill Height values.

- For the Series ULSS, ULSM and ULSL, the Sensor Height and Fill Height values determine the operational range for the 4-20 mA output.

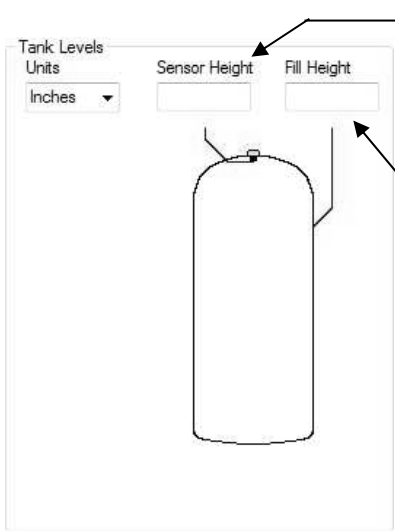

**Sensor Height:** Distance from the bottom of the tank to the bottom of the transducer.

**Fill Height:** Distance from the bottom of the tank to the maximum liquid height.

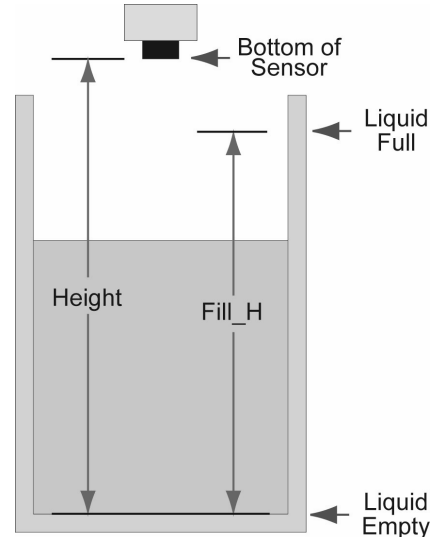

**ULSX-CAL - Relay Values: (Series ULSS, ULSM and ULSL only):** This section of ULSX-CAL is where you enter the operational values for relays. You must enter values within all of the fields shown. The value fields shown are based upon the configuration of the Series ULS. All values must be in the units of operation selected above and are based upon units of liquid. All relay values must be greater than Liquid Empty (0) and less than Liquid Full (Fill Height).

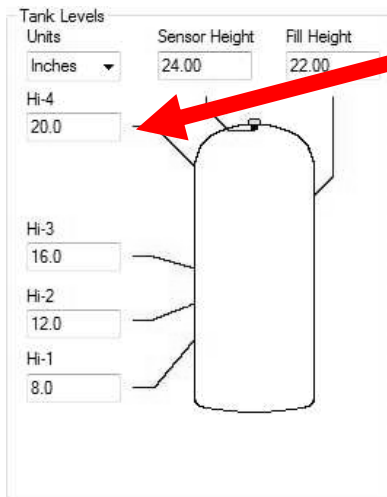

**Example:** This sample shows 4 High Level Alarms. As the level increases from the bottom –up, each alarm will activate at 4” increments.

**Example:** This sample shows a 2-Pump Lead/Lag operation with a High and Low alarm. The pumps will automatically empty the tank and the alarms will activate if the level gets too high or low.

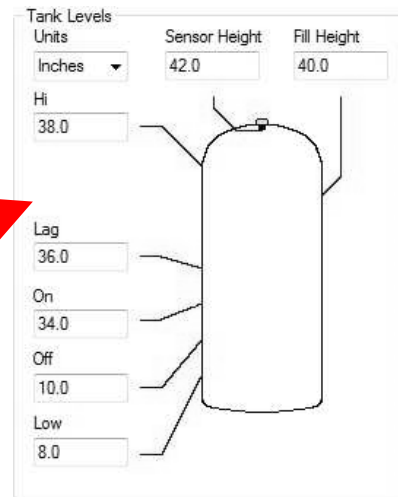



After you have entered configurations and tank values, click **“Write to Unit”** and send the configuration to your Series ULS. Now use ULSX-CAL’s file management features to save your configuration by clicking **“Save Config File”** and print your wiring diagram by clicking **“Wiring Diagram.”**

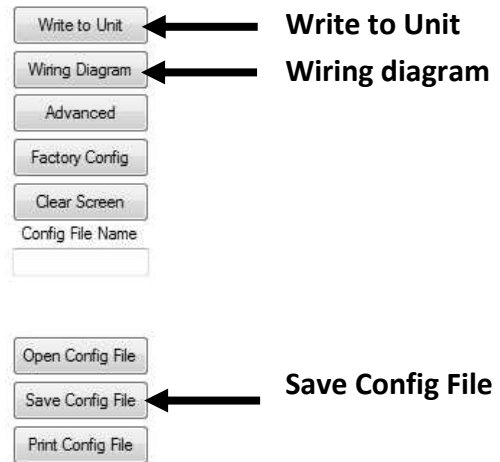

**Wiring Diagram - Sample**

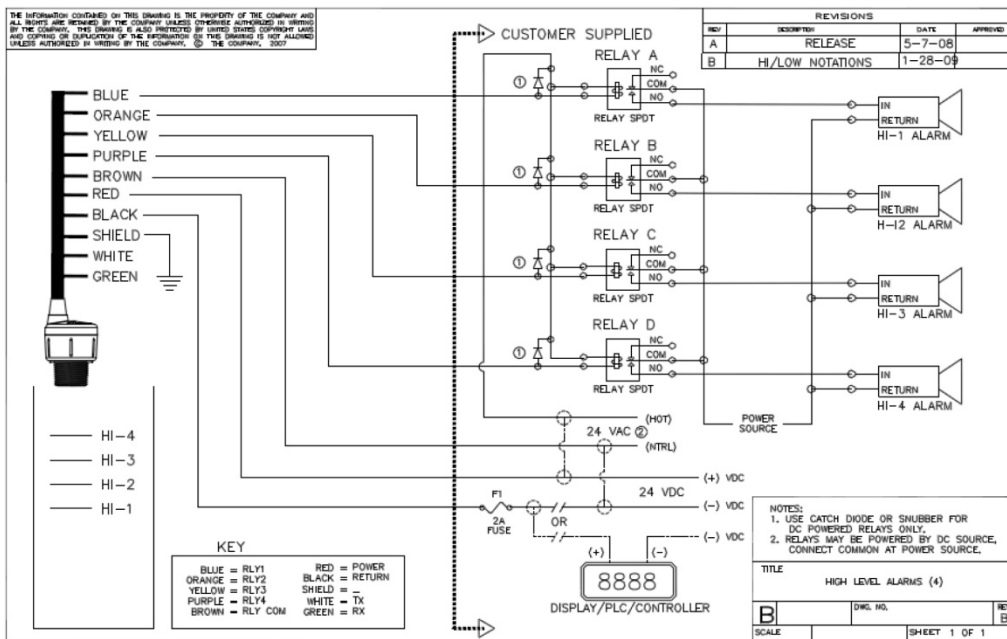

**Diagram will change based upon the configuration of the Series ULS, use ULSX-CAL to view appropriate wiring diagram.**

**Wiring Series ULS:** Once Series ULS has been installed, follow the Wiring Diagram provided by the ULSX-CAL software. A typical wiring diagram is shown above. Dwyer Instruments, Inc. recommends using a qualified licensed electrician to wire Series ULS and your application’s components.

- ⚠️ Configure your Series ULS with ULSX-CAL and use the wiring diagram button to view the appropriate diagram. Each configuration will have its own unique diagram. The diagram above is only a sample and should not be used as a wiring diagram.
- ⚠️ Always use stepper relays between the sensor and external loads. For DC circuits use a catch diode such as 1N4148, shown on the wiring diagram shown above and supplied by ULSX-CAL.
- ⚠️ **Once Series ULS is configured, isolate the white and green wires from active power to prevent a short of the configuration circuit.**

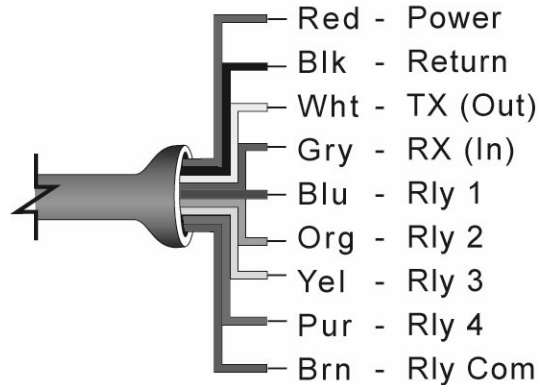
**Wire Connections:**

**Red & Black:** Red and Black leads are for connection to a 12-28 VDC power supply or to a 4-20 mA loop power source (Series ULSS, ULSM & ULSL only). The red and black wires can be extended up to 1,000 feet using a 22 gauge or larger wire, however do not extend the green and white wires.

**White & Green:** White and Green leads are reserved for use with ULSX-CAL and should not be connected during usage in the application. These wires should not be connected to ULSX-CAL while power is supplied from any source other than the ULS-ACC-USB Fob. The maximum cable distance between the computer and Series ULS is 15'.

***Never allow the white or green wires to touch any power supply.***

**Blue, Orange, Yellow, Purple & Brown:** Blue, Orange, Yellow & Purple wires are the relay contacts (normally open) from each of the relays respectively. The Brown wire is the common for all the relays. Relay selection is determined by the configuration in ULSX-CAL. **Note:** *Series ULS uses latching relays. When power is removed to the sensor, the relays will remain in their last state. Ex: If the relay is energized, when power is removed, the relay will remain in an energized state.*

**General notes for electrical connections, usage and safety:**

- Where personal safety or significant property damage can occur due to a spill, the installation must have a redundant backup safety system installed.
- Wiring should always be completed by a licensed electrician.
- Supply voltage should never exceed 28 VDC.
- Always use stepper relays between the sensor and external loads. For DC circuits use a catch diode such as 1N4148, shown on previous page.
- Protect the sensor from excessive electrical spikes by isolating the power, whenever possible.
- The sensor materials must be chemically compatible with the liquids to be measured.
- Design a fail-safe system for possible sensor and/or power failure.
- Never use the sensor in environments classified as **Hazardous**.

**Switching Inductive Loads:** The use of suppressors (snubbers) is strongly recommended when switching inductive loads to prevent disrupting the microprocessor's operation. The suppressors also prolong the life of the relay contacts. Suppression can be obtained with a catch diode for DC circuits and a resistor-capacitor (RC) for AC circuits.

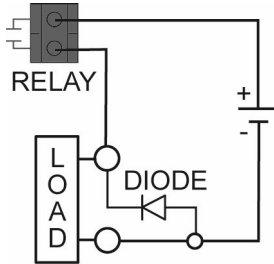

#### Catch Diode

- Always use stepper relays between the sensor and external loads. For DC circuits use a catch diode such as 1N4148, shown on left.

Refer to the following circuits for RC network assembly and installation:

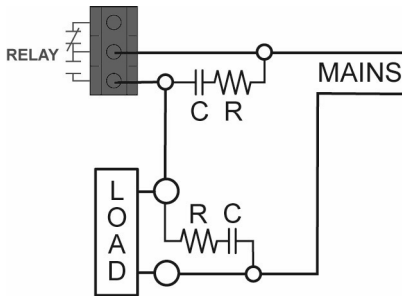

#### Choose R and C as follows:

- R: 0.5 to 1 Ohms for each volt across the contacts
- C: 0.5 to 1  $\mu\text{F}$  for each amp through closed contacts

#### Notes:

1. Use capacitors rated for 250 VAC.
2. RC networks may affect load release time of solenoid loads. Check to confirm proper operation.
3. Install the RC network at the meters relay screw terminals. An RC network may also be installed across the load. Experiment for best results.

**Voltage Output:** Series ULS can be used as a 0 to 5 or 0 to 10 VDC output device. A resistor will need to be added to the circuit to enable a voltage output (refer to the wiring diagram below).

- 0-5 VDC output
  - Add a 250 Ohm resistor
  - Actual output will be 0.8 to 5 VDC
- 0-10 VDC output
  - Add a 500 Ohm resistor
  - Actual output will be 2 to 10 VDC

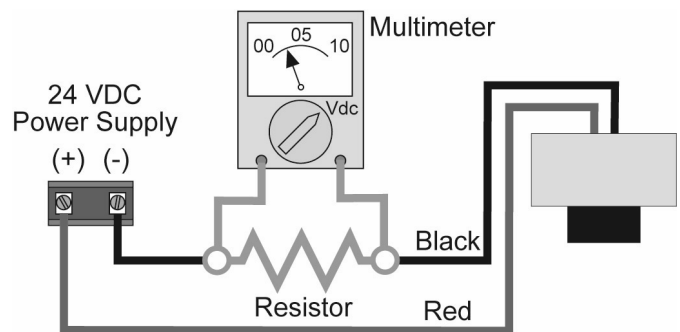

When using ULSX-CAL, under **Number of Pumps**, select **4-20 mA Transmitter Only** to simplify the configuration in ULSX-CAL.

The Series ULS should always be mounted perpendicular to the liquid surface and installed using the provided FKM mounting gasket. Make sure that the fitting and transmitter threads are not damaged or worn. Always *hand-tighten* the transmitter within the fitting. Perform an installed leak test under normal process conditions prior to system start up. **Note:** *The preferred mounting fitting for the Series ULSS & ULSM is the ULS-ACC-121 (2" thread x 1" thread) reducer bushing.*

**Mounting Guide**

1. Do not mount at an angle
2. Liquid should never enter the dead band
3. Side Wall:
  - a. Mount at least 2" from the side wall
  - b. For Series ULSL - mount at least 3" from the side wall
4. Do not mount where obstacles will intrude on sensor's beam width
  - a. See Specifications, Step Two
5. Do not mount in a vacuum
6. Avoid mounting in the center of a dome top tank.
7. In cone bottom tank, position the sensor over the deepest part of the tank.

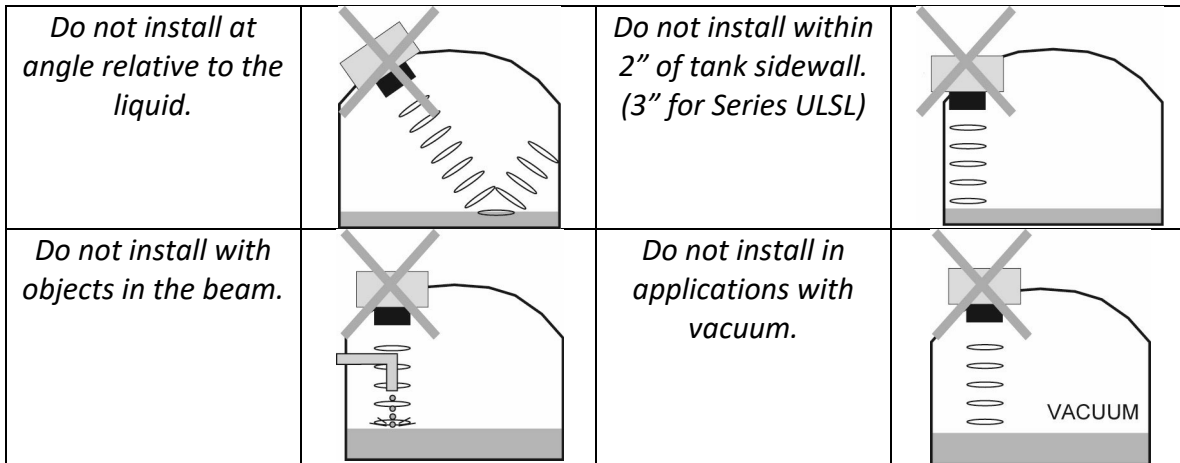

**Installation in existing fittings:** If the existing fitting is larger than the threads of the Series ULS, select a reducer bushing such as the ULS-ACC-121 (2" thread x 1" thread) or ULS-ACC-131 (3" thread x 2" thread).

**Metal Tanks (Series ULSS & ULSM):** Dwyer Instruments, Inc. ultrasonic transmitters have been optimized for use in non-metallic fittings.

1. For best performance, avoid the use of metallic fittings.
  - a. Use a plastic 2" x 1" reducer bushing, such as the ULS-ACC-121 or a plastic 1" flange, such as the ULS-ACC-312 for metallic tanks.
2. While installations directly into a 1" metal fitting are not recommended, acceptable results may be obtained if the 1" fitting is a half coupling in form and the outer diameter of the coupling is tightly wrapped in vinyl tape to dampen vibrations.

**Fitting Selection:** Check the part number to determine the required fitting mount size and thread type. Series ULS is commonly installed in tank adapters, flanges, brackets or standpipes. Note: Always include the gasket when installing the Series ULS.

1. **Tank Adapter:** Select a tank adapter fitting, such as the ULS-ACC-410 for the Series ULSS & ULSM or the ULS-ACC-420 for the Series ULSL.
  - a. *For best results, select a 2" tank adapter and add a reducer bushing such as the ULS-ACC-121, thread x thread, reducer bushing.*
  - b. Avoid tank adapter (thread x thread) styles and/or pipe stops forward of the installed transducer.
  - c. Always mount the tank adapter so the majority of fitting is outside the tank.
    - i. Never mount the tank adapter upside down or the bulk of the material is inside the tank.

**2" Tank Adapter  
Socket x Thread  
(ULS-ACC-420)**



**Tank Adapter (ULS-ACC-420)  
w/ 2"x 1" Reducer Bushing  
(ULS-ACC-121)**



**Tank Adapter  
Thread x Thread**



***Do not use thread x thread***

2. **Riser:** Installations with tall, narrow risers can impede the acoustic signal.
  - a. **Series ULSL:** 2" (5 cm) diameter risers should be no taller than 4" (10 cm). Larger diameter risers should be no taller than 12" (30.5 cm).
  - b. **Series ULSS & ULSM:**

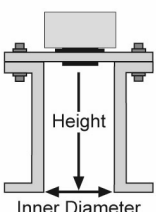
	Riser Specifications	
	Inner Diameter	Maximum Height
2" (5 cm)	3" (7.6 cm)	
4" (10 cm)	8" (20 cm)	
6" (15 cm)	12" (30 cm)	

**Note:** Do not exceed the dimensions listed above

3. **Flange (Series ULSS & ULSM):** If installing on a flange, select a flange with a thread that is above the plane of the flange, such as the ULS-ACC-312.
  - a. *The Series ULSL works well with flange installations.*
  - b. Avoid the use of blind flanges with tapped threads or flanges where the threads are even with the plane of the flange, such as the Banjo 1" Poly ANSI Flange (series AF100).
  - c. Use a flange with a 2" thread and add a 2" to 1" reducer bushing to complete the installation.

**2" Flange w/  
thread out of plane  
(ULS-ACC-312)**



**1" Flange w/  
thread in plane**



**2" Flange w/  
reducer bushing  
(ULS-ACC-121)**



**Do not use thread in plane**

4. **Side Mount Bracket:** For installations in open tanks and sumps, use the ULS-ACC-510 or ULS-ACC-520 side mount bracket.
  - a. For the Series ULSS & ULSM, order the ULS-ACC-510, which includes a 2" x 1" Reducer Bushing.
  - b. For the Series ULSL, order the ULS-ACC-520 side mount bracket.

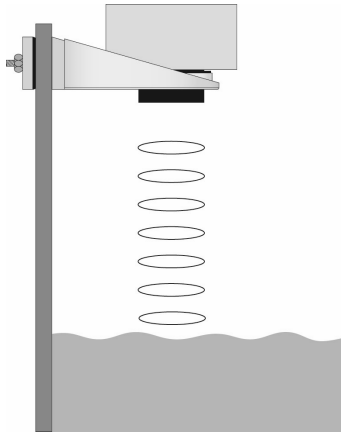

5. **Stand Pipe:** A standpipe maybe used to dampen turbulence or when foam is present in the application.
  - a. Pipe can be made of any material.
  - b. Select a minimum 3" ID pipe for the stand pipe.
    - i. A 2" pipe is usable with the Series ULSS & ULSM, but is the minimum.
    - ii. Pipes larger than 3" can also be used.
  - c. Use a coupling and reducer bushing to attach the Series ULS to the pipe.
    - i. Be sure to use a plastic reducing bushing such as ULS-ACC-121 (2" T x 1" T) fitting or the ULS-ACC-221 (2" S x 1" T) fitting.
    - ii. For the Series ULSL, use a reducer bushing such as ULS-ACC-131 (3" T x 2" T) fitting or the ULS-ACC-231 (3" S x 2" T) fitting.
  - d. The pipe length should run the measurement span and the bottom of the pipe should remain submerged at all times to prevent foam from entering the pipe.
  - e. Cut a 45° notch at the bottom of the pipe and drill a 1/4" pressure equalization hole in the dead band.
  - f. The pumps should not drive liquid past the open end of the stand pipe which causes the liquid in the pipe to oscillate.

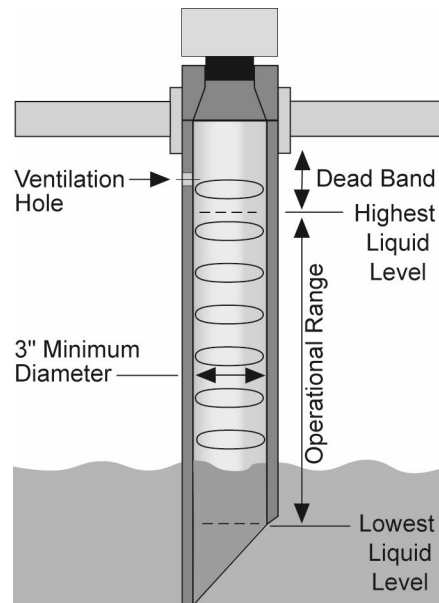

This tool is designed to help solve operational issues. Changing these setting will alter the performance of your unit. Please read through this HELP file to assist you in making adjustments or if you are still unclear about a specific issue, please contact Dwyer Instruments, Inc. Applications Engineering.

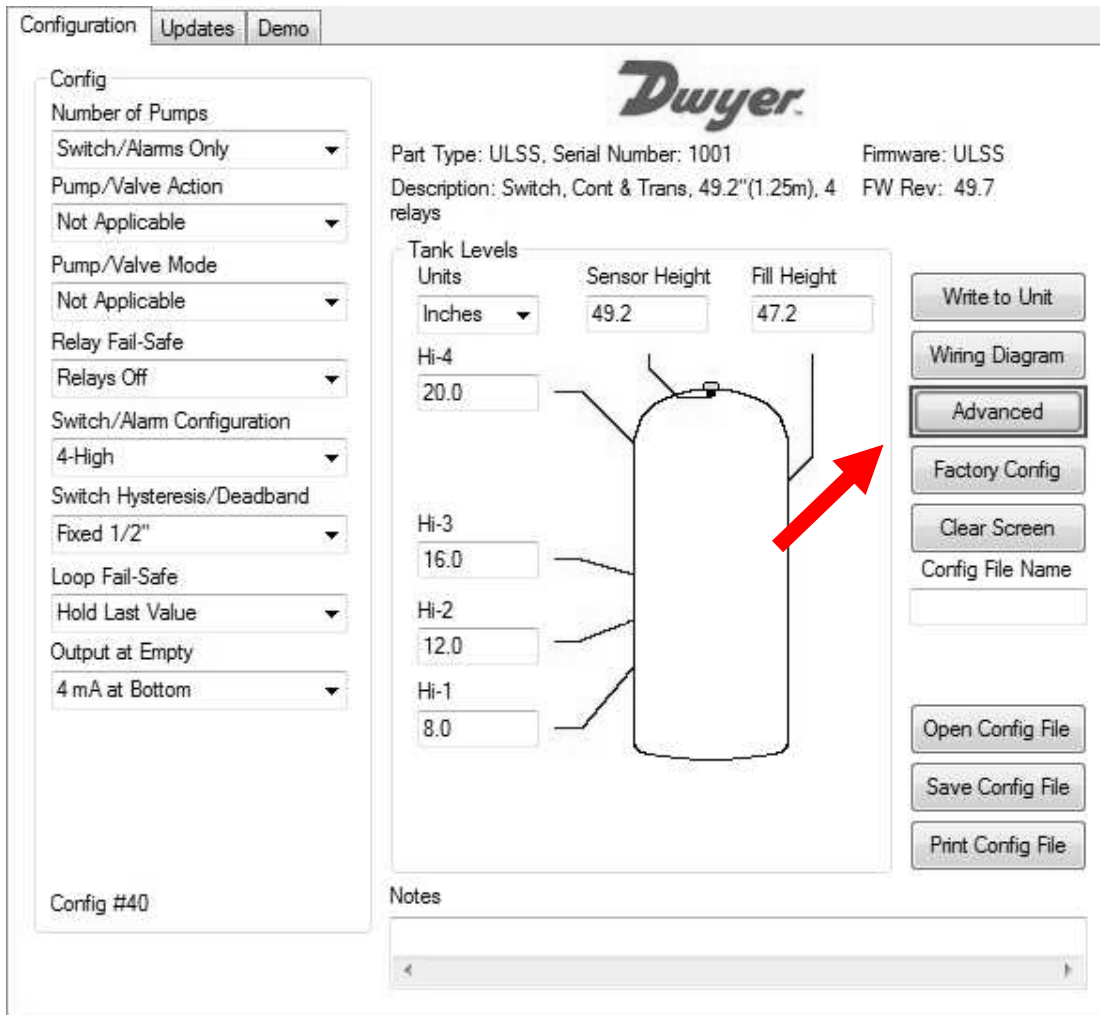

**Note:** When the Advanced Button is highlighted with a RED border, this indicates you have selected an advanced feature.



The screenshot shows a dialog box titled "Advanced" with the following content:

Advanced

ADDITIONAL FEATURES.

- Increase Output Filtering
- Decrease Output Filtering
- Stabilize Output in Deadband
- Turn OFF Fast Level Changes
- Turn On Noisy Mount Start Filter

INVERT RELAY STATES.

- Invert Relay 1 (blue)
- Invert Relay 2 (orange)
- Invert Relay 3 (yellow)
- Invert Relay 4 (purple)

Failsafe will also invert unless you click below:

- Do not Invert Failsafe

Update      Cancel

- **Increase Output Filtering:** Placing a check mark in the box will increase the filtering (averaging) of the analog output. Use this filter if the 4 to 20 mA output requires a smooth output for the application such as open channel flow measurement.
- **Decrease Output Filtering:** Placing a check mark in the box will eliminate all filtering (averaging) of the analog output. Enables a pulse by pulse level reading. Use this filter to see changes in level after every sound pulse.

**Note:** Never check increase output filtering and decrease output filtering at the same time.

- **Stabilize Output in Dead band:** Placing a check mark in the box will activate a filter to hold the output at Full Level if the level enters the dead band of the Series ULS. This filter requires the level to leave the dead band at a smooth and steady rate.
- **Turn OFF Fast Level Changes:** Placing a check mark in the box will turn off the filter enabling fast level changes. Use this filter if your application has very smooth, slow and steady level changes. The filter instructs Series ULS to look only for small incremental changes in level.
- **Turn ON Noisy Mount Start Filter:** Placing a check mark in the box will activate a filter that reduces sound interference from the installation mount. Use this filter if the Series ULS will not go to full range in the installation.
- **Invert Relay States:** Placing a check mark in any of the four boxes will reverse the state of that relay. For example, if relay 4 is a high alarm that energizes above 50" of liquid, checking the invert box will reverse so the relay will energize when it is below 50" of liquid. Inverting the relay will also invert the fail-safe of the relay. If the relay is fail-safe On, inverting the relay will make it fail-safe Off.
- **Fail-Safe will also invert unless you check below:** This button will not invert the fail-safe when a relay is inverted.

**Updating ULSX-CAL Software:** ULSX-CAL software can be updated directly from the software. Simply click on the **Updates** Tab at the top of the window and press the “**Download**” button. Make sure that your computer has access to the Internet. If not, an error window will appear.

When the **Download** button is pressed, the software will check the version of software you are using with the most recent version at Dwyer Instruments, Inc. If the versions are similar, a window indicating that the most recent version is installed. If not, then a window will appear asking to download the latest version. Follow the instructions for installing the latest version.

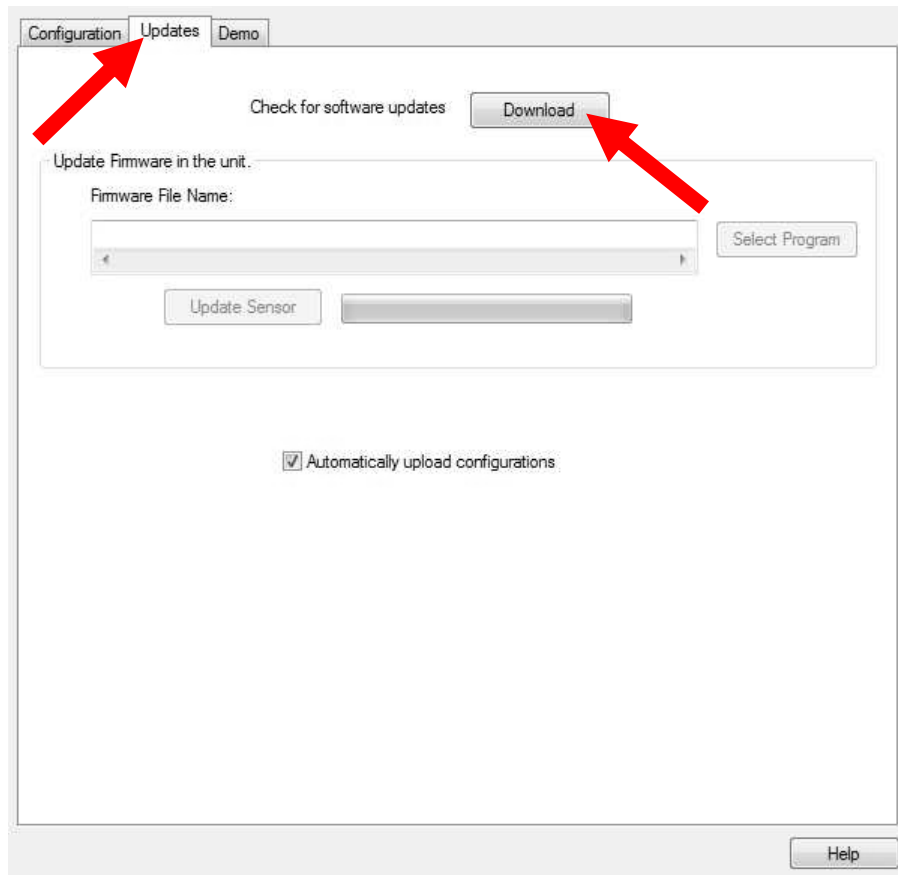

**Updating Transmitter Firmware:** ULSX-CAL software can also be used to update firmware inside the Series ULS transmitter. This feature allows the transmitter to be updated when new features are added. First open ULSX-CAL with an Series ULS transmitter connected and the latest version of ULSX-CAL installed to your PC.

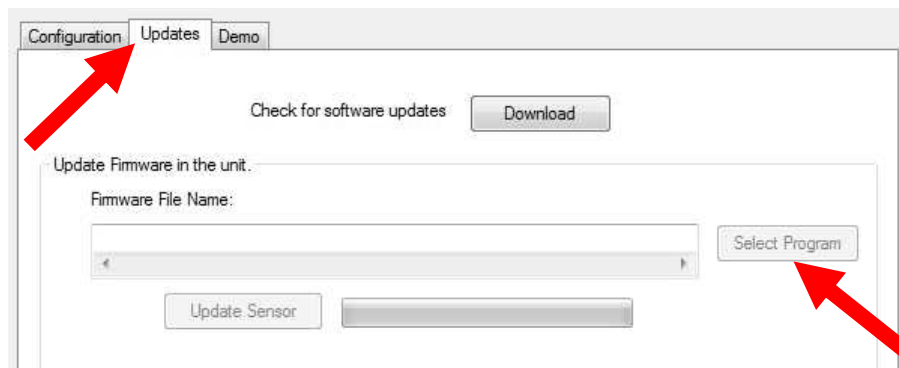

Click on the **“Updates”** Tab and then click on **“Select Program”** to select the firmware update.

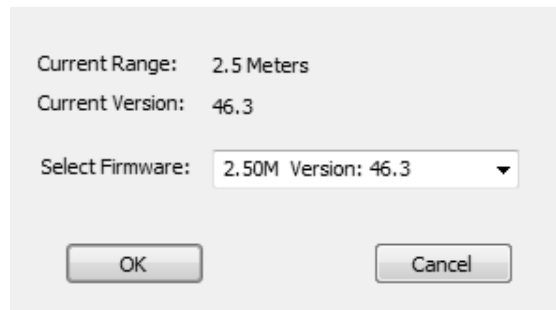

Select the latest version of the firmware file and click on OK.

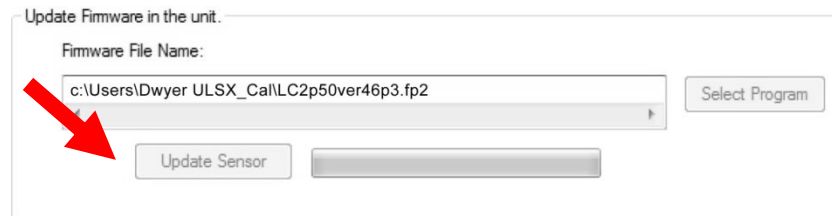

Confirm that the address is correct and then click on **“Update Sensor”** to begin the firmware update. This step should take less than 1 minute. You can follow the progress with the status bar to the right of the Update Sensor button. When completed, click on the Configuration tab to configure the transmitter. *Remember, when the firmware has been updated, the unit will return to its original factory settings.*

- If there is a communication interruption during the update, the process will stop. It is OK to click on Update Sensor again to start the process over again.

**Factory Default:** Pressing the “**Factory Config**” button in the Configuration menu will return the screen to the following settings. Out of the box, the Series ULS will output a 4-20 mA output that is maximized for its operational range.

- **Series ULSS** – 4 mA @ 4.1’ (1.25 m) away and 20 mA @ 2” (5 cm) away from sensor.
- **Series ULSM** – 4 mA @ 9.8’ (3.0 m) away and 20 mA @ 4” (10 cm) away from sensor.
- **Series ULSL** – 4 mA @ 18.0’ (5.5 m) away and 20 mA @ 8” (20 cm) away from sensor.

**Factory Defaults Table**

The screenshot shows the Dwyer configuration interface with the following settings:

- Configuration:** Updates, Demo
- Config:**
  - Number of Pumps: Switch/Alarms Only
  - Pump/Valve Action: Not Applicable
  - Pump/Valve Mode: Not Applicable
  - Relay Fail-Safe: Relays Off
  - Switch/Alarm Configuration: 4-High
  - Switch Hysteresis/Deadband: Fixed 1/2"
  - Loop Fail-Safe: Hold Last Value
  - Output at Empty: 4 mA at Bottom
- Part Type:** ULSS, Serial Number: 1001, Firmware: ULSS
- Description:** Switch, Cont & Trans, 49.2"(1.25m), 4 relays, FW Rev: 49.7
- Tank Levels:**
  - Units: Inches
  - Sensor Height: 49.2
  - Fill Height: 47.2
  - Hi-4: 20.0
  - Hi-3: 16.0
  - Hi-2: 12.0
  - Hi-1: 8.0
- Buttons:** Write to Unit, Wiring Diagram, Advanced, **Factory Config** (highlighted with a red arrow), Clear Screen, Config File Name, Open Config File, Save Config File, Print Config File.
- Notes:** Config #40

### Testing the Transmitter

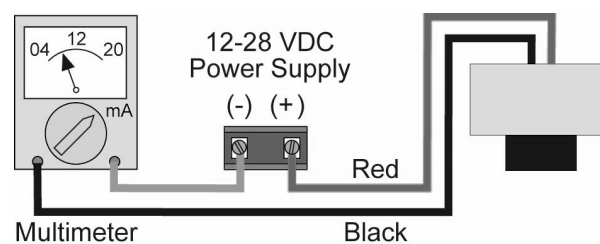

1. Connect a multimeter in series with the black wire to read the current output.
2. Verify that the current increases (tank filling) and decreases (tank emptying) appropriately in the calibrated span.
3. If not, carefully observe and attempt to correlate any installation, level or application event for more specific troubleshooting direction.

PROBLEM	SOLUTION
Transmitter indicates a current of 0 mA	Check the wiring for an open circuit. An open circuit is the most common issue with a 0 mA signal.
Transmitter jumps to a current reading between 19 and 20 mA	Check the installation of the transmitter. Bad installation fittings will cause false signals near the top of the tank, which typically translates to a signal between 19 and 20 mA. Also look for interference just below the transmitter. If the transmitter is installed in a metal fitting, switch to a plastic fitting.
Transmitter indicates a current over 23 mA	Immediately check the wiring for a short circuit. The Series ULS is current limited to 22 mA. Anything above 23 mA indicates a short circuit.
Transmitter always jumps to the LOST condition	Check the dimensional configuration ( <b>Height</b> and <b>Fill-H</b> ) of the Series ULS. Make sure that the <b>Fill-H</b> setting corresponds to the full level of liquid (from the bottom up) and not the distance from the transmitter to the liquid (top down).
Output of transmitter is opposite of the level of liquid	Check the <b>Output at Empty</b> Setting.
No Unit Detected in ULSX-CAL	<p>ULSX-CAL cannot detect a Series ULS connected to the computer.</p> <ul style="list-style-type: none"> <li>• Check that the Fob is connected to the USB port.</li> <li>• Check that all four wires (Red, Black, White and Green) are securely attached to the Fob.</li> <li>• Check in Device Manager that drivers are present under Universal Serial Bus controllers.</li> </ul>
Internet error. The server name or address could not be resolved.	This is a warning indicating the computer configuring Series ULS is not connected to the internet. Click <b>OK</b> to continue. Dwyer Instruments, Inc. recommends being connecting to the internet for all configurations. Not being connected to the internet will not prevent the Series ULS from being configured.
Cannot access some of the features in Configuration	As choices are made in Configuration, ULSX-CAL will begin to eliminate functions that are no longer active. To reset Configuration or get access to all the features, click on the <b>Clear Screen</b> button.
Relay closes, but does not open again	An inductive kick may be holding the relay closed. If switching 24 VDC, make sure a diode has been installed to act as a snubber (see Step Eight). <b>Note:</b> <i>Series ULS uses latching relays. When power is removed to the sensor, the relays will remain in their last state. Ex: If the relay is energized, when power is removed, the relay will remain in an energized state.</i>
Relay chatters on and off repeatedly	Most likely the turbulence in the tank is causing the chatter. Increase the Hysteresis setting to correct.

**MAINTENANCE/REPAIR**

Upon final installation of the Series ULSS, ULSM or ULSL, no routine maintenance is required. The Series ULSS, ULSM or ULSL is not field serviceable and should be returned if repair is needed (field repair should not be attempted and may void warranty).

**WARRANTY/RETURN**

Refer to “Terms and Conditions of Sale” in our catalog or on our website. Contact customer service to receive a Return Goods Authorization number before shipping your product back for repair. Be sure to include a brief description of the problem plus any relevant application notes.

Dwyer Instruments, Inc.  
Attn: Repair Department  
102 Highway 212  
Michigan City, IN 46360