

AUTORANGE MULTIMETER

Operation manual



CONTENTS:

1. SAFETY PRECAUTIONS AND PROCEDURES	2
1.1. Preliminary	2
1.2. During use	3
1.3. After use	3
1.4. Measuring (overvoltage) categories definitions	3
2. GENERAL DESCRIPTION	4
3. PREPARATION FOR USE	4
3.1. Initial	4
3.2. Supply voltage	4
3.3. Calibration	4
3.4. Storage	4
4. OPERATING INSTRUCTIONS	5
4.1. Instrument - description	5
4.1.1. Front panel	5
4.2. Description of function keys	5
4.2.1. HOLD key	5
4.2.2. R (RANGE) key	5
4.2.3. REL key	5
4.2.4. SEL key	6
4.2.5. Backlight key (∇)	6
4.2.6. Auto power off	6
4.3. Measurements	6
4.3.1. DC Voltage measurement	6
4.3.2. DC Current measurement	8
4.3.3. AC Current measurement	9
4.3.4. Resistance measurement	10
4.3.5. Continuity test	11
4.3.6. Diode test	12
4.3.7. Frequency measurement	13
4.3.8. Duty Cycle measurement	14
4.3.9. Capacitance measurement	15
5. MAINTENANCE	16
5.1. General Information	16
5.2. Batteries replacement	16
5.3. Fuse replacement	16
5.4. Cleaning	17
6. TECHNICAL SPECIFICATIONS	17
6.1. Technical features	17
6.1.1. Safety	19
6.1.2. General data	19
6.2. Environment	19
6.2.1. Environmental conditions	19
6.2.2. EMC	19
6.3. Accessories	19
7. SERVICE	19

1. SAFETY PRECAUTIONS AND PROCEDURES

This meter is in compliance with safety Standards EN 61010-1 related to electronic measuring instruments. For your own safety and to avoid damaging the instrument follow the procedures described in this instruction manual and read carefully all notes preceded by this symbol . When taking measurements:

- Avoid measuring in humid or wet places - Make sure that humidity is within the limits indicated in paragraph 6.2.1.
- Avoid measuring in rooms where explosive gas, combustible gas, steam or excessive dust is present.
- Keep you insulated from the object under test.
- Do not touch exposed metal parts such as test lead ends, sockets, fixing objects, circuits etc.
- Stop operating if you notice anomalous conditions such as breakages, deformations, fractures, leakages of battery liquid, blind display etc.
- Be particularly careful when measuring voltages exceed 20V ,so that may avoid risk of electrical shocks.

The following symbols are used:



CAUTION - Refer to the instruction manual - Improper use may damage the instrument or components



Danger high voltage: Risk of electric shocks



Double insulated meter



AC voltage or current



DC voltage or current

1.1. PRELIMINARY

- This instrument has been designed for use in environments of pollution degree 2.
- It can be used for **VOLTAGE** and **CURRENT** measurements on installations of over voltage CAT III 1000V and CAT IV 600V.
- This instrument is not suitable for measurements of non sine wave voltage and current.
- When using the instrument always follow the safety regulations which aimed at protecting you against the dangerous electric currents and protecting the instrument against incorrect operations.
- Only the leads supplied with the instrument guarantee compliance with the safety standards in force. They must be in good conditions and, recommend to replace with identical ones.
- Do not test or connect to any circuit which exceeds the specified overload protection.
- Do not effect measurements under environmental conditions which exceed the limits that indicated in paragraphs 6.1.1 and 6.2.1.
- Make sure that batteries are properly installed.
- Before connecting the test probes to the installation, make sure that the rotary selector is positioned on the right function.
- Make sure that LCD and rotary selector indicate the same function.

1.2. DURING USE



CAUTION

An improper use may damage the instrument and/or its components or injure the operator.

- When changing the range, first disconnect the test leads from the circuit under test in order to avoid any accident.
- When the instrument is connected to measure circuits, never touch any unused terminal.
- When measuring resistors, do not add any voltage though there is a protection circuit, excessive voltage could cause malfunctioning.
- If the displayed values remain unchanged during measurement, check whether the HOLD function is activated or not.

1.3. AFTER USE

- Turn the meter off after ends of the measurement.
- If you expect not to use the instrument for a long period, please remove the battery to avoid leakages of battery which may damage its inner components.

1.4. MEASURING (OVERVOLTAGE) CATEGORIES DEFINITIONS

EN 61010-1: Safety requirements for electrical equipment for measurement, control and laboratory use, Part 1: General requirement gives a definition of measuring category, usually called overvoltage categories:

- **Measurement category IV** is for measurements performed at the source of the low-voltage installation.
Examples: Electricity meters and measurements on primary over-current protection devices and ripple control units.
- **Measurement category III** is for measurements performed in the building installation.
Examples: Measurements on distribution boards, circuit breakers, wiring, including cables, bus-bars, junction boxes, switches, socket-outlets in the fixed installation, and equipment for industrial used as well as some other equipments for stationary motors with permanent connection to the fixed installation.
- **Measurement category II** is for measurements performed on circuits directly connected to the low voltage installation.
Examples: Measurements on household appliances, portable tools and similar equipments.
- **Measurement category I** is for measurements performed on circuits not directly connected to MAINS.
Examples: Measurements on circuits not derived from MAINS, and specially protected (internal) MAINS-derived circuits. In the latter case, transient stresses are variable; for that reason, the norm requires that the transient withstand capability of the equipment is known to the user.

2. GENERAL DESCRIPTION

This meter performs the following measurements:

- DC and AC TRMS Voltage
- DC and AC TRMS Current
- Resistance and Continuity test
- Frequency
- Capacitance
- Diode test

All selectable by using 10-position rotary selector (including OFF position), functions keys (see chapter 4.2) and analogical bar-graph are featured. The selected quantity is displayed with indication of measuring unit and activating functions.

The instrument also features Auto Power Off function which performs automatic switching off in 30 minutes after last selector rotation or function selection is done.

2.1. MEAN VALUE AND TRMS: DEFINITION

Safety testers for AC quantities are divided into two big families:

- MEAN VALUE instruments, measuring only the value of the wave at the fundamental frequency (50 or 60 Hz)
- TRUE ROOT MEAN SQUARE (or "TRMS") instruments, measuring the true root mean square value of the quantity under test.

In presence of a perfectly sinusoidal wave, both families provide identical results. While in presence of distorted waves, readings are different. Mean value instruments provide only the value of the fundamental wave while TRMS instruments provide the value of the entire wave, including harmonics (within the pass band of the instrument). Accordingly, if the same quantity is measured with both kinds of instruments, the measured values are identical only if the wave is purely sinusoidal. Should it be distorted, TRMS instruments provide higher values than MEAN VALUE instruments.

2.2. TRUE ROOT MEAN SQUARE VALUE AND CREST FACTOR: DEFINITION

The effective current value is defined as follows: "In an interval of time equivalent to a period, an alternate current with effective value having an intensity of 1A, by passing on a resistor, disperses the same energy which would be dispersed in the same period of time by a direct current having an intensity of 1A". From this definition comes the numerical

expression: $G = \sqrt{\frac{1}{T} \int_{t_0}^{t_0+T} g^2(t) dt}$ The effective value is indicated as RMS (*root mean square*).

The Crest Factor is defined as the ratio between the Peak Value of a signal and its effective value: $CF (G) = \frac{G_p}{G_{RMS}}$. This value varies according to the waveform of the signal,

for a purely sinusoidal wave it's worth $\sqrt{2} = 1.41$. In presence of distortions the Crest Factor assumes higher values as long as the wave distortion is higher.

3. PREPARATION FOR USE

3.1. INITIAL

The instrument was checked for both mechanically and electrically prior to shipment. All possible cares and precautions were taken to let you receive the instrument in perfect conditions.

Make sure that all standard accessories mentioned in paragraph are included. Should you have to return back the instrument for any reason please follow the instructions mentioned in paragraph

3.2. SUPPLY VOLTAGE

The instrument is supplied by 1x9V battery type NEDA1604 JIS006P IEC6F22. When battery is low, a low battery indication "F" is displayed. To replace/insert battery, please refer to paragraph 5.2.

3.3. CALIBRATION

The instrument complies with the technical specifications which contained in this manual and such compliance is guaranteed for 1 year. Annual recalibration is recommended.

3.4. STORAGE

After a period of storage under extreme environmental conditions exceeding the limits mentioned in paragraph 6.2.1, please have the instrument resume to normal measuring conditions before using it.

4. OPERATING INSTRUCTIONS

4.1. INSTRUMENT - DESCRIPTION

4.1.1. Front panel

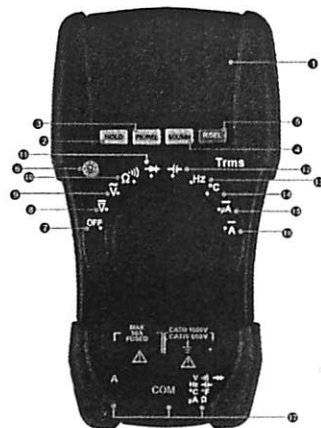

LEGEND:



1. LCD
2. HOLD Key
3. PK/ REL Key
4. MX/ MN Key
5. R/SEL Key
6. Backlight  Key
7. OFF position
8. DCV position
9. ACV position
10. Posizione Ω/·))
11.  position
12.  position
13. Hz position
14. μADC position
°C and °F position
15. μAAC position
DCμA and ACμA position)
16. DCA and ACA position
17. COM, A, and Ω/Hz/μA
°C °F

Fig. 1: Instrument description

4.2. FUNCTION KEYS

When pressing a key, the corresponding symbol is displayed with a beep. To resume default state, turn the selector to other function.

4.2.1. HOLD key

Press **HOLD** key, the measured value is frozen on the display and symbol "HOLD" appears. Press again **HOLD** to disable this function and resume normal operation.

4.2.2. PK/REL key

This key performs double function of measuring max/min peak values (active for $\sim V$ and $\sim \mu A$ positions of rotary selector) and features relative measurements (REL) for $\sim V$, $\approx A$, Hz, Ω \rightarrow), \rightarrow , \rightarrow and $\sim \mu A$ positions of rotary selector.

This key features double function of measuring max/min peak values (active for $\sim V$ and $\sim \mu A$ positions of rotary selector) and performs relative measurements (REL) for $\sim V$, Hz, Ω \rightarrow), \rightarrow , \rightarrow and $^{\circ}C/^{\circ}F$ positions of rotary selector.

Press cyclically **PK/REL** to measure and save peak values. "P_{MAX}" and "P_{MIN}" symbols on the display correspond to Maximum Peak and Minimum Peak values respectively which are continuously updated. Press and hold **PK/REL** key for at least 3 seconds, "CAL" symbol appears on the display and the meter performs auto calibration which permits a higher accuracy on peak measurements.

To exit this function, press and hold **PK/REL** for at least one second or rotate the selector on another position.

Press **PK/REL** key, the relative measurement is activated: the meter saves the (offset) value on the display and "REL" symbol is shown. The following measurement will be referred to this offset value. Press **PK/REL** key again, the offset value is shown and "REL" symbol is blinking.

To exit this function, press and hold **PK/REL** for at least one second or rotate the selector on another position.

4.2.3. MX/MN key

Press **MX/MN** key, maximum or minimum value is measured. Both values will be stored and automatically updated once a higher value (MAX) or lower value (MIN) is measured. The symbol corresponds to the desired function is displayed: "MAX" for maximum value, "MIN" for minimum value. **MX/MN** key is disabled when **HOLD** function is activated.

To exit this function, press and hold **MX/MN** key for 1 second or rotate the selector to other positions.

4.2.4. R/SEL key

Press **R/SEL** key, the manual selection of measured range (Exception: \rightarrow , $\sim A$ and $\sim A$ positions) and the selection of a double function which are included on selector (by choosing between Ω \rightarrow) measure and AC or DC Current) are applicable. "MANU" symbol is shown by pressing **R/SEL** key and the cyclically pressure of the key changes the measuring range and fixes the decimal point on the display. Press **R/SEL** key at least 1 second or rotate the selector to exit this function and restore, now "AUTO" symbol is displayed.

4.2.5. Backlight key (\rightarrow)

Press \rightarrow key to activate backlight function on the display. The function automatically disabled itself after few seconds and is available for each position of the rotary selector.

4.2.6. Disable Auto Power OFF

In case the meter is supposed to be used for long time, you may disable Auto Power OFF function. Once Auto Power OFF function is disabled, meter stays continuously. To disable Auto Power OFF function

- Switch OFF the meter.
- Press and hold **PK/REL** key until  icon is disappeared. Now it is under non-Auto Power Off condition.

The Auto Power OFF function is automatically activated when turning ON the meter again.

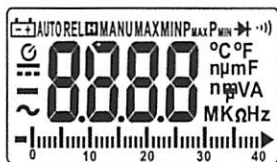

4.3. MEASUREMENTS

4.3.1. DC Voltage measurement

CAUTION



The maximum input for DC voltage is 1000V. Do not attempt to measure higher voltages, it may cause electrical shocks or damages to the instrument.

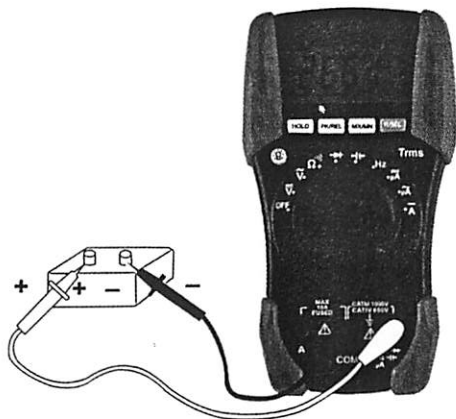
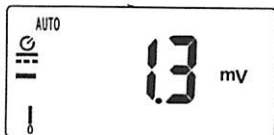

Fig. 2: Operation for DC Voltage measurement

1. Select $V_{\text{---}}$ position.
2. Press **R/SEL** key to select the correct range or use Auto range feature (See paragraph 4.2.4). If the voltage value under test is unknown, select the highest range.
3. Insert the test leads into the jacks, plug the red one into \rightarrow HzV Ω μ A jack and black plug into **COM** jack (see Fig. 2).
4. Connect both red and black test leads to the positive and negative poles of the circuit under test respectively. Now voltage value is displayed.
5. If "O.L." is displayed, select a higher range.
6. The symbol "-" displayed indicates that voltage has opposite direction with regard to the connection.
7. For HOLD function, Minimum and Maximum value measurement and Relative measurement operation. Please refer to paragraph 4.2.



4.3.2. AC Voltage measurement

CAUTION



The maximum input for AC voltage is 750Vrms. Do not attempt to measure higher voltages, so to avoid electrical shocks or damages to the instrument.

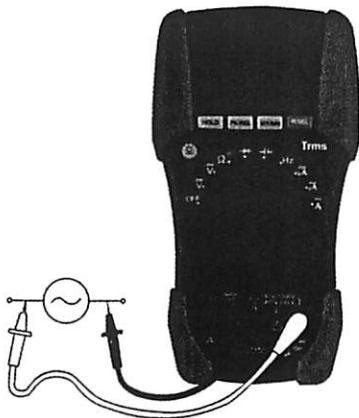
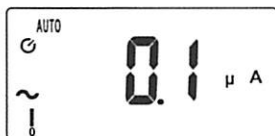

Fig. 3: Operation for AC Voltage measurement

1. Select $V\sim$ position.
2. Press **R/SEL** key to select the correct range or use auto-range feature (see paragraph 4.2.4). If voltage value under test is unknown, select the highest range.
3. Insert red leads into $\sim HzV\Omega\mu A$ jack and black plug into **COM** jack (see Fig. 3).
4. Connect both test leads to the circuit under test. The voltage value is displayed.
5. If "O.L" is displayed, select a higher range.
6. For **HOLD** function, Minimum and Maximum value measurement and Peak measurement. Please refer to paragraph 4.2.



4.3.3. DC Current measurement

CAUTION



The maximum input for DC current is 10A. Do not attempt to measure higher current, so to avoid electrical shocks or damages to the instrument.

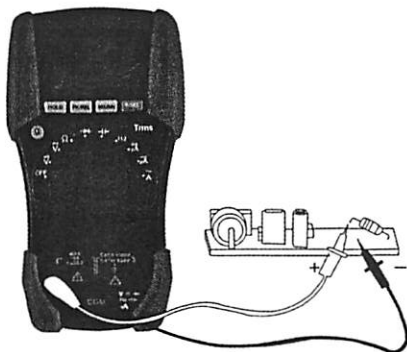
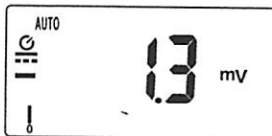

Fig. 4: Operation for DC Current measurement

1. Power off the circuit under test.
2. Select $A\sim$ position. Icon " \sim " is displayed.
3. Insert red plug into **A** jack and black plug into **COM** jack (see Fig. 4).
4. Connect both test leads in series with the circuit whose current is to be measured respecting the polarities.
5. Energize the circuit under test. The current value will be displayed.
6. If the measured value is lower than **4mA**, to get a better resolution:

- Switch off the circuit under test.
 - Select $\sim\mu\text{A}$ position.
 - Remove the red test lead from **A** jack, and insert it into $\rightarrow\text{HzV}\Omega\mu\text{A}$ jack and power the circuit under test. Press **R/SEL** key if necessary to select higher range.
7. The symbol "-" on the instrument indicates that current is at opposite direction with regard to the connection.
 8. For **HOLD** function, Minimum and Maximum value measurement and Relative measurement operation. Please refer to paragraph 4.2.



4.3.4. AC Current measurement

CAUTION



The maximum input for DC current is 10A. Do not attempt to measure higher currents, so to avoid electrical shocks or damages to the instrument.

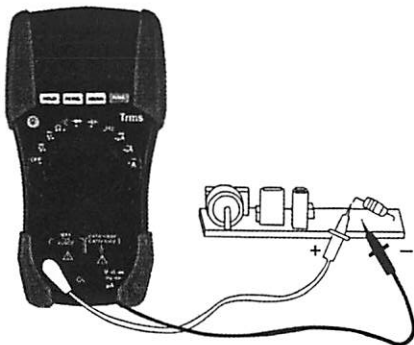

Fig. 5: Operation for AC Current measurement

1. Power off the circuit under test.
2. Select $\sim\text{A}$ position. Press **R/SEL** key to select AC measurement. The " \sim " symbol is shown at display.
3. Insert the test leads into the jacks, the red plug into **A** jack and black plug into **COM** jack (see Fig. 5).
4. Connect both red and black plugs in series with the circuit whose current is to be measured.
5. Energize the circuit under test. The current value will be displayed.

6. If the measured value is lower than 4mA, to get a better resolution:
 - Switch off the circuit under test.
 - Turn the selector on $\sim\mu\text{A}$.
 - Remove the red test lead from A jack, and insert it into $\rightarrow\text{HzV}\Omega\mu\text{A}$ jack and power the circuit under test. Press R/SEL key if necessary to select a higher range.
7. For HOLD function, Minimum and Maximum value measurement, Peak measurement (for $\sim\mu\text{A}$ position) and for Relative measurement (for $\approx\text{A}$ position) operation, please refer to paragraph 4.2.



4.3.5. Resistance measurement and Continuity Test



CAUTION

Remove power from the circuit being tested and discharge all capacitors before taking resistance measurements on the circuit.

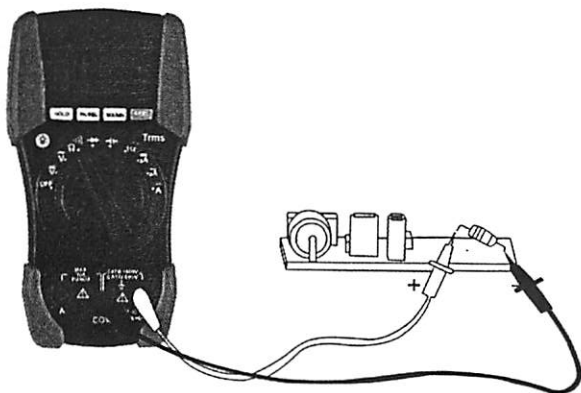

Fig. 6: Operation for Resistance measurement and Continuity test

1. Select Ω position.
2. Insert the test leads into the jack, the red plug into $\rightarrow\text{HzV}\Omega\mu\text{A}$ jack and black plug into COM jack (see Fig. 6).
3. Connect the test leads to the circuit under test. The resistance value is displayed.

4. Press **R/SEL** key to select a correct range or use auto-range feature (see paragraph 4.2.4). If the resistance value under test is unknown, select the highest range.
5. If "**O.L.**" is displayed, a higher range must be selected.
6. The continuity test is always active and the test is performed, using the test leads in the same way of resistance measurement. The buzzer is on for resistance values $< 35\Omega$.
7. For **HOLD** function, Minimum and Maximum value measurement and Relative measurement operation, please refer to paragraph 4.2.



4.3.6. Diode test



CAUTION

Remove power from the circuit being tested and discharge all capacitors before taking diode test.

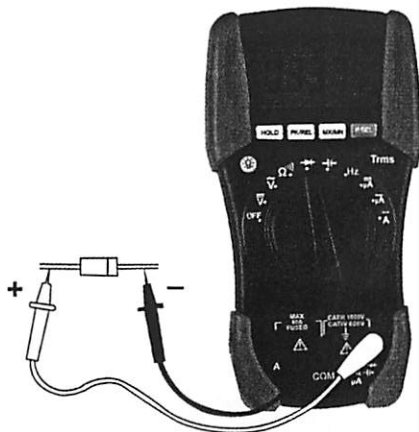
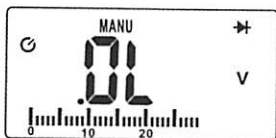

Fig. 7: Operation for Diode test

1. Select \rightarrow position.
2. Insert test leads into the jacks, the red plug into \rightarrow HzVΩμA jack, and black plug into COM jack.

3. Connect test leads to the diode under test, observing proper polarities (see Fig. 7). The threshold voltage value of direct polarization is shown at display. The meter displays the diode voltage to approximately 0.4 ~ 0.9V for good junction.
4. If threshold voltage value is 0V, the diode P-N junction is shorted circuit.
5. If "O.L." is displayed the diode terminals are reversed or the diode P-N junction is damaged.
6. For HOLD function, Minimum and Maximum value measurement and Relative measurement, please refer to paragraph 4.2.



4.3.7. Capacitance measurement



CAUTION

Remove power from the circuit being tested and discharge all capacitors before taking capacitance measurements in circuit. Use the short test lead pair for measurement to reduce the stray capacitance. Observe the display before connecting the test capacitor, which may have a reading other than zero every time the range is changed. Subtract this offset reading from the displayed reading of the test result of a capacitor to obtain the true value. Connect the test capacitor to the inputs respecting the polarity connections when required. Due to internal delay time, bar graph is not available in capacitance measurement mode.

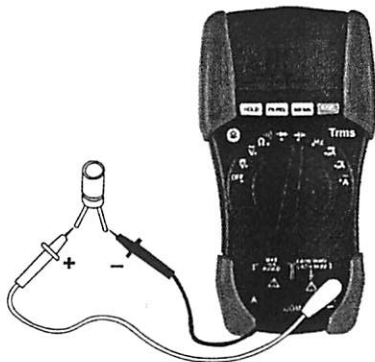

Fig. 8: Operation for Capacitance measurement

1. Select \rightarrow position.
2. Insert test leads into the jacks, plug red into \rightarrow HzV Ω μ A jack and plug black into COM jack (see Fig. 8).
3. Connect red and black test clamps to the capacitor terminals respecting if necessary the proper polarities. The capacitance value is shown on display.
4. Press R/SEL key to select the correct range or use auto-range feature (see paragraph 4.2.4). If the capacitance value under test is unknown, select the highest range.
5. If "O.L" is displayed the maximum readable value is reached.
6. For HOLD function, Minimum and Maximum value measurement and Relative measurement, please refer to paragraph 4.2.



4.3.8. Frequency measurement



CAUTION

The maximum input for AC voltage is 750Vrms. Do not attempt to measure higher voltage, so to avoid electrical shocks or damages to the instrument.

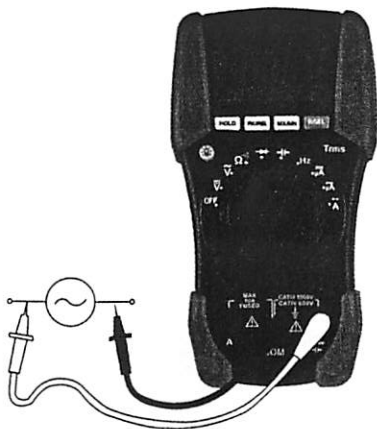

Fig. 9: Operation for Frequency measurement

1. Select **Hz** position.
2. Insert test leads into the jacks, red for $\text{HzV}\Omega\mu\text{A}$ jack and black for **COM** jack (see Fig. 9).
3. Connect test leads to the circuit under test. The frequency value will be displayed.
4. Press **R/SEL** key to select the correct range or use the auto-range feature (see paragraph 4.2.4). If frequency value under test is unknown, select the highest range
5. If "**O.L**" is displayed, it stands the maximum readable value is reached.
6. For **HOLD** function, Minimum and Maximum value measurement and Relative measurement, please refer to paragraph 4.2.



4.3.9. Temperature test

CAUTION



The maximum input of AC voltage is 24Vrms DC voltage is 60V. Do not attempt to measure higher voltage to avoid electrical shocks or damages to the instrument.



Fig. 10 : Operation for Temperature measurement

1. Select $^{\circ}\text{C}/^{\circ}\text{F}$ position.
2. Press **R/SEL** key to select the $^{\circ}\text{C}$ and $^{\circ}\text{F}$ readings.

5.3. FUSE REPLACEMENT



CAUTION

Before replacing fuses, disconnect test leads from any energized circuit to avoid electrical shock.

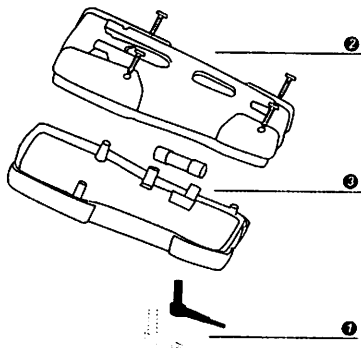

Steps:

1. Turn OFF the meter and disconnect the test leads from the input terminals.
2. Unscrew the four screws of the back holster and remove it.
3. Remove the defective fuse and install with a new fuse of the same size and rating (fast 10A/1000V Bussmann type). Make sure the new fuse is centered in the fuse holder. Re-screw the back holster.

Fig. 11: Fuse replacement

5.4. CLEANING

To clean the instrument, use a soft dry cloth. Never use a wet cloth, solvents or water.

6. TECHNICAL SPECIFICATIONS

6.1. TECHNICAL FEATURES

The accuracy is indicated as [% of reading + number of digits] at 23°C±5°C, < 80%HR

DC Voltage

Range	Resolution	Accuracy	Input impedance	Overload protection
400.0mV	0.1mV	±(0.5%rdg + 3dgt)	10MΩ // <100pF	1000VDC 750VACrms
4.000V	0.001V	±(0.5%rdg + 2dgt)		
40.00V	0.01V			
400.0V	0.1V			
1000V	1V	±(1.0%rdg + 2dgt)		

AC TRMS Voltage

Range	Resolution	Accuracy (50+500Hz)	Input impedance	Overload protection
400.0mV	0.1mV	Not declared	10MΩ // <100pF	1000VDC 750VACrms
4.000V	0.001V	±(1.3%rdg + 5dgt) (50+300Hz)		
40.00V	0.01V	±(1.5%rdg + 3dgt)		
400.0V	0.1V			

750V	1V	(50+500Hz)		
------	----	------------	--	--

DC Current

Range	Resolution	Accuracy (*)	Output voltage	Overload protection
400.0μA	0.1μA	±(1.0%rdg + 2dgt)	<5mV/μA	750Vrms
4000μA	1μA			
10.00A	0.01A		2V max	

AC TRMS Current

Range	Resolution	Accuracy (50+500Hz)	Output voltage	Overload protection
400.0μA	0.1μA	±(1.2%rdg + 5dgt)	<5mV/μA	750Vrms
4000μA	1μA			
10.00A	0.01A	±(1.5%rdg+5dgt) (50 + 399Hz) ±(2.0%rdg+5dgt) (400 + 500Hz)	2Vmax	Fuse 10A/1000V

Resistance

Range	Resolution	Accuracy	Max Open Circuit Voltage	Overload protection
400.0Ω	0.1Ω	±(1.0%rdg + 5dgt)	about 1.3V	600Vrms
4.000kΩ	0.001kΩ	±(0.8%rdg + 2dgt)	about 0.45V	
40.00kΩ	0.01kΩ			
400.0kΩ	0.1kΩ			
4.000MΩ	0.001MΩ	±(1.0%rdg + 2dgt)		
40.00MΩ	0.01MΩ	±(1.5%rdg + 5dgt)		

Diode Test

Feature	Resolution	Accuracy (0.4 + 0.8V)	Test current	Open voltage	Overload protection
	10mV	±(1.5%rdg + 5dgt)	1.5mA	<3V	600Vrms

Continuity Test

Feature	Buzzer	Open voltage	Overload protection
-0)	<35Ω	about 1.3V	600Vrms

Frequency

Range	Resolution	Accuracy	Sensitivity	Overload protection
4.000kHz	0.001kHz	±(0.1%rdg + 2dgt)	>1.5VACrms <5VACrms	600Vrms
40.00kHz	0.01kHz			
400.0kHz	0.1kHz		>2VACrms <5VACrms	
4.000MHz	0.001MHz			
40.00MHz	0.01MHz		Not declared	
400.0MHz	0.1MHz			

Minimum pulse duration: 25ns
30% ≤ Duty Cycle ≤ 70%

6.1.1. Safety

Instrument complies with:	EN 61010-1
Insulation:	Class 2, Double insulation
Pollution degree:	2
Overvoltage category:	CAT III 1000V, CAT IV 600V
Max height:	2000 meters

6.1.2. General data

Mechanical characteristics

Dimensions:	163(L) x 88(W) x 48(H) mm
Weight (including batteries):	Approx. 280g
Power supply	2 batteries 1.5V AAA MN2400 LR03 AM4
Indication of low batteries:	"  " is displayed when batteries are low.
Battery life:	Approx. 170 hours
Display:	3 1/4 LCD with max. reading 3999 counts

6.2. ENVIRONMENT

6.2.1. Environmental conditions

Reference temperature:	23° ± 5°C
Working temperature:	-5 + 40 °C
Relative humidity:	<70%HR
Storage temperature:	-10 + 60 °C
Storage humidity:	<70%HR

6.2.2. EMC

This instrument is designed and tested in compliance with the requirements of the European EMC Directive 89/336/EEC modified with 93/68/CEE and in accordance with Low Voltage Directive 73/23/EEC

6.3. ACCESSORIES

- Test leads, user's manual, batteries, carrying case.

7. SERVICE

This instrument is guaranteed against material or production defects, in accordance with our general sales conditions. During the warranty period the manufacturer reserves the right to decide either to repair or replace the product.

Should you need for any reason to return back the instrument for repair or replacement take prior agreements with the local distributor from whom you bought it. Do not forget to enclose a report describing the reasons for returning (detected fault).



V201011