

INSTRUCTIONS FOR THE 2600 SERIES MICROPROCESSOR BASED TEMPERATURE /PROCESS CONTROL



LOVE CONTROLS

a Division of Dwyer Instruments, Incorporated
PO Box 338 ○ Michigan City, IN 46361-0338
(800) 828-4588 ○ (219) 879-8000 ○ FAX (219) 872-9057
www.love-controls.com

CONTENTS





GETTING STARTED	3
MODEL IDENTIFICATION	4
INSTALLATION	5
WIRING	5
Input Wiring	6
Output Wiring	7
Wiring for 4 to 20mA Transmitter inputs	7
Wiring for Optional Inputs and Outputs	8
Wiring for Option 924 Remote Set Point	8
Wiring for Option 926 Remote Set Point	8
Wiring for Option 928 Remote Set Point	9
Wiring for Option 934 Analog Retransmission	9
Wiring for Option 936 Analog Retransmission	9
Wiring for Option 948 4-Stage Set Point	10
Wiring for Option 992, 993, 995, 996 Serial Communications	11
FRONT PANEL KEY FUNCTIONS	12
PASSWORD TABLE	13
SECURITY LEVEL SELECTION	13
NOTATION CONVENTIONS FOR THE MENUS	14
DISPLAY CONVENTIONS	14
THE HOME DISPLAY	15
Programming and Operation for Ramp / Soak Feature	15
AUTO / MANUAL OPERATION	18
Self Tune Function	18
Operation AND PROGRAMMING OF OPTIONS	19
Options 924, 926, 928, Analog Remote Set Point	19
Option 934, 936, Isolated Analog Retransmission.	20
Option 948, 4-Stage Set Point.	21
Option 992, 993, 995, 996 Serial Communication.	21
Serial Communications Options and Nonvolatile Memory	22
MENU SELECTIONS	23
PRIMARY MENU	23
SECONDARY MENU	24
SECURE MENU	31
ERROR MESSAGES	41-43
CONFIGURATION MENU	44
SPECIFICATIONS	46
INPUT RANGES	49
DIMENSIONS	50

© 2001, Love Controls. All rights reserved. No portion may be copied without the express written consent of Love Controls.



GETTING STARTED

1. Install the control as described on page 5.
2. Wire your control following the instructions on pages 5-11. If you are using a two-wire transmitter as an input, see the drawing and instructions on page 7. Option wiring instructions are on pages 8-11. Option descriptions and specific instructions start on page 19.
3. Most controls do not need many (if any) program changes to work on your process. For best results when changing the programming, make all the necessary changes in the Secure Menu (page 31) before making changes to the Secondary Menu (page 24). If error messages occur, check the Error Messages on page 41-43 for help.





Take the example of a Model 26010 that comes from the factory programmed for type J thermocouples. Suppose for this example you wish to change the input to a 100 ohm Platinum RTD and limit the set point range between 0° and 300°C.

First, enter the Secure menu by pressing and holding the   **UP ARROW & ENTER** keys for 5 Seconds. Press the  **INDEX** key until the display shows `InP` and press the  **DOWN ARROW** until the display shows `P385`. Don't forget to press the  **ENTER** key to retain your setting.

Next, press the  **INDEX** key to display `Unit`. Press the  **DOWN ARROW** until the display shows `C`. Press  **ENTER**.

Next, press the  **INDEX** key until `SPL` is displayed (pass the `dPt`, `InPt`, and `SEnC` selections). Press the  **UP ARROW** until the display shows `0`. Press  **ENTER**.

Finally, press  **INDEX** key to display `SPH`. Press the  **DOWN ARROW** until the display shows `300`. Press  **ENTER**.

The necessary program changes are now complete. After 30 seconds the display will switch back to the temperature reading. If you want to return faster, press the   **UP ARROW & ENTER** keys (at the same time) and then press the   **DOWN ARROW & INDEX** keys (again at the same time). This will 'back out' of the menu and immediately display the temperature reading.

If you want to use Self Tune®, Auto/Manual, or the Ramp/Soak Programmer features, see the special sections on these items. Page numbers for these are in the Contents section on the previous page.

MODEL IDENTIFICATION

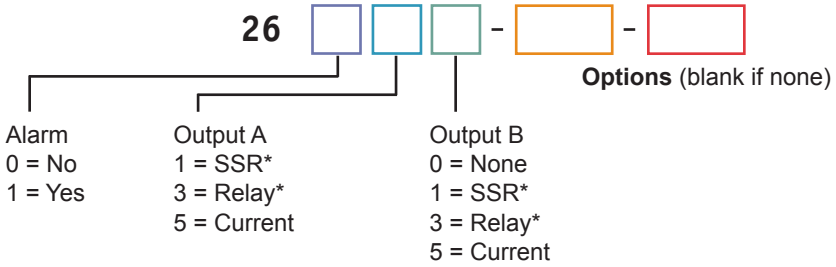

* Note: Switched 15 VDC output standard on Output 1 or Output 3.

Option Description

- 924 Analog Remote Set Point, 0 to 10 VDC, scalable.
- 926 Analog Remote Set Point, 0 to 20 mADC, scalable (may be programmed for 1 to 5mA, 4 to 20 mA, etc.).
- 928 Analog Remote Set Point, 0 to 10,000 ohms, scalable.
- 934 Analog Retransmission of Process Variable or Set Variable, 0 to 20 mA, scalable (may be programmed for 1 to 5mA, 4 to 20 mA, etc.).
- 936 Analog Retransmission of Process Variable or Set Variable, 0 to 10 VDC, scalable.
- 948 4-Stage Set Point. One of four pre-set set point values can be implemented via contact closure.
- 992 RS-485 Serial Communications, Lovelink™ protocol.
- 993 RS-232 Serial Communications, Lovelink™ protocol.
- 995 RS-232 Serial Communications, Modbus® protocol.
- 996 RS-485 Serial Communications, Modbus® protocol.

Lovelink™, Lovelink™II, and Mother Node™ are Trademarks of Love Controls.
MODBUS® is a trademark of Schneider Automation.

INSTALLATION

Mount the instrument in a location that will not be subject to excessive temperature, shock, or vibration. All models are designed for mounting in an enclosed panel.

Select the position desired for the instrument on the panel. If more than one instrument is required, maintain the minimum of spacing requirements as shown on the drawing below. Closer spacing will structurally weaken the panel, and invalidate the IP66, UL type 4X rating of the panel.

Prepare the panel by cutting and deburring the required opening.

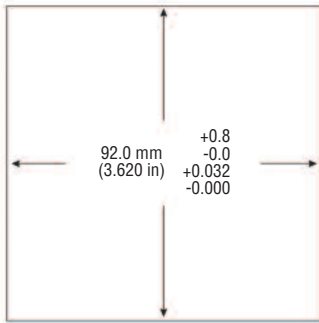

PANEL CUTOUT

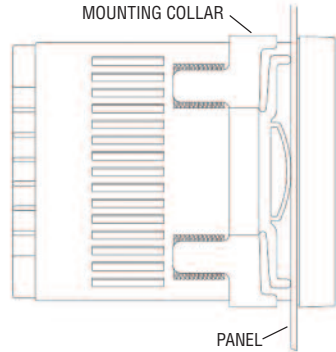

From the front of the panel, slide the housing through the cut out. The housing gasket should be against the housing flange before installing.

From the rear of the panel slide the mounting collar over the housing. Hold the housing with one hand and using the other hand, push the collar evenly against the panel until the spring loops are slightly compressed. The ratchets will hold the mounting collar and housing in place.



CAUTION: It is not necessary to remove the instrument chassis from the housing for installation. If the instrument chassis is removed from the housing, you must follow industry standard practice for control and protection against Electro-Static Discharge (ESD). Failure to exercise good ESD practices may cause damage to the instrument.

WIRING



Do not run RTD, thermocouple, or other class 2 wiring in the same conduit as power leads. Use only the type of thermocouple or RTD probe for which the control has been programmed. Maintain separation between wiring of sensor, optional inputs and outputs and other wiring. See the "Secure Menu" for input selection.

For thermocouple input always use extension leads of the same type designated for your thermocouple.

For supply connections use No. 16 AWG or larger wires rated for at least 75°C. Use copper conductors only. All line voltage output circuits must have a common disconnect and be connected to the same pole of the disconnect.

Input wiring for thermocouple, current, and RTD; and output wiring for current and 15 VDC is rated CLASS 2.

Control wiring is as shown (view is from rear of instrument showing wiring terminals).

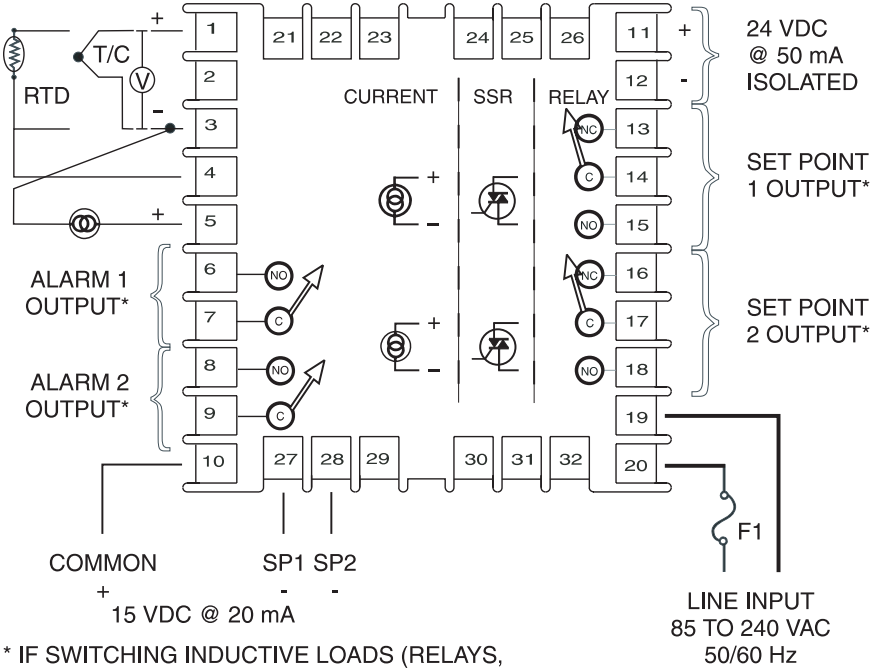

* IF SWITCHING INDUCTIVE LOADS (RELAYS, MOTORS, SOLENOIDS, ECT.) USE AN R/C SNUBBER ACROSS COIL.

F1 = 3/8A 250VAC MEDIUM LAG

Note: Illustrations shown inside the wiring terminals represent internal circuitry. See next page for output wiring chart.

INPUT WIRING

Wire inputs as shown in the chart below.

Terminals	1	3	4	5
Thermocouple	+	-		
RTD - 3 wire	A	B	B	
RTD - 2 wire	A	B & J	J	(Jumper 3 to 4)
Voltage	+	-		
Current		-		+

Key: '+' = positive; '-' = negative; 'A' = 'odd' colored lead; 'B' = 'common' leads; 'J' = Jumper.

OUTPUT WIRING

Wire outputs as shown in the chart below.

Terminals	10	13	14	15	16	17	18	27	28
SP1 SSR			C	NO					
SP1 15 VDC +	+							-	
SP1 Relay		NC	C	NO					
SP1 Current			+	-					
SP2 SSR						C	NO		
SP2 15 VDC +	+								-
SP2 Relay					NC	C	NO		
SP2 Current						+	-		

Key: '+' = positive; '-' = negative; 'NC' = Normally Closed; 'NO' = Normally Open; 'C' = Common.

WIRING FOR 4 TO 20MA TRANSMITTER INPUTS

Wire power and outputs as shown above. Two-wire transmitters wire as shown below. View is of instrument as seen from the rear to show wiring terminals.

For three- or four-wire transmitters follow the wiring instructions provided with your transmitter.



CAUTION: DO NOT WIRE THE 24 VOLT POWER SUPPLY ACROSS THE INPUT OF THE CONTROL. DAMAGE TO THE CONTROL INPUT CIRCUITRY WILL RESULT.

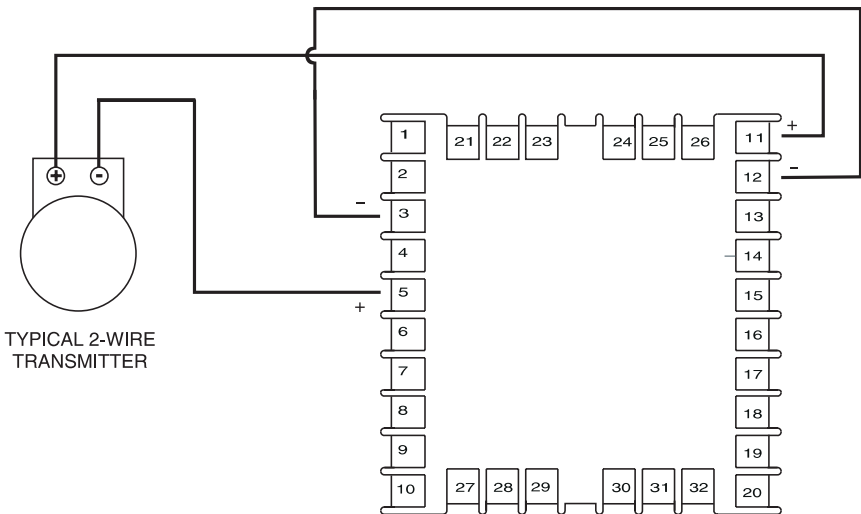

WIRING FOR OPTIONAL INPUTS AND OUTPUTS

All wiring shown below is Class 2. Shielded twisted pair is required for Options 992 and 996. Shielded cable is required for Options 993 and 995. Options 924, 926, and 928 share a common ground with input.



CAUTION: DO NOT RUN SIGNAL WIRING IN THE SAME CONDUIT OR CHASE AS THE POWER WIRING. ERRATIC OPERATION OR DAMAGE TO THE CONTROL CIRCUITRY WILL RESULT.

WIRING FOR OPTION 924 REMOTE SET POINT

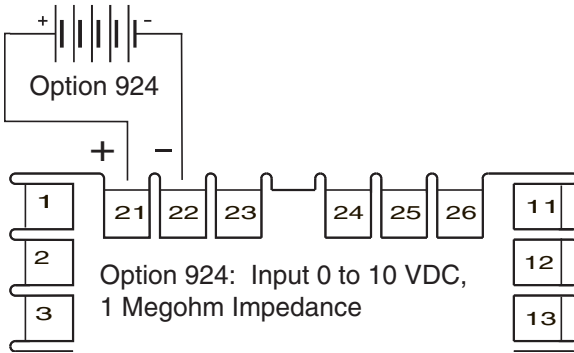

WIRING FOR OPTION 926 REMOTE SET POINT

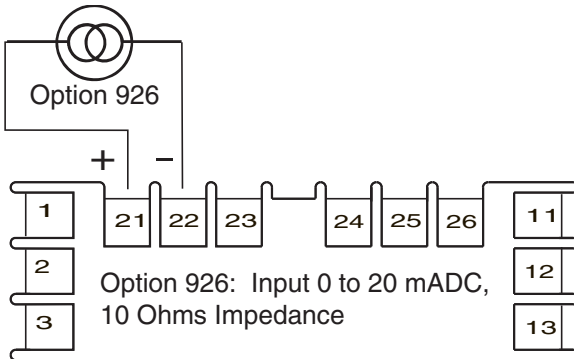



CAUTION: DO NOT RUN SIGNAL WIRING IN THE SAME CONDUIT OR CHASE AS THE POWER WIRING. ERRATIC OPERATION OR DAMAGE TO THE CONTROL CIRCUITRY WILL RESULT.

WIRING FOR OPTION 928 REMOTE SET POINT

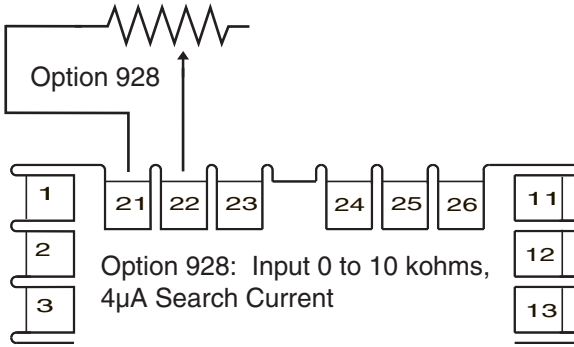

WIRING FOR OPTION 934 ANALOG RETRANSMISSION

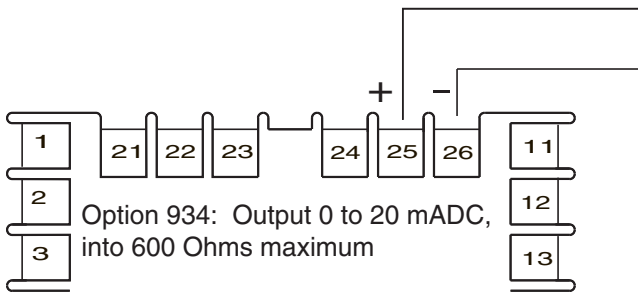

WIRING FOR OPTION 936 ANALOG RETRANSMISSION

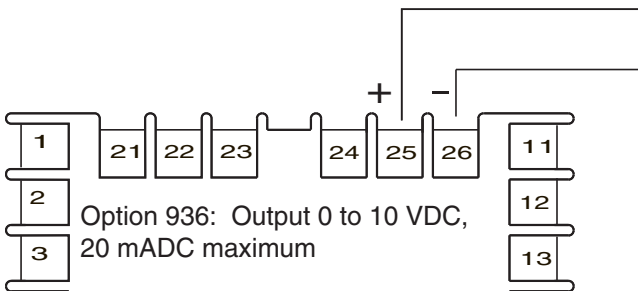



CAUTION: DO NOT RUN SIGNAL WIRING IN THE SAME CONDUIT OR CHASE AS THE POWER WIRING. ERRATIC OPERATION OR DAMAGE TO THE CONTROL CIRCUITRY WILL RESULT.

WIRING FOR OPTION 948 4-STAGE SET POINT



SWITCH CONTACTS FOR OPTION 948 MUST BE ISOLATED AND CAN NOT SHARE WIRING WITH OTHER CONTROLS.



TRANSISTOR DRIVE MUST BE ISOLATED AND MAY NOT SHARE A COMMON GROUND WITH OTHER EQUIPMENT OR OTHER CONTROLS.

Option 948

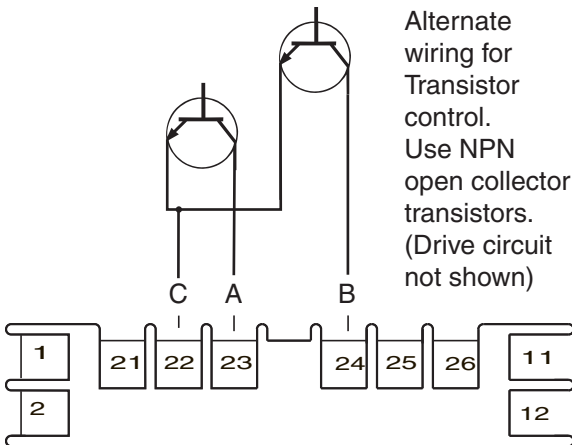
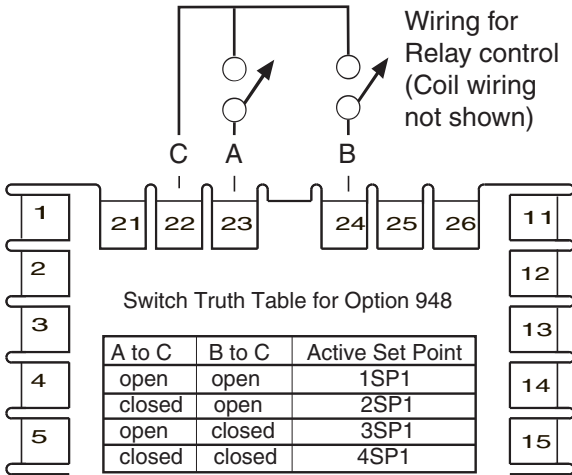



CAUTION: DO NOT RUN SIGNAL WIRING IN THE SAME CONDUIT OR CHASE AS THE POWER WIRING. ERRATIC OPERATION OR DAMAGE TO THE CONTROL CIRCUITRY WILL RESULT.

WIRING FOR OPTION 992, 993, 995, 996 SERIAL COMMUNICATIONS

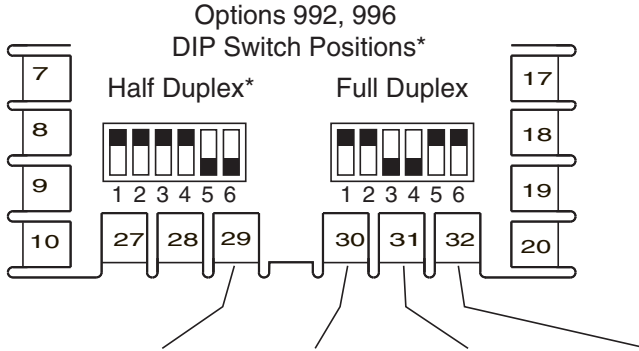

Terminal	29	30	31	32
Options 992, 996	Y (receive -)	Z (receive +)	A (transmit -)*	B (transmit +)*
Options 993, 995	not used	data out	data ground	data in

*For half-duplex operation wire only A and B. Do not connect to Y and Z.

DB-25 WIRING
(VIEWED FROM WIRE SIDE)

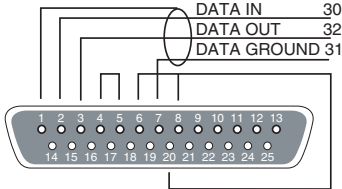

PIN	DESCRIPTION	PIN	DESCRIPTION
1	SHIELD	6	DSR
2	TRANSMIT	7	GROUND
3	RECEIVE	8	DCD
4	RTS	20	DTR
5	CTS		

RS-232 DB-9 WIRING
(VIEWED FROM WIRE SIDE)

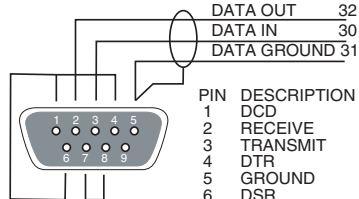





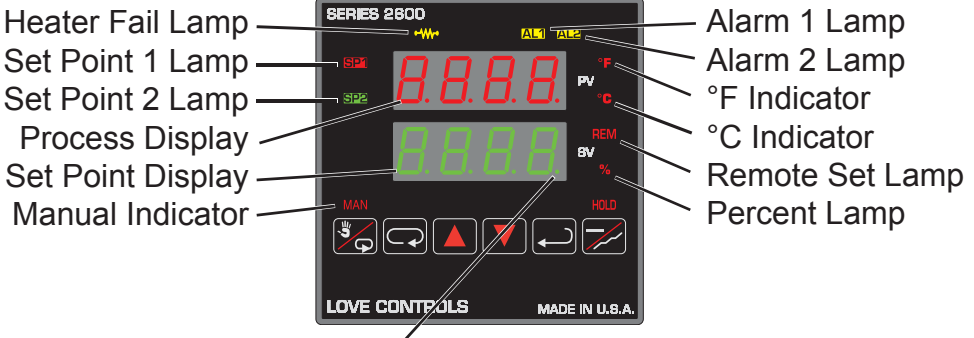







PIN	DESCRIPTION
1	DCD
2	RECEIVE
3	TRANSMIT
4	DTR
5	GROUND
6	DSR
7	RTS
8	CTS

FRONT PANEL KEY FUNCTIONS



The decimal point flashes when Self Tune is operating.

-  **INDEX:** Menu Navigation. Pressing the  INDEX key advances the display to the next menu item. May also be used in conjunction with other keys as noted below.
-  **UP ARROW:** Increments a value, changes a menu item, or selects the item to ON. The maximum value obtainable is 9999 regardless of decimal point placement.
-  **DOWN ARROW:** Decrements a value, changes a menu item, or selects the item to OFF. The minimum value obtainable is -1999 regardless of decimal point placement.
-  **ENTER:** Pressing  ENTER stores the value or the item changed. If not pressed, the previously stored value or item will be retained. The display will flash once when  ENTER is pressed.
-  **AUTO/MANUAL:** This key toggles the control output between Automatic mode and Manual mode. Press and hold key for three seconds to activate. See section on AUTO/MANUAL operation on page 18.
-  **RUN/HOLD:** This key toggles the Ramp/Soak program functions between Run mode (program runs as set up), and Hold mode (program functions are suspended). Press and hold key for three seconds to activate. See section on Ramp/Soak (page 15) for further details.
-  **UP ARROW & ENTER:** Menu Access. Pressing these keys simultaneously brings up the secondary menu starting at the alarm, tune, or cycle item (depending on programming). Pressing these keys for 5 seconds will bring up the secure menu.
-  **INDEX & DOWN ARROW:** Menu navigation. Pressing these keys simultaneously will allow backing up one menu item, or if at the first menu item they will cause the display to return to the primary menu.
-  **INDEX & DOWN ARROW:** Alarm Reset. If an alarm condition has occurred, press and hold these keys for three seconds to reset the alarm. Note that the alarm condition will not reset if the alarm condition still exists.
-  **INDEX & ENTER:** 'Global Reset'. Pressing these keys simultaneously and holding them for 5 seconds forces a 'warm boot', restarting the control (similar to turning power off and on). 'Global Reset' will allow recovery from errors and reset the following menu items:

AL iH: Alarm inhibit





OPEn InP: Input error message

bAd InP: Input error message



CHEC CAL: Check calibration error



Correct the problems associated with the above conditions before using these reset keys. More than one error could be present. Caution is advised since several items are reset at one time.

While in the **Primary** or **Secondary Menu**, if no key is pressed for a period of 30 seconds, the display will return to the HOME position displaying the temperature value. While in the **Secure Menu**, if no key is pressed for a period of 60 seconds, the display will return to the HOME position displaying the temperature value. Outputs are disabled (turned off) when the **Secure Menu** is active.

NOTE: To move to the **Primary Menu** quickly from any other menu, press the   **UP ARROW & ENTER** keys followed by pressing the   **INDEX & DOWN ARROW** keys.

SECURITY LEVEL SELECTION

Four levels of security are provided. The display shows the current security level. To change security levels change the password value using the  **UP ARROW** and  **DOWN ARROW** keys and press the  **ENTER** key. Refer to the password table (following) for the correct value to enter for the security level desired. The **SECF** menu item security level may be viewed or changed at any time regardless of the present security level.

To set the access level to, for example, 2, at the **SECF** menu item press the  **UP ARROW** key until the upper display shows the password for level 2 access, 1101. Press the  **ENTER** key. The display will blink and return with the level value, 2, in the upper display.

The password values shown in the table cannot be altered, so retain a copy of these pages for future reference. This is the only reference made to password values in this instruction book.

PASSWORD TABLE

Security Level		Displayed Value When Viewed	Password Value To Enter
Menu	Status		
Primary	Locked	1	1110
Secondary	Locked		
Secure	Locked		
Primary	Unlocked	2	1101
Secondary	Locked		
Secure	Locked		
Primary	Unlocked	3	1011
Secondary	Unlocked		
Secure	Locked		
Primary	Unlocked	4	111
Secondary	Unlocked		
Secure	Unlocked		

NOTATION CONVENTIONS FOR THE MENUS

Because of the number of features available in this control, information is included that may not apply to your specific control. All usable features are included in this book, but may not be used in your process. To increase clarity the following conventions are used:

1. Certain features, menu items, and functions shown in this book may or may not appear on your control, depending on other menu item selections. At various places in the menus there are notes identifying menu items that “control” or “direct” other menu items. If you are looking for a particular menu item and can’t find it, check the menu item that is its “control” for proper setting.
2. The “#” symbol is used in two ways. It is used inside a group of characters to indicate which set point function (SP1 or SP2) is being affected. It is also used before a group of characters of a menu item to indicate that there may be more than one selection or value for that menu item. This is used for certain repeated items such as in the Ramp/Soak Program section.

DISPLAY CONVENTIONS

The instrument front has two four digit displays, eleven indicators, and six keys. The diagram on page 12 shows the location of the displays and descriptors.

During normal operation the top four digit display indicates the temperature that is being read by the sensor. The bottom display indicates the set point. When you are programming the instrument, the bottom display indicates the Menu Item being programmed and the top display the value selected for that Menu Item. Error messages use both the top and bottom displays to indicate a particular error.

Each character can only be displayed with seven light segments. Alphabet characters may look peculiar when seen presented this way. The following is an example of the ‘seven segment alphabet’ as used in the instrument:



A	B	C	D	E	F	G	H	I	J	K	L	M	N	O	P	Q	R	S	T	U	V	W	X	Y	Z
a	b	c	d	e	f	g	h	i	j	k	l	m	n	o	p	q	r	s	t	u	v	w	x	y	z
0	1	2	3	4	5	6	7	8	9																
0	1	2	3	4	5	6	7	8	9																

Notice that some characters are in upper case while others are in lower case. Some look the same (e.g. G [g] and 9 [9]) and must be interpreted by context. Others are close (e.g. B [b] and 6 [6]), but different. Usually, the context of the term or value will help you determine the correct character.

THE HOME DISPLAY

The home display is the normal display while the control is operating. If no errors or functions are active, the HOME display will indicate the Process Variable (the temperature, pressure, flow, RH, etc., that is being measured) on the top display and the Set Variable (Set Point 1) on the bottom.

Items that can change the HOME display are the Auto/Manual function, the Run/Hold function, the $P_{R\Delta}$ function, the $P_{C+\Delta}$ function, and any error message. Description of these special displays follows.

If the  Auto/Manual key is pressed, the Manual indicator lights, the “%” indicator lights, and the home display is changed. The upper display continues to show the Process Variable (PV), but the lower display changes to show the percentage of output in tenths of a percent to 99.9% (0.0 to 99.9), or 100 if 100%. The display digit to the right of the number shows a flashing letter δ to indicate that the value displayed is no longer the SV, but percent output. The SP_2 percent output is indicated by the use of an overline on the letter δ . Access to the SP_2 value is made by the  INDEX key. See Auto/Manual Operation on Page 17 for further information.

If $P_{R\Delta}$ is turned Δ , the HOME display changes the SV display from SP_1 to the Present Set Variable as calculated by the Ramp/Soak Programmer function. See Programming and Operation for Ramp/Soak Feature below for more information.

If $P_{C+\Delta}$ (Secondary Menu) is turned Δ , the lower display changes to show the active percentage of output as required to maintain SP_1 . The display is similar to the Auto/Manual display above, except that the percent indicators ($\delta, \bar{\delta}$) do not flash, and the output is displayed in whole percentages of output, not in tenths of a percent. If the control has both SP_1 and SP_2 , the lower display will alternate between the SP_1 percent output and the SP_2 percent output.

Error messages are listed on pages 41-43.

PROGRAMMING AND OPERATION FOR RAMP / SOAK FEATURE

The ramp / soak feature offers a great deal of flexibility by allowing changes in the set point to be made over a predetermined period of time. Dwell times can be programmed, and the alarm output relay can be programmed to open or close during any of the segments.

Theory of Operation

The 2600 Series controls offer a very simple approach to programming a ramp. Rather than requiring the operator to calculate an approach rate (usually in degrees per minute), the 2600 does the calculation internally. Thus, the operator only needs to program the target set point and the time desired to reach that point. When the ramp segment is executed by the control, it calculates the ramp required to move the process from the starting value (current PV) to the desired value (programmed SP) in the time allowed.



Soaks (or dwells) are ramp segments where the target set point is the same as the beginning process value. This allows for multistage ramps without wasting intermediate soak steps. Care must be taken, however, that the process does actually reach the soak value before the soak time starts. If not, the next segment will calculate a slope from the starting PV to the target SP. Depending on your process requirements, this difference may be important. Make sure to test any program for desired results before running production material.

Do not operate Self Tune while a ramp function is operating. The ramp function will prevent the Self Tune from operating properly. Make sure that all tuning is set up before operating Ramp / Soak.

Program Setup

All of the programming for the Ramp / Soak function is done in the Secondary Menu. You may wish to work out your program on paper before going into the programmer menu sequence.

In the Secondary Menu  INDEX to `PROG` and make sure that `PROG` is set to `OFF`.



 INDEX to `PSE+` and turn `On`. Press  ENTER.

Skip the `STAR+` setting (this is discussed later) and press  INDEX to `1+i`.

The following items repeat in the following order: `1+i`, `1SP`, `1A1` and/or `1A2` (if `AL1` or `AL2` in the Secure Menu are programmed set to `EUOn+`), `2+i`, `2SP`, `2A1`, ..., `1b+i`, `1bSP`, `1bA1`, `1bA2`. To avoid repetition each item will only be described once.

Set `1+i` to the amount of time you want for the first ramp. This value is in time units (determined by the `+bA5` menu item) from `0` to `9999`. Press  ENTER.

Set `1SP` to the target value desired for the first ramp. This value is in actual units just like `SP1`. If the control is programmed for temperature, then the SP displays are in temperature. If the control is programmed for some other engineering unit, the SP is set in that unit.

Press  INDEX to continue. If Alarm 1 is programmed as an event (`AL1 = EUOn+`), then `1A1` will appear. If you wish the Alarm 1 contact to function for this segment, set `1A1` for `On`. If not, set for `OFF`. Press  ENTER. When `1A1` is set to `On`, the Alarm 1 function will be active for the entire period set in `1+i` above.





Complete setting the segment times (`2+i` ... `1b+i`), segment set points (`2SP` ... `1bSP`), and event alarms (`2A1` ... `1bA1`) to `On` or `OFF`.

For unneeded or unused segments set the segment times (`2+i` ... `1b+i`) to `0`, and set the segment set points (`2SP` ... `1bSP`) to the same value as the last active set point. A segment alarm may be set to indicate "end of run" at the segment number you select.

The last menu item for the ramp / soak function is PE_{nd} . PE_{nd} determines what the control does when the program has ended. You may choose to have the program repeat ($Loop$), Hold the last set point ($lbSP$), revert to the local $SP1$, or turn the outputs off (OFF).

It is important to remember that if you want the program to repeat, you must allow the process to return to the same condition that existed when the program first started. Remember that the ramp function calculates the slope by drawing a line from the beginning PV to the ramp target set point. If the PV at the end of the program is different than the PV at the initial start, the ramp will calculate differently.

Ramp / Soak Operation

When you wish to start the program, enter the Secondary Menu and set the $Prog$ menu item to On . Return to the HOME position by waiting for the display to time out or by pressing the   UP ARROW & ENTER keys and then the   DOWN ARROW & INDEX keys.

The home display will read as it normally does. The HOLD indicator by the RUN / HOLD key will be lit. To start the program press the  RUN / HOLD key for three seconds. The HOLD indicator will go out, and the program will start.

To suspend the program at any time, press the  RUN / HOLD key. Press the key again to resume.

Pressing the  AUTO / MANUAL key will also suspend the program operation. The difference is that AUTO / MANUAL also puts the control into manual mode. See Auto / Manual Operation on page 18.

The function of the Primary Menu will change depending on the setting of the $S+R+$ menu item in the Secondary Menu. If $S+R+$ is OFF then the Primary Menu is not changed.

If the $S+R+$ menu item is set to On , then the Primary Menu has three additional information items added before $SP1$ appears. The first INDEX item displays the time remaining in the current segment in the top display (####), and the message $+i$, in the lower display. The next INDEX item displays the total time for the active segment in the upper display (####) and the message $##+i$ ($1+i...lb+i$), in the lower display. The third INDEX item displays the segment set value (####) in the top display, and the message $##SP$ ($ISP...lbSP$) in the lower display. The next INDEX press resumes the normal Primary Menu

AUTO / MANUAL OPERATION

The AUTO / MANUAL function allows you to manually adjust the output of the control. This is normally used during process setup or start up. It can also be used for troubleshooting. To switch from AUTO to MANUAL press the  AUTO / MANUAL key and hold for three seconds. The MANual indicator will light and the lower display will change from normal to showing the actual output in percent. The value will be the actual percentage of output that was active when the key was pressed. This is usually known as “bumpless transfer”.

If you wish to change the output while in manual, press the UP ARROW or DOWN ARROW keys to change the value, and press ENTER to retain it. It is important to remember that the value of the display is read as 0 to 100% of the full control output, NOT the range between S1OL and S1OH or S2OL and S2OH. For example, if the set point one output is programmed for 4 to 20 mA (S1OL=20, S1OH=100), a reading of 50% in MANUAL represents 10 mA, not 12 mA. This allows the operator to go above and below the output range to allow for improperly function equipment that may be connected to the control output.

To return to AUTOMATIC control, press the  AUTO / MANUAL key again. The MANual indicator will go out, and the set point will take over. However, if you want bumpless transfer back to AUTO, slowly change the percentage of output until the process variable matches (or at least is close) to the set point. The further away the PV is from the set point, the greater the “bump” or upset there will be in the output.

SELF TUNE FUNCTION

Self Tune allows automatic selection of the necessary parameters to achieve best control operation from your 2600 Series control. If you are using the control output as a simple on-off function (Q_{u+1} set for Q_{nDF}), none of the following will apply.

Theory of Operation

The Self Tune function calculates the P_{bl} , r_{ES} , and r_{tE} parameters under the $P_{id} + u_{nE}$ selection, and the F_{bnd} and F_{r+E} parameters, as shown in the Secondary Menu. These values are determined by measuring the response of the process connected to the control. When Self Tune is started, the control temporarily acts as an on-off control. While in this mode the control measures the overshoot and undershoot of the process, and the period of the process (the time from peak value to the next peak value). These measurements are collected over a period that lasts three periods of overshoot and undershoot. The data collected over this time is then compared and calculated into final PID and Fuzzy Logic values. The effect of Fuzzy Logic on the process is still controlled by the F_{int} (fuzzy intensity) setting. If F_{int} is 0, the F_{bnd} and F_{r+E} will be calculated, but will have no effect. The calculations for the PID values are the same as used in the standard Ziegler - Nichols equations that have been recognized as standard for decades.

The only modification to the application of the Ziegler - Nichols equations is controlled by the $dFRC$ menu item. This menu item controls the amount of rate (derivative) that is applied. A $dFRC$ setting of 3 (factory default) or less allows for less damping. A $dFRC$ setting of 4 allows for critical damping as set forth in Ziegler - Nichols. A $dFRC$ setting of 5 or more allows over damping of the process.

Program Setup and Operation

Do not cool the process or add heat while the tuning is occurring. In the secondary menu set `tUNE` to `SELF`. Skip `LErn` and check to make sure that `dFAC` is set to the desired value. Back up to `LErn` and set to `YES`. The control will begin the Self Tune function. While the Self Tune function is active, the right hand decimal point on the lower display will blink. When Self Tune is complete, the blinking will stop.

After Self Tune is complete, the `tUNE` setting automatically switches to `PID`. This allows examination and / or modification of the values calculated. We recommend that you do not change the calculated values unless you have a firm understanding of the parameters involved and their function.

OPERATION AND PROGRAMMING OF OPTIONS

Options 924, 926, 928, Analog Remote Set Point

The analog remote set point allows the control set point to be determined by an outside analog signal. The signal may be 0 to 10 VDC (Option 924), 0 (or 4) to 20 mADC (Option 926), or 0 to 10,000 Ohms (Option 928).

Wire the input as shown on pages 8 and 9.

To set up the analog remote set point, first determine the scale range that the analog signal will represent. The maximum span is 11,998 degrees or counts. In the Secure Menu set `rSCL` for the scale value that will be represented by the low end of the analog signal (0 Volts, 0 mA, 0 Ohms). Set `rSCH` for the scale value that will be represented by the high end of the analog signal (10 Volts, 20 mA, 10,000 Ohms).

If you require a suppressed scale or input, use the following equations to determine the proper settings for `rSCL` and `rSCH`.

$K = (\text{Highest desired scale reading} - \text{Lowest desired scale reading}) / (\text{Maximum desired analog signal} - \text{Minimum desired analog signal})$.

$rSCH = ((\text{Maximum possible analog signal} - \text{Maximum desired analog signal}) * K) + \text{Highest desired analog reading}$.

$rSCL = \text{Lowest desired scale reading} - ((\text{Minimum desired analog signal}) * K)$.

Make sure that a valid analog signal is available to the control. In the Secondary Menu set the `rSP+` to `On`. The REM indicator on the front of the control will turn on. When the control returns to the HOME position, the displayed SV will be the value supplied from the analog remote signal. If the analog remote signal fails or goes out of range of the `SPL` or `SPH` settings, the control will revert to the internal `SP1` (or `#SP1`), and flash the error message `CHec rSP+`. If `SPL` or `SPH` are set outside of `rSCL` or `rSCH` then the error will be suppressed, and the control will attempt to work with the remote value.

To clear the error message, change `rSP+` to `OFF`.

Option 934, 936, Isolated Analog Retransmission.

The analog retransmission option allows the Process Variable or the Set Variable to be sent as an analog signal to an external device. The signal may be either 0 to 10 VDC (Option 936) or 0 (or 4) to 20 mA DC (Option 934). The output may be changed in the field from one to the other by the toggle switch located on the top printed circuit board.

Wire the output as shown on page 9.

To set up the analog retransmission, first determine the scale range that the analog signal will represent. The maximum scale is 9999°F, 5530°C, or 9999 counts. In the Secondary Menu set P_{OL} for the scale value that will be represented by the low end of the analog signal (0 Volts or 0 mA). Set P_{OH} for the scale value that will be represented by the high end of the analog signal (10 Volts or 20 mA).

If you require a suppressed scale or output, use the following equations to determine the proper settings for P_{OL} and P_{OH} .

$K = (\text{Highest desired scale reading} - \text{Lowest desired scale reading}) / (\text{Maximum desired analog signal} - \text{Minimum desired analog signal}).$

$P_{OH} = ((\text{Maximum possible analog output} - \text{Maximum desired analog signal}) * K) + \text{Highest desired analog reading}.$

$P_{OL} = \text{Lowest desired scale reading} - ((\text{Minimum desired analog output}) * K).$

Next select whether you want the retransmission signal to follow the Process Variable or the Set Variable. Usually the Process Variable is sent to recorders or other data acquisition devices. Usually the Set Variable is sent to other controls to be used as an analog remote set point. If you want the analog retransmission signal to follow the PV, in the Secondary Menu set P_{OSr} to I_{nP} . If you want the analog retransmission signal to follow the SV, set P_{OSr} to S_{P+} .

Operation is automatic. There are no further programming steps required.

Option 948, 4-Stage Set Point.

The 4-stage set point option allows four different values to be used for $SP1$ and all of the values associated with the $TURN$ menu items. The control will switch to a given stage when an external contact or contacts are made or opened across the appropriate terminals at the rear of the control ($SP5A$, Set Point Switch Action, set for remote, rE), or when the stage is selected from the Secondary Menu, SP (when $SP5A$ is set for $ln+$). When the state of a contact changes (or the stage number is changed in the Secondary Menu), the values in use are stored and the previously stored values for the new stage are used.

Wire the input as shown on page 10.

Usually the control is configured for external switching of the stages. In this case, the operation is usually automatic, selected by the external switches driven by the machine logic. If it is necessary to program the stages in advance, you may select the stage to modify with the SP menu item. When SP is changed while the $SP5A$ is set for rE , the selected stage is displayed for modification, but only used when the appropriate contact is made.

Option 992, 993, 995, 996 Serial Communication.

The serial communications options allow the control to be written to and read from a remote computer or other similar digital device. Communication is allowed either through a RS-485 (Option 992, 996) port, or a RS-232 (Option 993, 995) port.

Wire the communication lines as shown on Page 11. Wiring for the RS-485 is run from control to control in a daisy chain fashion with a termination resistor (120 ohms) across the transmit and receive terminals of the last control in the chain.

Select the control address and communication baud rate with the $ADDR$ and $BAUD$ menu items in the Secure Menu.

NOTE: THE BAUD RATE AND ADDRESS MENU ITEM SETTINGS WILL TAKE EFFECT ON THE NEXT POWER UP OF THE CONTROL. BE SURE TO TURN THE POWER TO THE CONTROL OFF AND ON BEFORE USING THE NEW BAUD RATE AND ADDRESS VALUES.

In operation, you have the option of preventing a write command from the host computer. To prevent the host from writing to the control change the $LOCK$ menu item in the Secondary Menu to LOC . To allow the host to write commands to the control set $LOCK$ to rE . (The host does have the ability to change the $LOCK$ state, but it is not automatic.)

If your system depends on constant reading or writing to and from the host, you may wish to set the No Activity Timer ($nA+$) to monitor the addressing of the control. When the $LOCK$ is set to rE and the $nA+$ is set to any value other than OFF , the control will expect to be addressed on a regular basis. If the control is not addressed in the time set by the value of $nA+$, then the control will display the error message $CHEC LOCK$. To clear the message set $LOCK$ to LOC .

SERIAL COMMUNICATIONS OPTIONS AND NONVOLATILE MEMORY

There are many different types of memory used in computer driven devices. The terms RAM (random access memory) and ROM (read only memory) are a couple with which you may be familiar.

RAM is used in computers to run programs and hold data for a short period of time. This is the memory that is used primarily in PCs. RAM is very fast and can be read and written to over and over again. Its major weakness is that it is erased when the power is turned off.

ROM is used in computers to hold the 'permanent' programming that allows a PC to start. This memory is 'burned in' to the chip itself and can not be changed. Unlike RAM, however, this memory is permanent. While it can not be changed, it can not lose its programming when power is turned off. This is the type of memory that is used to store the permanent programming for the control.

There is a third type of memory that is now currently used to combine the characteristics of both RAM and ROM. This is known as EEPROM (electrically erasable programmable read only memory). While the name may be long and somewhat cryptic, the EEPROM can be erased and re-written many times, and yet hold the programmed data even over long periods when the power is off. This is the type of memory that Love Controls uses to save the settings you program in your control. The reliability and longevity of the data retention is what allows us to guarantee a 10 year data retention without power.

In normal operation, the control uses RAM, just as any other computerized device. Whenever you make a change to one of the parameters in the control, the set point for example, the new value is written into the EEPROM. This way, if power goes off for whatever reason, when power resumes, the latest settings are preserved. When power is turned on, the data is copied from the EEPROM to the RAM to restore operation.

You might ask, "If EEPROM is such a wonderful thing, why bother with RAM?" One reason is that is that RAM is much faster than EEPROM. Faster speed gives you better performance in critical control functions.

Perhaps the most important reason is that RAM allows an unlimited number of writes, while EEPROM has a limit to the number of times that it can be erased and re-written. Current technology now sets that limit at about one million erase / write cycles. In a dynamic control situation, it may be necessary to update RAM every few milliseconds. EEPROM can not keep up to that pace, and, even if it could, it would be 'used up' in a matter of days.

If you think about how long it would take to make a million changes to the control programming through the front key pad, you will see that it would take a very long time to get to use up the life of the EEPROM.

Adding one of the computer communications options (e.g. 992, 993, 995, 996) changes the picture. The speed of computer communications is such that hundreds of instructions can be made in less than a minute. In such a situation, the million erase / write cycles could be used up in a couple of months causing the chip (and the control) to fail.

Usually in such a situation, the control is under close observation by the host computer. It may not be necessary, then, to have the data written to the EEPROM, as it is 'transitory' in nature (changing set points for a ramp/soak sequence for example).

Controls equipped with a Serial communications option have a menu item in the Secure menu (5+0r) that allows the serial communications to write to RAM (5+0r = 00).





The factory default is 'write to EEPROM' (5+0r = 9E5).

If your computer system will be making frequent changes to the control, we strongly recommend that you select the 'write to RAM' parameter (5+0r = 00). If you are primarily reading from the control, there is no need to change the setting.

For further information on protocols and technical information regarding computer programming for the Serial Communications options, see our web site at <http://www.love-controls.com/protocol>.

MENU SELECTIONS

PRIMARY MENU

Press  **INDEX** to advance to the next menu item. Press  **UP ARROW** or  **DOWN ARROW** to change the value in the display. Press  **ENTER** to retain the value. If 5+R+, (Secondary Menu), is 00, the three program status menu items shown on Page 17 will precede the following.

- #SP1 (Option 948, 4-Stage Set Point) or
- SP1 Set Point 1 Adjust, Control Point 1.

- SP2 Set Point 2 Adjust (if equipped), Control Point 2.

SECONDARY MENU

Hold **▲** **↶** **UP ARROW & ENTER**. Press **↷** **INDEX** to advance to the next menu item. Press **▲** **UP ARROW** or **▼** **DOWN ARROW** to change the value in the display. Press **↶** **ENTER** to retain the value.

If your instrument is not equipped with alarms (third character of part number is '0'), the Secondary Menu starts with **0u+1**, below.

- RLLo** Alarm 1 Low: The Low Alarm point is usually set below the Set Point. May not appear depending on **RL1** setting in Secure Menu.
- RLHi** Alarm 1 High: The High Alarm Point is usually set above the Set Point. May not appear depending on **RL1** setting in Secure Menu.
- RLLo** Alarm 2 Low: The Low Alarm point is usually set below the Set Point. May not appear depending on **RL2** setting in Secure Menu.
- RLHi** Alarm 2 High: The High Alarm Point is usually set above the Set Point. May not appear depending on **RL2** setting in Secure Menu.
- 0u+1** Output selection: Select **OnOff**, **#tP**, **#PUL**, or **PrOP**.
- OnOff** A setting of **OnOff** allows the control to operate in simple on/off mode. This setting forces the control to turn off at set point, and on at the set point plus the differential (**SP1d**). When selected, the **0u+1 OnOff** menu item is followed by **#### SP1d**, and the **tUNE**, **Pb**, **rES**, **OFFS**, and **r+E** selections in the Secondary menu and the **S10L** and **S10H** selections in the Secure menu are suppressed.
- SP1d** Set Point On-Off Differential (hysteresis). Set for the amount of difference between the turn off point and the turn on point. Select 1 to 9999 (direct acting), or -1 to -9999 (reverse acting). This value will be negative for reverse acting set points, and positive for direct acting outputs. The following drawing shows output behavior for reverse and direct action. For reverse action note how the output decreases as the input process variable increases, e.g. heat power goes to zero as the temperature increases to set point.

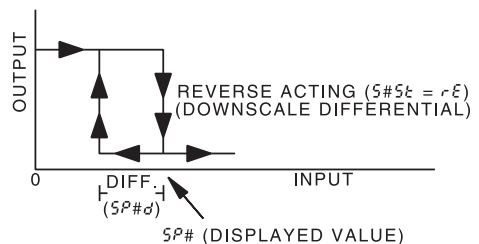
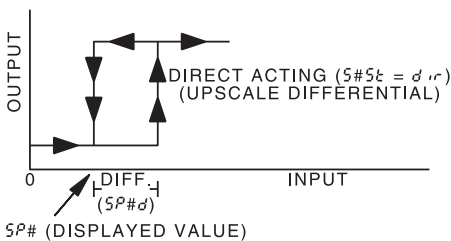

- ##+P** Time Proportioning Cycle Time. Select 1+P to 80+P.
 1+P A setting of 1+P is recommended for solid state outputs (SSR or 15 VDC).
 2+P to 80+P Time Proportioning Control is adjustable in 1 second steps. Recommended for mechanical outputs (relays, solenoids, etc.). For best contact life, a time should be selected as long as possible without causing the process to wander.
- #P_{UL}** Pulsed Time Proportioning Output: Select 1P_{UL} to 7P_{UL}. 1P_{UL} = Linear and 7P_{UL} = most nonlinear. Changes output linearity for use in cooling applications or for extremely fast response processes. At the center of the proportional band, a pulse value of 1 provides an output of one second on and one second off (50% output). A pulse value of 2 provides an output of one second on and two seconds off (33% output). Output at center of band equals one second on, 2^(pulse value-1) seconds off.
- P_{roP}** For Current (Code 5) outputs only.

The following menu items apply only if your control is equipped with a second set point (last digit of model number is not zero). If your control does not have a second set point, jump to the **t_{unE} menu on the next page.**

- 0_{u+2}** Output selection: Select 0_{nOF}, #+P, #P_{UL}, or P_{roP}.
- 0_{nOF}** A setting of 0_{nOF} allows the control to operate in simple on/off mode. This setting forces the control to turn off at set point, and on at the set point plus the differential (SP_{2d}). When selected, the 0_{u+2}/0_{nOF} menu item is followed by ##### SP_{2d}, and the P_{b2} selection in the Secondary menu and the S_{2OL} and S_{2OH} selections in the Secure menu are suppressed.
- SP_{2d}** Set Point On-Off Differential (hysteresis). Select 1 to 9999 (direct acting), or -1 to -9999 (reverse acting). See SP_{1d} on the previous page.
- ##+P** Time Proportioning Cycle Time. Select 1+P to 80+P.
 1+P A setting of 1+P is recommended for solid state outputs (SSR or 15 VDC).
 2+P to 80+P Time Proportioning Control is adjustable in 1 second steps. Recommended for mechanical outputs (relays, solenoids, etc.). For best contact life, a time should be selected as long as possible without causing the process to wander.

#PUL Pulsed Time Proportioning Output: Select 1PUL to 7PUL. 1PUL = Linear and 7PUL = most nonlinear. Changes output linearity for use in cooling applications or for extremely fast response processes. At the center of the proportional band, a pulse value of 1 provides an output of one second on and one second off (50% output). A pulse value of 2 provides an output of one second on and two seconds off (33% output). Output at center of band equals one second on, 2^(pulse value-1) seconds off.

ProP For Current (Code 5) outputs only.

SP (Option 948, 4-Stage Set Point) Active Set Point Stage. Select 1SP1, 2SP1, 3SP1, 4SP1. (See Page 21 for more detail.)

1SP1 Set Menu Items to display Stage 1 for view and change access. If SP5A is set for Int, 1SP1 is made active.

2SP1 Set Menu Items to display Stage 2 for view and change access. If SP5A is set for Int, 2SP1 is made active.

3SP1 Set Menu Items to display Stage 3 for view and change access. If SP5A is set for Int, 3SP1 is made active.

4SP1 Set Menu Items to display Stage 4 for view and change access. If SP5A is set for Int, 4SP1 is made active.

#SP1 (Option 948, 4-Stage Set Point) Adjust Control Point 1 for Stage selected above.

Note: The menu items for tUNE (below) are modified when Option 948 is active. Then, the menu items are shortened or shifted right, and preceded with the stage number selected in SP above. Each stage has its own set of tUNE parameters as indicated by #tUN.

#tUN (Option 948, 4-Stage Set Point) or

tUNE Tuning Choice: Select SELF, Pid, SLO, nor, or FASt.



SELF The Controller will evaluate the Process and select the PID values to maintain good control. Active for SP1 only.

LErn Select YES or no



YES Start Learning the Process. After the process has been learned the menu item will revert to no.

no Learning will stay in present mode.

dFAC	Damping factor, Select OFF, 1 to 7. Sets the ratio of Rate to Reset for the SELF TUNE mode. 7 = most Rate. Factory set to 3. For a fast response process the value should be lowered (less Rate). For a slower process the value should be increased (more Rate).
Pid	Manually adjust the PID values. PID control consists of three basic parameters, Proportional Band (Gain), Reset Time (Integral), and Rate Time (Derivative).
#Pb1	<i>(Option 948, 4-Stage Set Point)</i> or
Pb1	Proportional Band (Bandwidth). Select 1 to 9999 °F, °C, or counts.
Pb2	Proportional Band (Bandwidth). Select 1 to 9999 °F, °C, or counts. Appears only if control is equipped with second set point and OUT2 is NOT selected as ONOFF.
#rES	<i>(Option 948, 4-Stage Set Point)</i> or
rES	Automatic Reset Time. Select OFF, 0.1 to 99.9 minutes. Select OFF to switch to OFS.
#OFS	<i>(Option 948, 4-Stage Set Point)</i> or
OFS	Manual Offset Correction Select OFF, 0.1 to 99.9 percent. Select OFF to switch to rES.
#r+E	<i>(Option 948, 4-Stage Set Point)</i> or
r+E	Rate Time. Select OFF, 0.01 to 99.99 minutes, Derivative.
SLO	PID values are preset for a slow response process.
nor	PID values are preset for a normal response process.
FAS+	PID values are preset for a fast response process.
Pid2	Linkage of PID parameters between SP1 and SP2: Select ON or OFF.
ON	Applies SP1 rES, r+E, Fbnd, and Fr+E terms to SP2 for heat/cool applications.
OFF	SP2 functions without rES, r+E, Fbnd and Fr+E.
ARUP	Anti- Reset Windup Feature: Select ON or OFF.
ON	When ARUP is ON the accumulated Reset Offset value will be cleared to 0% when the process input is not within the Proportional Band.
OFF	When ARUP is OFF, the accumulated Reset Offset Value is retained in memory when the process input is not within the Proportional Band.







- R_{r+E}** Approach Rate Time: Select OFF, 0.01 to 99.99 minutes. The function defines the amount of Rate applied when the input is outside of the Proportional Band. The R_{r+E} time and the r_{r+E} time are independent and have no effect on each other. To increase damping effect and reduce overshoot set the approach rate time for a value greater than the natural rise time of the process (natural rise time = process value time to set point).
- F_{int}** Fuzzy Logic Intensity: Select 0 to 100%. 0% is OFF (disables Fuzzy Logic). The function defines the amount of impact Fuzzy Logic will have on the output.
- F_{band}** Fuzzy Logic Error Band: Select 0 to 4000 °F, °C, or counts. Sets the bandwidth of the Fuzzy Logic. Set F_{band} equal to PID proportional band (P_{b1}) for best results.
- F_{r+E}** Fuzzy Logic Rate of Change: Select 0.00 to 99.99 counts/second. For best initial setting, find the counts/second change of process value near Set Point 1 with output ON 100%. Multiply this value by 3. Set F_{r+E} to this calculated value.
- PEA** The Peak feature stores the highest input the control has measured since the last reset or Power On. At Power On PEA is reset to the present input. To manually reset the value PEA must be in the lower display. Press the  ENTER key to reset. PEA will be reset and display the present input value.
- VAL** The Valley feature stores the lowest input the Instrument has measured since the last reset or Power On. At Power On VAL is reset to the present input. To manually reset the value VAL must be in the lower display. Press the  ENTER key. VAL will be reset and display the present input value.
- P_{c+0}** Percent Output Feature: Select 0_n or OFF.
- 0_n When selected 0_n, the HOME lower display will indicate the output of the controller in percent. The “%” indicator lamp will light and an “o” will appear in the right hand side of the lower display to indicate percent output for SP1. An “a” will appear on the right hand corner of the lower display to represent percent output for SP2, if the control is so equipped. The display will alternate between these values.
- OFF Percent Output display is disabled.

- Prog** Ramp/Soak: Select **On** or **OFF**.
- On** Allows Programmed Ramp/Soak function to be started by the Run/Hold key on the control front panel.
 - OFF** Turns Ramp/Soak function **OFF** and resets program to beginning.
- PSE+** Programmer function set: Select **On** or **OFF**.
- OFF** Skip Ramp/Soak Programming. Go to next Secondary Menu Item, InPC (next page).
 - On** Enable Ramp/Soak Programming.
- S+R+** Programmer Status Display in the Primary Menu when Prog (above) is On: Select **On** or **OFF**.
- OFF** The Primary Menu operates as normal.
 - On** The Primary Menu is altered to have the following items inserted before the SP1 menu item:
 - #### **t_i** time remaining in active segment
 - #### **##t_i** total time in active segment
 - #### **##SP** segment target set point
- +bAS** Ramp/Soak Time Base: Select **1_5** or **60_5**.
- 1_5** Ramp/Soak time base is in 1 second increments. Program time **1t_i...1bt_i** is measured in seconds.
 - 60_5** Ramp/Soak time base is in 60 second increments (minutes). Program time **1t_i...1bt_i** is measured in minutes.
- The following items repeat in the following order: **1t_i**, **1SP**, **1A1** and **1A2** (if **AL1** is programmed as **EU_{n+}**), **2t_i**, **2SP**, **2A1**, **2A2**, ..., **1bt_i**, **1bSP**, **1bA1** **1bA2**,. To avoid repetition each item will only be described once.
- 1t_i** Segment Time: Select **0** to **9999** units (minutes if **+bAS** is set to **60_5**, seconds if **+bAS** is set to **1_5**).
- 1SP** Segment Set Point: Set to target value desired.
- 1A1** Segment Alarm 1 Event: Select **On** or **OFF**.
- On** Alarm 1 is active during segment 1 time (**1t_i**).
 - OFF** Alarm 1 is inactive during segment 1 time (**1t_i**).
- 1A2** Segment Alarm 2 Event: Select **On** or **OFF**.
- On** Alarm 2 is active during segment 1 time (**1t_i**).
 - OFF** Alarm 2 is inactive during segment 1 time (**1t_i**).
- PEnd** Program End action: Select **Hold** or **0oFF**.
- Hold** Stay at the Present Set Point (**1bSP**).
 - 0oFF** Turn Off SP1 and SP2 Outputs at the end of the program.
 - LooP** Repeat program starting at **1t_i**.
 - SP1** Revert to SP1 value.

- InPC** Input Correction: Select -500 to 0 to 500 °F, °C, or counts. This feature allows the input value to be changed to agree with an external reference or to compensate for sensor error. **Note:** InPC is reset to zero when the input type is changed, or when decimal position is changed. Factory default is 0.
- FiL+** Digital Filter: Select OFF, 1 to 99. In some cases the time constant of the sensor, or noise, could cause the display to jump enough to be unreadable. A setting of 2 is usually sufficient filtering (2 represents approximately a 1 second time constant). When the 0.1 degree resolution is selected this should be increased to 4. If this value is set too high, controllability will suffer.
- LPb-** Loop Break Protection: Select OFF, 1 to 9999 seconds. If, during operation, the output is minimum (0%) or maximum (100%), and the input moves less than 5°F (3°C) or 5 counts over the time set for LPb-, the LOOP bAd message will appear. This condition can also be routed to an Alarm Condition if alarms are present and turned On (see ALb- in the Secure Menu). The loop break error can be reset by pressing the  **ENTER** key when at the LPb- menu item. The  **INDEX** & **ENTER** keys may also be used.
- PQL** (Option 934, 936, Analog Retransmission Output) Process Output Low: Select -450°F, -260°C, or -1999 counts to any value less than PQH.
- PQH** (Option 934, 936, Analog Retransmission Output) Process Output High: Select from any value greater than PQL to +9999°F, +5530°C, or 9999 counts.
- POS-** (Option 934, 936, Analog Retransmission Output) Process Output Source: Select InP or SP+.
- InP Output follows the Process Variable (input).
 SP+ Output follows the Set Variable.
- rSP+** (Option 924, 926, 928, Analog Remote Set Point) Remote Set Point: Select On or OFF.
- OFF The control uses the value set for SP1.
 On The control uses the value set by the analog remote set point signal as established by the Secure Menu items rSCL and rSCH. If the analog signal fails, the control will display the error message CHEC rSP+ and revert to the SP1 local value.

- LOC** (Option 992, 993, 995, 996, Serial Communications) Local / Remote Status: Select **LOC** or **RE**. Does not affect other instruments on daisy chain.
- LOC** The host computer is advised that remote write commands will be rejected. Any write commands sent to this control will be rejected. All read commands are accepted.
- RE** The host computer is allowed to send write commands. If the control is not addressed within the time set in **NR+** (No Activity Timer in the Secure Menu) the **CHECK LOC/RE** error message will be displayed.
- Addr** (Option 992, 993, 995, 996, Serial Communications) Control Address: Display address from 1 to 3FF for Options 992 and 993. Display address from 1 to FF for options 995 and 996.. This number (hexadecimal, base 16) must match the address number used by the host computer. Not settable in this menu. To change this parameter, see **Addr** in the Secure Menu.

SECURE MENU

Hold   **UP ARROW & ENTER** for 5 Seconds. Press  **INDEX** to advance to the next menu item. Press  **UP ARROW** or  **DOWN ARROW** to change the value in the display. Press  **ENTER** to retain the value.

OUTPUTS ARE DISABLED (TURNED OFF) WHILE CONTROL IS IN SECURE MENU.

SEC Security Code: See the Security Level Selection and the Password Table in this manual, in order to enter the correct password.

InP Input Type: Select one of the following. Refer to the Wiring section for the proper wiring.

J-IC	Type "J" Thermocouple
CR	Type "K" Thermocouple
E-	Type "E" Thermocouple
+ -	Type "T" Thermocouple
L -	Type "L" Thermocouple
n -	Type "N" Thermocouple
r - 13	Type "R" Thermocouple
S - 10	Type "S" Thermocouple
b -	Type "B" Thermocouple
C -	Type "C" Thermocouple
P392	100 ohm Platinum (NIST 0.00392 $\Omega/\Omega/^\circ\text{C}$)
n120	120 ohm Nickel
P385	100 ohm Platinum (IEC/DIN 0.00385 $\Omega/\Omega/^\circ\text{C}$)
IP38	1000 ohm Platinum (IEC/DIN 0.00385 $\Omega/\Omega/^\circ\text{C}$)
Curr	DC Current Input 0.0 to 20.0 or 4.0 to 20.0 mA.
Volt+	DC Voltage Input 0.0 to 10.0 or 1.0 to 10.0 volts.
diff	DC Voltage Input -10 to +10 mV.
- - - -	Reserved

0SUP Zero Suppression: Select On or Off. Only with Current and Voltage input types.

Off The input range will start at 0 (zero) Input.

On The input range will start at 4.00 mA or 1.00 V.

Unit F, C or none.

F °F descriptor is On and temperature inputs will be displayed in actual degrees Fahrenheit.

C °C descriptor is On and temperature inputs will be displayed in actual degrees Celsius.

none °F and °C descriptors will be Off. This is only available with Current and Voltage Inputs.



dPt Decimal Point Positioning: Select , .0, .00, .000, or .0000. On temperature type inputs a change here will alter the Process Value, SP1, SP2, ALLO, ALHi, and InPC. For Current and Voltage Inputs all Menu Items related to the Input will be affected.

No decimal Point is selected. This is available for all Input Types.

.0 One decimal place is available for Type J, K, E, T, L, RTD's, Current and Voltage Inputs.

.00 Two decimal places is only available for Current and Voltage Inputs.

.000 Three decimal places is only available for Current and Voltage inputs.

- INP+** Input Fault Timer: Select OFF, 0.1 to 540.0 minutes. Whenever an Input is out of range (UFL or OFL displayed), shorted, or open, the timer will start. When the time has elapsed, the controller will revert to the output condition selected by INPb below. If OFF is selected, the Input Fault Timer will not be recognized (time = infinite).
- SEnC** Sensor Rate of Change: Select OFF, 1 to 4000 °F, °C, or counts per 1 second period. This value is usually set to be slightly greater than the fastest process response expected during a 1 second period, but measured for at least 2 seconds. If the process is faster than this setting, the SEnc bAd error message will appear. The outputs will then be turned off. This function can be used to detect a runaway condition, or speed up detection of an open thermocouple. Use the   **INDEX & ENTER** keys to reset.
- SCAL** Scale Low: Select 100 to 11998 counts below SCRH. The total span between SCAL and SCRH must be within 11998 counts. Maximum setting range is -1999 to +9999 counts. For Current and Voltage inputs, this will set the low range end. Value not adjustable for Thermocouple and RTD ranges.
- SCRH** Scale High: Select 100 to 11998 counts above SCAL. The total span between SCAL and SCRH must be within 11998 counts. Maximum setting range is -1999 to +9999 counts. For Current and Voltage inputs, this will set the high range end. Value not adjustable for Thermocouple and RTD ranges.
- SPL** Set Point Low: Select from the lowest input range value to SPH value. This will set the minimum SP1 or SP2 value that can be entered. The value for SP1 or SP2 will stop moving when this value is reached.
- SPH** Set Point High: Select from the highest input range value to SPL value. This will set the maximum SP1 or SP2 value that can be entered. The value for SP1 or SP2 will stop moving when this value is reached.
- SIS+** Set Point 1 State: Select dir or r-E.
- dir Direct Action. As the input increases the output will increase. Most commonly used in cooling processes.
 - r-E Reverse Action. As the input increases the output will decrease. Most commonly used in heating processes.

If 0_{u+1} (Page 19) is set for $\#\#+P$, $\#PUL$, or P_{rOP} , then $S10L$ and $S10H$ appear. If 0_{u+1} is set for 0_{nOF} , then skip to $S1rE$.



S10L Set Point Output Low Limit: Select 0 to 100% but not greater than $S10H$. This item limits the lowest output value. This is useful for adding a bias to the process when needed. Factory set to 0 for output codes 1 and 3. Factory set to 20 for output code 5 (20% output equals 4 mA output).

S10H Set Point 1 Output High Limit: Select 0 to 100% but not less than $S10L$ for output codes 1 and 3. Select 0 to 102% but not less than $S10L$ for output code 5. This item allows setting the maximum output limit. This is useful with processes that are over powered. Adjustment to 102% allows setting current output to force a full on condition for output devices which do not have bias adjustments. Factory set to 100 for all output codes.

If 0_{u+1} is set for $\#\#+P$, $\#PUL$, or P_{rOP} , then skip to $S1LP$ (next page).

If 0_{u+1} is set to 0_{nOF} (in the Secondary Menu), then the next three menu items can make the $SP1$ and $SP1d$ settings act like a high or low alarm set point. See the information on alarm settings and the cautions and warnings that apply to them on Pages 36-37.

Note that when Set Point 1 Power Interrupt, $S1Pi$ is 0_n , and Set Point 1 Reset, $S1rE$, is programmed to H_{oLd} , the $SP1$ output will automatically reset upon a power failure and subsequent restoration, if the process is below $SP1$.

S1rE Set Point 1 Reset. Select 0_{nOF} or H_{oLd} .
 0_{nOF} Output will automatically reset when process passes back through $SP1d$.
 H_{oLd} Manual Reset. Reset (acknowledge) by simultaneously pressing the   **INDEX & DOWN ARROW** keys for 3 seconds.

S1Pi Set Point 1 Power Interrupt. Select 0_n or 0_{FF} .
 0_n Alarm Power Interrupt is 0_n . Output will automatically reset on power-up if no alarm condition exists.
 0_{FF} Alarm Power Interrupt is 0_{FF} . Output will be in the alarm condition on power-up regardless of condition of process.

S1iH Set Point 1 Inhibit: Select 0_n or 0_{FF} .
 0_n Alarm Inhibit is 0_n . Alarm action is suspended until the process value first enters a non-alarm condition.
 0_{FF} Alarm Inhibit is 0_{FF} .

S1LP Set Point Lamp: Select 0_{oN} or 0_{oFF} .
 0_{oN} Lamp ON when Output is ON.
 0_{oFF} Lamp OFF when Output is ON.

If your control is not equipped with Set Point 2, then proceed to the alarm section (next page).

- 52+ Set Point 2 type: Select `Ab5` or `dE`.
- `Ab5` Absolute `SP2`. `SP2` is independent of `SP1`, and may be set anywhere between the limits of `SPL` and `SPH`.
 - `dE` Deviation `SP2`. `SP2` is set as a deviation from `SP1`, and allows `SP2` to retain its relationship with `SP1` when `SP1` is changed (`SP2` tracks `SP1`).
- 525+ Set Point 2 State: Select `dir` or `rE`.
- `dir` Direct Action. As the input increases the output will increase. Most commonly used in cooling processes.
 - `rE` Reverse Action. As the input increases the output will decrease. Most commonly used in heating processes.



If `0u+2` is set for `##+P`, `#PUL`, or `PrOP`, then `520L` and `520H` appear. If `0u+2` is set for `0nOF`, then skip `520L` and `520H`.

`520L` Set Point Output Low Limit: Select `0` to `100%` but not greater than `520H`. This item limits the lowest output value. This is useful for adding a bias to the process when needed. Factory set to `0` for output codes 1 and 3. Factory set to `20` for output code 5 (20% output equals 4 mA output).

`520H` Set Point 2 Output High Limit: Select `0` to `100%` but not less than `520L` for output codes 1 and 3. Select `0` to `102%` but not less than `520L` for output code 5. This item allows setting the maximum output limit. This is useful with processes that are over powered. Adjustment to 102% allows setting current output to force a full on condition for output devices which do not have bias adjustments. Factory set to `100` for all output codes.

If `0u+2` is set to `0nOF` (in the Secondary Menu), then the next three menu items can make the `SP2` and `SP2d` settings act like a high or low alarm set point. See the information on alarm settings and the cautions and warnings that apply to them on the next pages.

Note that when Set Point 2 Power Interrupt, `52Pi` is `0n`, and Set Point 2 Reset, `52rE`, is programmed to `Hold`, the `SP2` output will automatically reset upon a power failure and subsequent restoration, if the process is below `SP2`.

- SP2rE Set Point 2 Reset. Select 0n0F or Hold.
- 0n0F Output will automatically reset when process passes back through SP2d.
 - Hold Manual Reset. Reset (acknowledge) by simultaneously pressing the   INDEX & DOWN ARROW keys for 3 seconds.
- SP2Pi Set Point 2 Power Interrupt. Select 0n or 0FF.
- 0n Alarm Power Interrupt is 0n. Output will automatically reset on power-up if no alarm condition exists.
 - 0FF Alarm Power Interrupt is 0FF. Output will be in the alarm condition on power-up regardless of condition of process.
- SP2iH Set Point 2 Inhibit: Select 0n or 0FF.
- 0n Alarm Inhibit is 0n. Alarm action is suspended until the process value first enters a non-alarm condition.
 - 0FF Alarm Inhibit is 0FF.
- SP2LP Set Point 2 Lamp: Select 0on or 0oFF.
- 0on Lamp ON when Output is ON.
 - 0oFF Lamp OFF when Output is ON.

ALARM TYPE AND ACTION (if alarm function is present)



Caution: In any critical application where failure could cause expensive product loss or endanger personal safety, a redundant limit controller is required.

When setting an alarm value for an absolute alarm (R1+ = ABS), simply set the value at which the alarm is to occur.

When setting the alarm value for a deviation alarm (R1+ = dE), set the difference in value from the Set Point desired. For example if a low alarm is required to be 5 degrees below the Set Point, then set R1Lo to -5. If a high alarm is required 20 degrees above the Set Point, then set R1Hi to +20. If the Set Point is changed, the alarm will continue to hold the same relationship as originally set.

The diagram below shows the action and reset functions for both absolute and deviation alarms.

ABSOLUTE ALARMS

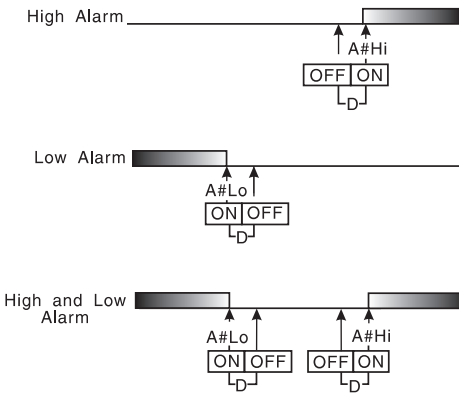

DEVIATION ALARMS

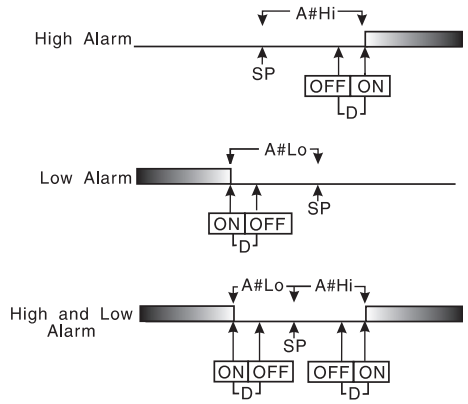

$$D = 1 \text{ degree F, } 1 \text{ degree C, or } 1 \text{ count.}$$

Note that when Alarm Power Interrupt, $AlPi$, is programmed ON and Alarm Reset, $AlrE$, is programmed for $Hold$, the alarm will automatically reset upon a power failure and subsequent restoration if no alarm condition is present.

If Alarm Inhibit, $AlIH$, is selected ON , an alarm condition is suspended upon power up until the process value passes through the alarm set point once. Alarm inhibit can be restored as if a power up took place by pressing both the  **INDEX** & **ENTER** keys for 3 seconds.



WARNING: IF INHIBIT IS ON AND A POWER FAILURE OCCURS DURING A HIGH ALARM, RESTORATION OF POWER WILL NOT CAUSE THE ALARM TO OCCUR IF THE PROCESS VALUE DOES NOT FIRST DROP BELOW THE HIGH ALARM SETTING. DO NOT USE THE ALARM INHIBIT FEATURE IF A HAZARD IS CREATED BY THIS ACTION. BE SURE TO TEST ALL COMBINATIONS OF HIGH AND LOW ALARM INHIBIT ACTIONS BEFORE PLACING CONTROL INTO OPERATION.

The following menu items apply only to the alarm.

- AL1** Alarm 1 function: Select OFF , Lo , Hi , $HiLo$, or $EUnt$.
- OFF Alarm 1 is disabled. No Alarm 1 menu items appear in the Secondary or Secure menus.
 - Lo Low Alarm Only. $AlLo$ appears in the Secondary Menu.
 - Hi High Alarm Only. $AlHi$ appears in the Secondary Menu.
 - $HiLo$ High and Low Alarms. Both $AlLo$ and $AlHi$ appear in the Secondary Menu, and share the same Alarm 1 Relay output.
 - $EUnt$ Alarm 1 is controlled by the Ramp/Soak program function. See pages 15-18 and 29 ($\#Al$) for further information.



If AL1 is set to OFF goto AL2 (next page).

If AL1 is set to EUn+, go to A15+ below.

- A1+ Alarm 1 Type: Select ABS or dE
ABS Absolute Alarm that may be set anywhere within the values of SCAL and SCRH and is independent of SP1.
dE Deviation Alarm that may be set as an offset from SP1. As SP1 is changed the Alarm Point will track with SP1. A deviation alarm will also track any active ramp or soak set point.
- A1rE Alarm 1 Reset: Select OnOF or Hold.
OnOF Automatic Reset.
Hold Manual Reset. Reset (acknowledge) by simultaneously pressing the   **INDEX & DOWN ARROW** keys for 3 seconds.
- A1Pi Alarm 1 Power Interrupt: Select On or OFF.
On Alarm Power Interrupt is On.
OFF Alarm Power Interrupt is OFF.
- A1iH Alarm 1 Inhibit: Select On or OFF.
On Alarm Inhibit is On. Alarm action is suspended until the process value first enters a non-alarm condition.
OFF Alarm Inhibit is OFF.
- A15+ Alarm 1 Output State: Select CLoS or OPEn.
CLoS Closes Contacts at Alarm Set Point.
OPEn Opens Contacts at Alarm Set Point.
- A1LP Alarm 1 Lamp: Select On or OFF.
On Alarm Lamp is ON when alarm contact is closed.
OFF Alarm Lamp is OFF when alarm contact is closed.
- A1Lb Alarm 1 Loop Break. Select On or OFF.
On Loop Break Condition will cause an Alarm Condition.
OFF Loop Break will not affect the Alarm Condition.
- AL2 Alarm 2 function: Select OFF, Lo, Hi, HiLo, or EUn+.
OFF Alarm 2 is disabled. No Alarm 2 menu items appear in the Secondary or Secure menus.
Lo Low Alarm Only. ALLo appears in the Secondary Menu.
Hi High Alarm Only. ALHi appears in the Secondary Menu.
HiLo High and Low Alarms. Both ALLo and ALHi appear in the Secondary Menu, and share the same Alarm Relay output.
EUn+ Alarm 2 is controlled by the Ramp/Soak program function. See pages 15-18 and 29 (#A2) for further information.



If AL2 is set to OFF and the control is not equipped with options, the Secure Menu ends here. If AL2 is set to OFF and the control is equipped with options, proceed to SP5A, Addr., or r5CL below.

If AL2 is set to EUn+, go to A25+ below.

- A2+ Alarm 2 Type: Select Ab5 or dE
Ab5 Absolute Alarm that may be set anywhere within the values of SCAL and SCRAH and is independent of SP1.
dE Deviation Alarm that may be set as an offset from SP1. As SP1 is changed the Alarm Point will track with SP1. A deviation alarm will also track any active ramp or soak set point.
- A2rE Alarm 2 Reset: Select OnOFF or Hold.
OnOFF Automatic Reset.
Hold Manual Reset. Reset (acknowledge) by simultaneously pressing the   **INDEX & DOWN ARROW** keys for 3 seconds.
- A2Pi Alarm 2 Power Interrupt: Select On or OFF.
On Alarm Power Interrupt is On.
OFF Alarm Power Interrupt is OFF.
- A2iH Alarm 2 Inhibit: Select On or OFF.
On Alarm Inhibit is On. Alarm action is suspended until the process value first enters a non-alarm condition.
OFF Alarm Inhibit is OFF.
- A25+ Alarm 2 Output State: Select CL05 or OPEn.
CL05 Closes Contacts at Alarm Set Point.
OPEn Opens Contacts at Alarm Set Point.
- A2LP Alarm 2 Lamp: Select On or OFF.
On Alarm Lamp is ON when alarm contact is closed.
OFF Alarm Lamp is OFF when alarm contact is closed.
- A2Lb Alarm 2 Loop Break. Select On or OFF.
On Loop Break Condition will cause an Alarm Condition.
OFF Loop Break will not affect the Alarm Condition.



- SPSR** (Option 948, 4-Stage Set Point) Switch Action: Select rE or In†.
- rE Set Point Stage selected by external contact closures.
- In† Set Point Stage selected by internal menu selection. See SP menu item in Secondary Menu.
- Addr** (Option 992, 993, 995, 996, Serial Communications) Control Address: Set from 1 to 3FF for Options 992 and 993. Set from 1 to FF for Options 995 and 996. This number (hexadecimal, base 16) must match the address number used by the host computer. Power to instrument must be turned off and on before change takes effect (see Page 21).
- BAUD** (Option 992, 993, 995, 996, Serial Communications) Communication Baud Rate: Select 300, 1200, 2400, 4800, 9600 (baud), 19.2, or 28.8 (kbaud) This number must match the baud rate used by the host computer. Power to instrument must be turned off and on before change takes effect (see Page 21).
- nRT** (Option 992, 993, 995, 996, Serial Communications) No Activity Timer: Select 0FF or 1 to 99 minutes.
- 1 - 99 Maximum time between host computer accesses. If the timer counts to 0, CHECK LoFE will be displayed.
- 0FF No Activity Timer function is disabled.
- Stor** (Option 992, 993, 995, 996, Serial Communications) Store to EEPROM: Select YES or no. (See additional information on pages 22-23).
- YES Menu Item changes made through the Serial Communications are stored directly to the EEPROM.
- no Menu Item changes made through the Serial Communications are stored in RAM.
- rSCL** (Option 924, 926, 928, Analog Remote Set Point) Remote Scale Low: Select 100 to 11998 counts below rSCH. The total span between rSCL and rSCH must be within 11998 counts. Maximum setting range is -1999 to +9999 counts.
- rSCH** (Option 924, 926, 928, Analog Remote Set Point) Remote Scale High: Select 100 to 11998 counts above rSCL. The total span between rSCL and rSCH must be within 11998 counts. Maximum setting range is -1999 to +9999 counts.

ERROR MESSAGES

Any error message may be cleared by using the 'Global Reset' by pressing and holding the   INDEX & ENTER keys for five seconds.

Display	Meaning	SP Outputs	Action Required
R-ER (Alternates with PV)	This message appears if the ambient temperature of the control approaches the ends of tolerance.	Set point outputs active Alarm active	Correct the ambient temperature conditions. Ventilate the area of the cabinet or check for clogged filters. If internal temperature sensor (RJC located in terminal 2) is broken, return to factory for service.
R-ER	This message appears if the ambient temperature of the control is out of range or RJC sensor is broken	Set point outputs active Alarms active	Correct the ambient temperature conditions. Ventilate the area of the cabinet or check for clogged filters. If internal temperature sensor is broken, return to factory for service.



ERROR MESSAGES

Any error message may be cleared by using the 'Global Reset' by pressing and holding the   INDEX & ENTER keys for five seconds.

Display	Meaning	SP Outputs	Action Required
UFL or OFL	Underflow or Overflow: Process value has exceeded input range ends. UFL or OFL will sequence to display one of these messages if the I_{nP+} is set for a time value.	Set point outputs active Alarm active	May be normal if Input signals go above or below range ends. If not the case, check sensor, input wiring and correct. When I_{nP+} (input fault timer) has been set for a time, the outputs will be turned off after the set time. Setting the time to OFF causes the outputs to remain active, however UFL or OFL will still be displayed.
bAd I_{nP}	For RTD inputs RTD is open or shorted.		Correct or replace sensor.
OPEn I_{nP}	For THERMOCOUPLE inputs thermocouple is open.		Correct or replace sensor. Clear with 'Global Reset'.
LOOP bAd	The sensor may be defective, heater fuse open, heater open, or the final power output device is bad.	Set point outputs inactive. Alarm active.	Correct or replace sensor, or any element in the control loop that may have failed. Correct the problem. Clear with 'Global Reset'
SEnC bAd	Sensor Rate of Change exceeded the programmed limits set for SEnC.	Set point outputs inactive. Alarm active	Check for the cause of the error. The value setting may be too slow for the process, or the sensor is intermittent. Correct the problem. Clear with 'Global Reset'.
CHEC CAL	Check calibration appears as an alternating message if the instrument calibration nears tolerance edges. Check calibration appears as a flashing message if the instrument calibration exceeds specification.	Set point outputs active Alarm active Set point outputs inactive Alarm active	Remove the instrument for service and / or recalibration. Remove the instrument for service and / or recalibration.

ERROR MESSAGES

Any error message may be cleared by using the 'Global Reset' by pressing and holding the   INDEX & ENTER keys for five seconds.

Display	Meaning	SP Outputs	Action Required
No display lighted	Display is blank. Instrument is not getting power, or the supply voltage is too low.	Set point outputs inactive Alarm inactive	Check that the power supply is on, measure supply voltage, check that the external fuses are good.
FAIL +ES+	Fail test appears upon power up if the internal diagnostics detect a failure. This message may occur during operation if a failure is detected. Displays flash. Fail test may also occur due to an EEPROM failure.	Set point outputs inactive Alarm inactive	The display alternates between FAIL +ES+ and one of the following messages: FRC+ dFL+: Memory may be corrupted. Press the   DOWN ARROW & ENTER keys to return control to the factory default settings. Recheck controller programming. rE+ FRC+: Unrecoverable error, return to factory for service.
CHEC SP1, CHEC SP2, CHEC 1SP, ..., CHEC 1bSP,	This message will appear upon power up if SP1, SP2, #SP1, or ##SP is set outside of the SPL or SPH values.	Set point outputs inactive Alarm active	Correct the SP1, etc. or adjust the SPL or SPH values by programming new values.
CHEC SPL or CHEC SPH	This message appears at power up if SPL or SPH values are programmed outside the input range ends.	Set point outputs inactive Alarm active	Correct the SPL or SPH values by programming new values.
CHEC rSp+	This message appears if the analog remote set point signal is out of range.	Set point outputs active Alarm active	The control will revert to SP1. Correction of the analog signal or turning OFF the rSp+ clears the error message.
CHEC LoRE	This message appears if the Serial Communications has timed out.	Set point outputs active Alarm active	Change the LoRE to LDC. Restore the communications line and switch LoRE back to rE.

CONFIGURATION MENU



DO NOT ENTER THE CONFIGURATION MENU UNLESS YOU HAVE BEEN INSTRUCTED TO BY THESE INSTRUCTIONS. INCORRECT ENTRY OF DATA IN THE CONFIGURATION MENU MAY CAUSE IMPROPER OR UNPREDICTABLE OPERATION OF THE INSTRUMENT.

The Configuration Menu is used to quickly recover the instrument after certain Error Codes. The configuration for your particular model is shown on the Model / Serial label located on the left side (when viewed from the front) of the instrument housing. A label found inside on the right side of the chassis shows the same information.

If you do recover the instrument from a **FRL +E+** error, the memory configuration is restored to the factory settings. All hardware inputs and outputs are automatically recognized except for Options 924, 926, and 928.

If you have a instrument equipped with one of these options, Factory Default will not automatically restore these settings. They must be set by hand.

To re-configure:

1. At power up, simultaneously press and hold the **INDEX & ENTER** keys while the lamp test or self test is displayed. Hold the keys down until the ROM ID code appears.
2. Press the **INDEX** key to advance to the next menu item, **FRC + dFL +**. This function restores the control to original factory settings. It will also remove all of the hardware, option, and software configuration values. After selecting **FRC + dFL +** you will need to restore the configuration values as shown above to allow the instrument to operate correctly.

To restore factory default values, press and hold the **ENTER** key. While holding the **ENTER** key also press the **DOWN ARROW** key. The display will blink momentarily and the instrument will reboot. The instrument will then display the ROM ID. Press **INDEX** to step through **FRC + dFL +** and continue at step 3.

3. Press **INDEX** to **OP+1**. If your instrument is equipped with Option 924, 926, or 928, press the **UP ARROW** or **DOWN ARROW** as necessary to display **r5P+**. The display will be flashing. To select, press **ENTER** while **r5P+** is displayed. When selected, the option number will stop flashing.



DO NOT SELECT AN OPTION IF THE INSTRUMENT DOES NOT HAVE THE HARDWARE TO SUPPORT IT. SELECTION OF AN UNSUPPORTED OPTION MAY CAUSE IMPROPER OR UNPREDICTABLE OPERATION OF THE INSTRUMENT.

4. Press INDEX to CONF1.
5. Press INDEX to REPT+. If you do not want to retain the re-configuration, this is your last chance to return to the old configuration. Press ENTER at REPT+ NO to exit and retain the old configuration. Otherwise, press UP ARROW and ENTER at REPT+ YES to retain the new configuration.
6. The instrument will re-boot with factory settings.

SPECIFICATIONS

Selectable Inputs: Thermocouple, RTD, DC Voltage, or DC Current selectable.

Input Impedance:

Thermocouple = 3 megohms minimum.

RTD current = 200 μ A.

Current = 10 ohms.

Voltage = 5000 ohms.

Sensor Break Protection: De-energizes control output to protect system after customer set time. (See I_{nP+} in Secure Menu.)

Set Point Range: Selectable (See Input Ranges Page 49).

Display: Two 4 digit, 7 segment 0.56" high LEDs.

Control Action: Reverse (usually heating), Direct (usually cooling) selectable.

Proportional Band: 1 to 9999°F, °C, or counts.

Reset Time (Integral): Off or 0.1 to 99.9 minutes.

Rate Time (Derivative): Off or 0.01 to 99.99 minutes.

Cycle Rate: 1 to 80 seconds.

On - Off Differential: Adjustable 1°F, 1°C, or 1 count to full scale in 1°F, 1°C, or 1 count steps.

Alarm On - Off Differential: 1°F, 1°C, or 1 count.

Fuzzy Percent: 0 to 100%.

Fuzzy Rate: Off or 0.01 to 99.99 counts per second.

Fuzzy Band: Off or 1 to 4000 °F, °C, or counts.

Accuracy: $\pm 0.25\%$ of span, ± 1 least significant digit.

Resolution: 1 degree or 0.1 degree, selectable.

Line Voltage Stability: $\pm 0.05\%$ over the supply voltage range.

Temperature Stability: 100 ppm /°C typical, 200 ppm /°C maximum.

Common Mode Rejection: 140 db minimum at 60 Hz.

Normal Mode Rejection: 65 db typical, 60 db at 60 Hz.

Isolation:

Relay and SSR outputs: 1500 Vac to all other inputs and outputs;

SP1 and SP2 Current outputs: 500 Vac to all other inputs and outputs, but not isolated from each other;

SP1 and SP2 Switched Voltage outputs: 500 Vac to all other inputs and outputs, but not isolated from each other.

24 VDC Loop Power: 500VAC to all inputs and outputs.

Supply Voltage: 100 to 240 Vac, nominal, +10 -15%, 50 to 400 Hz. single phase; 132 to 240 VDC, nominal, +10 -20%.

Loop Power Supply: 24 VDC @ 50 mA, regulated.

Power Consumption: 5VA maximum.

Operating Temperature: -10 to +55°C (+14 to 131°F).

Storage Temperature: -40 to +80°C (-40 to 176°F).

Humidity Conditions: 0 to 90% up to 40°C non-condensing, 10 to 50% at 55°C non-condensing.

Memory Backup: Nonvolatile memory. No batteries required.

Control Output Ratings:

SSR: 2.5 A @ 240 Vac at 25°C (77°F). Derates to 1.25 A @ 55°C (130°F);

Relay: SPDT, 10 A @ 240 VAC resistive; 1/2 hp @ 120 VAC or 1/3 hp @ 240 VAC;

Alarm Relay: SPST, 3 A @ 240 VAC resistive; 1.5 A @ 240 VAC inductive. Pilot Duty Rating: 240 VA, 2A @ 120 VAC or 1A @ 240 VAC.

Current (isolated): 0 to 20 mA across 600 ohms maximum.

Switched Voltage (isolated): 15 VDC @ 20 mA.

Panel Cutout: 92 mm x 92 mm (3.625" x 3.625").

Depth Behind Mounting Surface: 103 mm (4.0") maximum.

Weight: 454 g (16 oz).

Agency Approvals: UL, C-UL E83725; CE.

Front Panel Rating: IP66, (UL Type 4X).

OPTIONS

-924 Analog Remote Set Point

Input: 0 to 10 VDC

Input Impedance: 1 Meg Ohms

Isolation: Shares common ground with PV input.

Scale: Programmable from 100 to 11998 counts, depending on PV range selected.

-926 Analog Remote Set Point

Input: 0 to 20 mADC.

Input Impedance: 10 Ohms

Isolation: Shares common ground with PV input.

Scale: Programmable from 100 to 11998 counts, depending on PV range selected.

-928 Analog Remote Set Point

Input: 0 to 10,000 ohms, two wire.

Search Current: 4 μ A.

Isolation: Shares common ground with PV input.

-934 Analog Retransmission of PV/SV (programmable)

Output: 0 to 20 mADC into 600 Ohms, maximum.

Isolation: 500 VAC

Scale: Programmable from 100 to 11998 counts, depending on PV range selected.

-936 Analog Retransmission of PV/SV (programmable)

Output: 0 to 10 VDC @ 20 mA maximum.

Isolation: 500 VAC

Scale: Programmable from 100 to 11998 counts, depending on PV range selected.

-948 Four Stage Set Point

Input: Dry contact or Transistor switch (NPN open collector type).

Current: 1 mADC.

Isolation: Shares common ground with PV input.

-992 RS-485 Series Communications

Port Compliance: EIA-485

Isolation: 500 VAC

Protocol: Lovelink™ II

Address Range: 001H to 3FFH

Baud Rates: 300, 1200, 2400, 4800, 9600, 19.2k, 28.8k.

Mode: Half duplex

Character: 8 bits, 1 start, 1 stop, no parity.

Number of units on line/port¹: 32.

Cable Length¹: 6,000 ft (1,828 m).

Termination: 120 Ohms, balanced.

-993 RS-232 Serial Communications

Port Compliance: RS-232C

Isolation: 500 VAC

Protocol: Lovelink™ II

Address Range: 001H to 3FFH

Baud Rates: 300, 1200, 2400, 4800, 9600, 19.2k, 28.8k.

Mode: Half duplex

Character: 8 bits, 1 start, 1 stop, no parity.

Number of units on line/port¹: 1.

Cable Length: 25 ft (7.6 m).

-995 RS-232 Serial Communications

Port Compliance: RS-232C

Isolation: 500 VAC

Protocol: MODBUS® RTU

Address Range: 001H to 0FFH

Baud Rates: 300, 1200, 2400, 4800, 9600, 19.2k, 28.8k.

Mode: Half duplex

Character: 8 bits, 1 start, 1 stop, no parity.

Number of units on line: 1.

Cable Length: 25 ft (7.6 m).

-996 RS-485 Serial Communications

Port Compliance: EIA-485

Isolation: 500 VAC

Protocol: MODBUS® RTU

Address Range: 001H to 0FFH

Baud Rates: 300, 1200, 2400, 4800, 9600, 19.2k, 28.8k.

Mode: Half duplex

Character: 8 bits, 1 start, 1 stop, no parity.

Number of units on line¹: 32

Cable Length¹: 6,000 ft (1,828 m).

Termination: 120 Ohms, balanced.

¹ Number can be increased through use of a repeater such as the Mother Node™.

Consult factory for details.

Lovelink™, Lovelink™II, and Mother Node™ are Trademarks of Love Controls. MODBUS® is a trademark of Schneider Automation.

INPUT RANGES

INPUT TYPE	RANGE °F	RANGE °C
Type J or L ¹ Thermocouple	-100 to +1607	-73 to +871
Type K ¹ Thermocouple	-200 to +2500	-129 to +1371
Type T ¹ Thermocouple	-350 to +750	-212 to +398
Type E ¹ Thermocouple	-100 to +1800	-73 to +982
Type R Thermocouple	0 to 3200	-17 to +1760
Type S Thermocouple	0 to 3200	-17 to +1760
Type B Thermocouple	+75 to +3308	+24 to +1820
Type C Thermocouple	0 to 4208	-17 to +2320
Type N ¹ Thermocouple	-100 to +2372	-73 to +1300
100 Ω Plt. 0.00385 DIN ¹ RTD	-328 to 1607	-200 to +875
100 Ω Plt. 0.00392 NIST ¹ RTD	-328 to 1607	-200 to +875
120 Ω Nickel 0.00628 US ¹ RTD	-112 to +608	-80 to +320
1000 Ω Plt. 0.00385 DIN ¹ RTD	-328 to +1607	-200 to +875
Current/Voltage/Δ Voltage ²	Scalable Units from -1999 to +9999	

¹ These Input Types can be set for 0.1° display. If temperature goes above 999.9° or less than -199.9° the display will return to whole degree resolution.

² The 0 to 20 mADC, 4 to 20 mADC, 0 to 10 VDC, 2 to 10 VDC, and -10 to +10 mVDC inputs are fully scalable from a minimum of 100 counts span placed anywhere within the within the range of -1999 to +9999. Decimal point position is adjustable from the zero place (9999), tenths (999.9), hundredths (99.99), thousandths (9.999), or ten thousandths (.9999).

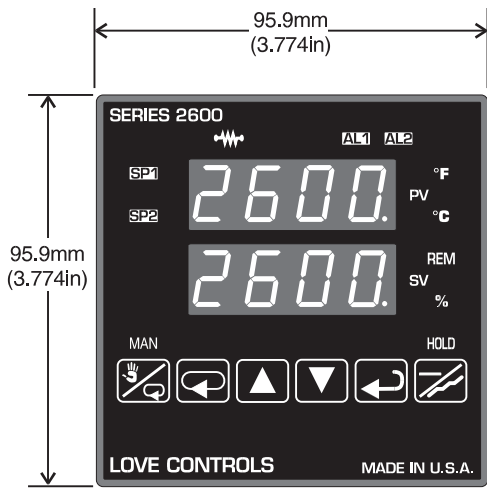

Meets IP66 (UL Type 4X)

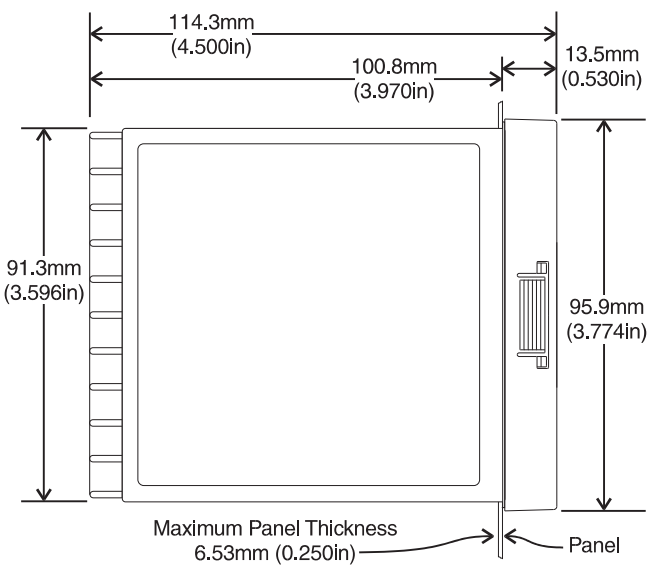

All dimensions are in millimeters with inches in parenthesis.
 Panel cutout for all models is 92mm x 92mm (3.625in x 3.625in).
 Allow for 13mm (0.5in) clearance at the rear of the instrument.

